

The CLT Handbook

CLT structures – facts and planning

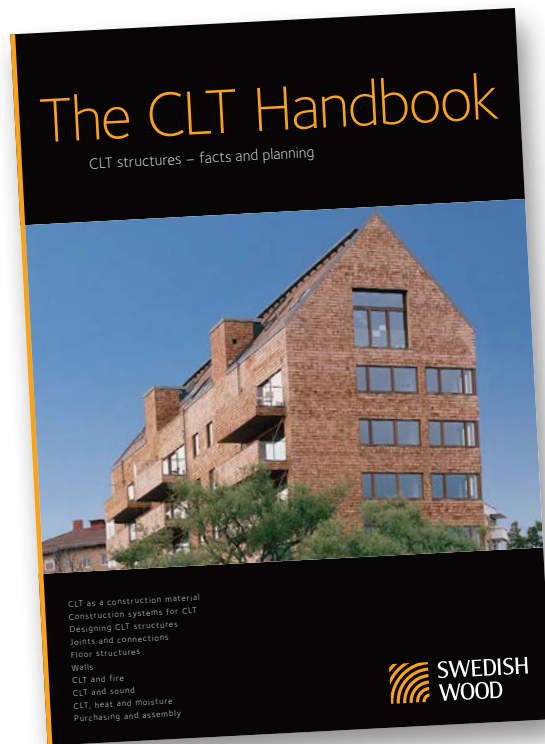



The CLT Handbook is the result of a collaboration between Swedish suppliers of cross laminated timber, CLT, and the industry body Swedish Wood. The CLT Handbook is part of Swedish Wood's investment in handbooks for building in wood. Other handbooks that have been published are:

- Design of timber structures Volume 1, which deals with structural aspects of timber constructions.
- Design of timber structures Volume 2, which contains rules and formulas according to Eurocode 5. Design of timber structures Volume 3, which include examples of timber constructions.
- The Glulam Handbook Volume 1, which deals with facts about glulam and planning guidance.
- The Glulam Handbook Volume 2, which contains calculations for the structural dimensioning of glulam.
- The Glulam Handbook Volume 3, which gives a number of example calculations for the most common glulam structures.

Further knowledge, information and practical instructions on wood, CLT and timber construction is available on TräGuiden, www.traguiden.se, which is constantly updated with new knowledge and practical experiences. TräGuiden is an extensive resource with tables, drawings and illustrations.

Welcome to www.traguiden.se!

Information on wood, glulam, CLT and timber construction can also be found at www.svenskttra.se.

Stockholm, May 2019

Eric Borgström and Johan Fröbel
Svenskt Trä

Foreword

The aim of the CLT Handbook is to help construction planners to design and plan structures using panels of cross laminated timber. The handbook describes cross laminated timber, CLT, as a construction material, as well as designs carried out using CLT. The CLT Handbook provides guidance on designing and planning structures in CLT. The CLT Handbook also presents some of today's many applications for CLT. The CLT Handbook is aimed at construction planners and other actors in the field.

The CLT Handbook refers mainly to European construction standards and the Eurocodes, which are Europe-wide structural design rules that address verification of load-bearing capacity, stability and durability. National adaptations have been made to the Eurocodes, based on the member states' particular conditions with regard to geology, climate and culture. These national adaptations for Sweden are set out in Boverket's building regulations (BBR) and its general recommendations on the application of European design standards, EKS 10 (BFS 2015:6). EKS 10 also contains general rules on safety, controls, documentation and changes to buildings.

Where the Swedish EKS 10 lacks rules or presents questionable design methods, other methods have been suggested. When calculating the properties and load-bearing capacity of CLT in different contexts, methods based on research and best practice have therefore been used.

The authors have been responsible for interpreting building regulations, research papers, industrial documents and so on, with a view to conveying current design practices. The material presented is only intended to provide guidance; the final design responsibility lies with the structural engineer.

Skellefteå, May 2019

Anders Gustafsson
RISE Research Institutes of Sweden



Installing CLT

Table of contents

CLT as a construction material 8

- 1.1 Introduction 8
- 1.2 Architect's views on CLT 9
- 1.3 CLT as a construction material 11
- 1.4 CLT in the eco-cycle 12
- 1.5 CLT manufacture 16
- 1.6 Properties 19
- 1.7 Where can you use CLT? 21

Design systems for CLT 24

- 2.1 Floor structures and walls 25
- 2.2 CLT as a beam 26
- 2.3 CLT in shell structures 26
- 2.4 Initial design 27

Design of CLT structures 30

- 3.1 Basis for design 30
- 3.2 Material properties of CLT 37
- 3.3 CLT design using beam theory 40
- 3.4 CLT as two-dimensional load-bearing slabs or panels 63
- 3.5 Design software for CLT 67
- 3.6 Examples 68

Joints and connections 72

- 4.1 Joints and connections 72
- 4.2 Design principles 73
- 4.3 Overview of joint types 74
- 4.4 Detailed solutions 75
- 4.5 Designing of connections 80

Floor structures 90

- 5.1 Floor structures – overview 91
- 5.2 Deformations 94
- 5.3 Deflection, sagging and vibrations 97
- 5.4 Fire safety 101
- 5.5 Acoustic performance 101
- 5.6 Example calculations 106

Walls 110

- 6.1 Walls – overview 111
- 6.2 Static design 112
- 6.3 Structure stability 115
- 6.4 Fire 121
- 6.5 Acoustic 121
- 6.6 Wall cross-sections 123
- 6.7 Design and detailed solutions 124
- 6.8 Example calculations 127

CLT and fire 133

- 7.1 Wood and fire safety 133
- 7.2 Fire resistance of CLT 138
- 7.3 Design and details 140
- 7.4 Example 141

CLT and sound 145

- 8.1 Planning for acoustics 145
- 8.2 Acoustics in CLT structures 151
- 8.3 Floor structures 151
- 8.4 Walls 154
- 8.5 Points to bear in mind 156

CLT, heat and moisture 157

- 9.1 CLT and thermal storage, moisture buffering 157
- 9.2 CLT and moisture-related movement 160
- 9.3 CLT and thermal insulation 160

Purchasing and assembly 164

- 10.1 Enquiry and purchasing 164
- 10.2 Handling CLT correctly 164
- 10.3 Protecting the structure during construction 170
- 10.4 Points to bear in mind 174

Symbols 176

References 181

Non-liability 184

Swedish Wood publications and websites 187



CLT as a construction material

1.1	Introduction	8
1.2	Architect's view of CLT	9
1.3	CLT as a construction material	11
1.4	CLT in the eco-cycle	12
1.5	CLT manufacture	16
1.5.1	Certified CLT	18
1.6	Properties	19
1.6.1	Strength properties	19
1.6.2	Thermal properties	19
1.6.3	Moisture-related movement	20
1.6.4	Burning properties	20
1.6.5	Surface layer and surface treatment	20
1.7	Where can you use CLT?	21

1.1 Introduction

Cross laminated timber, crosslam, CLT, X-Lam, BSP, mass timber and multiply are common names for sheets, panels, posts and beams made of glued boards or planks layered alternately at right-angles. For the CLT Handbook, we have decided to use the term cross laminated timber and the abbreviation CLT. The clear majority of the CLT bought in the Nordic countries is used as structural components in the frames of multi-storey buildings, schools, nurseries, industrial premises, houses and special structures. Since CLT is a versatile product, it could also be used in a broad spectrum of applications. CLT are currently used primarily for walls and floor structures. CLT is an eco-friendly and recyclable construction material that, used correctly, has a long service life. It can then be reused in new structures or incinerated for energy recovery.

The distinguishing feature of CLT structural components such as walls and floors is that they are often used as large surface panels. The opportunity for sizeable cross-sections gives the components a high load-bearing capacity and stiffness, which also makes the panels useful for stabilising the building. The panels can be manufactured with a high degree of prefabrication and their low self-weight brings benefits in terms of groundwork, transport and assembly. The insulation in an outer wall can largely be placed almost alongside without any thermal bridges. The solid structure and the cladding material usually used also provide good fire safety.

Modern manufacturing techniques combined with good strength properties make CLT a useful construction material with unique properties:

- The flexibility of CLT makes a valuable contribution to the development of construction.
- High strength in relation to the self-weight of the material.
- Small manufacturing tolerances and good dimensional stability.
- Good load-bearing capacity in fire.
- Good thermal insulation capacity.
- Low self-weight, which means lower transport and assembly costs, as well as lower foundation costs.
- Good capacity to tolerate chemically aggressive environments.
- Flexible production that even allows the manufacture of curved surfaces.

CLT structures are characterised by fast and simple assembly of prefabricated surface and box units. The components can be joined using simple and traditional methods such as nailing and screwing.

For more demanding structures, there are more advanced fixing methods.



Cabin, Kebnekaise, Sweden.

A CLT structure has full load-bearing capacity even before assembly and, as with other timber structures, minor changes can be made on-site using simple hand tools. Wood has been used in buildings for centuries and is a material with extremely good durability if used correctly. The Nordic countries have examples of wooden buildings that are hundreds of years old!

1.2 Architect's view of CLT

It is said that forward-looking politicians in the alpine countries of Europe came up with the idea of developing wood for modern construction.

The question was: can we make a construction material from the trees lining our valleys, rather than scraping ballast from the slopes and river beds to produce concrete? This question was sent out to the leading universities in Austria and a few years later, in the late 1990s, researchers unveiled Kreuzlagerholz, KLH, or CLT in English. This marked the birth of a new construction material based on a climate-smart and ecological approach. An engineered construction material that makes use of a raw material that is constantly growing and renewable.

Now the world of construction had a material for architecture and urban development that offered an alternative to stone, brick, steel and concrete. Of course, wood is nothing new in building. Frames of vertical and horizontal timber have formed solid walls in homes since time immemorial. Post-and-plank structures, with horizontal planks between posts, were developed when access to logs became commercialised. Vertical planks and posts were an early method for creating self-build homes of up to two floors. People have always had an affinity with wood as a construction material, as it can be crafted with all kinds of tools.

CLT allows for large-format wooden panels – it is possible to manufacture panels up to 4.80 m tall and 30 m long, with thicknesses of around 60 – 500 mm. This enables architects to design a building that comprises flat packs of prefabricated panels with precision holes cut out for windows, doors and installations, which are then assembled on the construction site. We are talking about industrial production, under cover, with time-saving assembly on site. This is also the case with the manufacture of box units, where floors, walls and ceilings are produced in CLT.

CLT is an engineered material that can be used for architecture in an industrialised way, with extensive prefabrication of components. Elements based on wood can be processed all the way to the detailing and surface finish. With modern digital technology offering new choices and incredible precision, the construction world is no longer tied to the site-bound, suboptimal building culture.

CLT furnishes interiors with surfaces that are ready to use. The floor is pleasant to walk on, since wood immediately conveys warmth to bare feet. Shelves can be screwed onto the walls without any problem. Pictures can be hung, and things can be fixed to the ceiling with no fuss. If the resident wants to add a doorway, there is usually plenty of freedom to saw a new opening, where appropriate. And adding a new window for extra daylight is generally just as straightforward.

CLT panels perform structurally like concrete components, but with much lower self-weight. In terms of calculations, CLT counts as a fully fledged structural sheet material, with known stresses from



Ventilation tower with CLT frame, Stockholm, Sweden.



Summer house under construction, Öland, Sweden.



Summer house made of CLT, Öland, Sweden.

compression, tensile and shear forces in buildings. Issues of fire safety can also be addressed, based on recognised research and development as well as European standards.

In the event of a fire, the cross laminated timber panel chars on the surface to create a protective layer, while retaining structural integrity, so that people can be moved to safety in good time.

With all the excellent properties that CLT displays, it can be used with confidence as a construction material. People have long put their trust in wood. Our senses were no doubt trained up in woodwork, where a direct relationship with the material could be established.

The architecture we want for our cities in the future will be built around CLT frames. We are often keen to see that buildings are made of wood, with exposed wooden surfaces. It is now perfectly possible to make the buildings rise over many floors. CLT can also form the load-bearing structure on the exterior, allowing for façades in a different material. It is all a matter of where the buildings fit into the cityscape and what local adaptations are required.

A useful option that CLT structures allow is densification, with new developments that slot comfortably into the existing built environment. Newbuilds assembled in kit form can be erected in a short space of time, and this time-saving construction method can be tailored well to local conditions.

Architecture that makes use of CLT can embrace a design language that is exciting and surprising, since wood conveys the spirit that architects and developers want for their projects, in terms of planning, function and appearance. Additional potential for CLT lies in new alliances with other materials, such as reinforced concrete, glass and steel.

Such composites can provide answers to structural challenges concerning floor structures and stability. Historically, timber-frame houses bear witness to the opportunities for the constructive combination of different materials.

A challenge for the future is to achieve energy-efficient cities with buildings that face the sun and generate their own energy. The fact that CLT forms a climate-smart carbon sink in structures, while allowing attractive solar panels to be mounted on the façade and roof, is good news for future architecture. And remember that various types of building in the cityscape can be made using CLT construction kits. The housing we need to build for the young, the old and new arrivals, city halls, schools, preschools, cultural centres, sports halls, bus and train depots, department stores and shopping centres, hotels and restaurants – all this architecture can be built around CLT.

A point always in its favour is that CLT advances the cause of industrial manufacture using a material that is renewable and easy to work with. It opens the way for an industry equipped with digital power and automation that can be used for products that benefit humanity, bringing diversity and rich experiences to architecture and urban planning. This is an architectural material that embodies our desire to make the planet more sustainable for us, our children and our children's children.

Finally. It has also been shown that people sleep better in rooms that use wood in floors, walls and ceilings – a material that breathes and maintains an active relationship with the seasons and relative humidity. Sustainably.

1.3 CLT as a construction material

Cross laminated timber, CLT, is a highly engineered wood product that is excellent for all sorts of different structures. CLT's composition and method of manufacture offer huge opportunities, since the panel can be glued and worked into almost any shape and size. Since the raw material is fully renewable, CLT has a good environmental profile.

Cross laminated timber has excellent strength and stiffness properties, which mean that CLT panels can compete with other more traditional structural materials in high-rise buildings. In relation to their own weight, CLT panels have a higher load-bearing capacity than most other construction materials, which is why large structures can be built to withstand high loads. Since the cross-section can take on any shape and the geometry of the panel can be varied, even bent into a plane curve, there are extensive opportunities to use wood in a new way. CLT is already being used in many different types of structure: houses, high-rise blocks, halls, sports arenas and bridges. With suitable designs and detailing, plus protection from the climate, possibly with a surface treatment, CLT can be used for these and many other structures.

CLT was introduced into Sweden as an engineered wood in the late 1990s, by which time Central Europe had been manufacturing CLT panels for several years. Among the first major developments in Sweden to use CLT was the Inre Hamnen in Sundsvall, which was completed in 2006. Since then, the technology has really taken off, so that now Sweden produces around 200,000 cubic metres of CLT panels each year. Sweden currently have four suppliers of CLT, and the use of CLT panels is growing year-on-year. Demand for and production of CLT is also rising in the rest of Europe and globally. It is predicted that by 2018, around 0.6 – 1 million cubic metres of CLT will be produced annually around the world, *see figure 1.1*.

Intensive research and development is currently underway regarding CLT manufacture and building with CLT. Developers and contractors almost everywhere in the world are also beginning to realise the potential of building with wood. In Vancouver, London, Milan and many other cities, housing, offices and public buildings, some up to 14 – 24 storeys high, are either in the planning or construction phase.



Inre Hamnen, Sundsvall, Sweden.

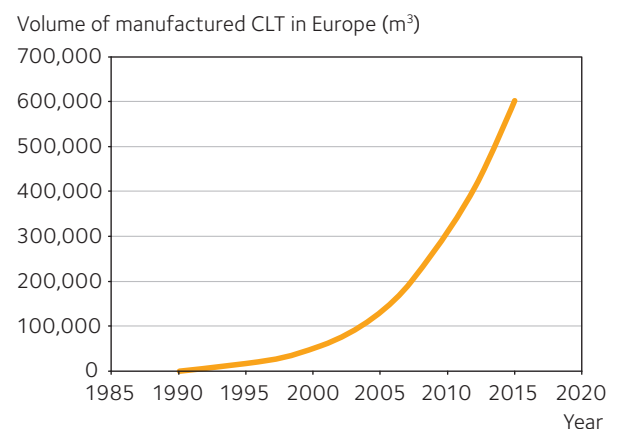

Figure 1.1 Development of CLT in Europe

1990 – 1995	Concepts, patents and proposals presented in European trade journals.
1996 – 2000	Prototypes and components developed for the Swedish market.
2000 – 2004	First deliveries for small-scale projects in Sweden.
2004 – 2005	First taller wooden buildings in CLT built in Sweden.
2005 – 2014	More and more projects built using CLT.
2015 –	Forecast for the whole of Europe.

1.4 CLT in the eco-cycle

Forests in Sweden are managed according to the principles of sustainable forestry. Use of wood is therefore beneficial from an environmental and climate point of view, compared with other construction materials. Firstly, manufacturing CLT is an energy efficient process. Secondly, the by-products (wood shavings and wood waste) are used to produce energy, which is used to heat the drying kilns, for example, thus reducing the need for fossil energy during manufacture. Sustainable forestry means that the extraction from the forest does not exceed growth, the raw material is constantly regenerated, and the wood can be returned to the eco-cycle without adding harmful greenhouse gases to the climate.

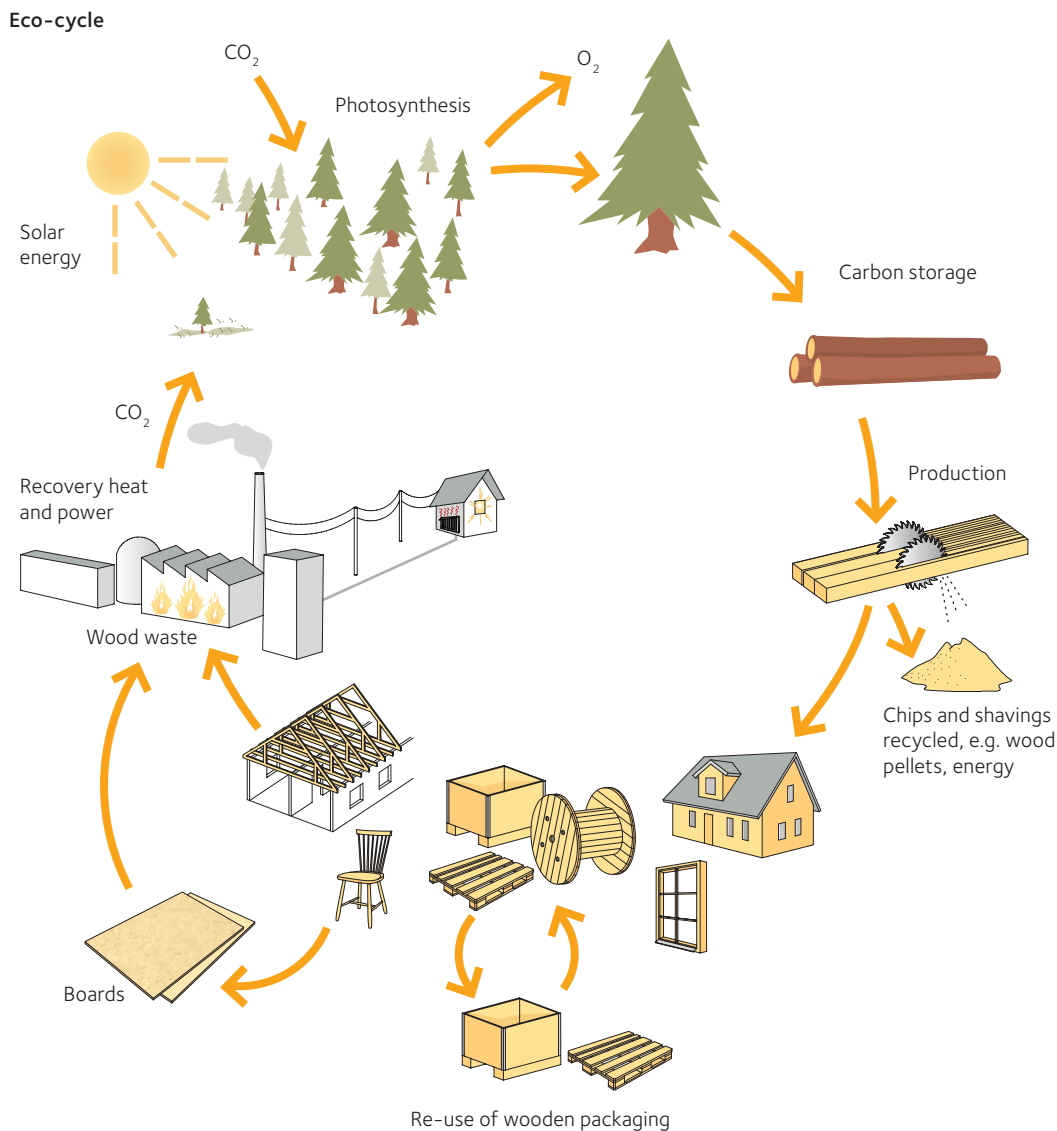

Figure 1.2 Eco-cycle of wood products

The eco-cycle comprises two parts. One relates to the forest and the other to the products. The forest gains its vitality from the sun. Through photosynthesis, solar energy is absorbed and reacts with carbon dioxide (CO₂) to produce nutrients for the growing trees. The forest's products contain carbon (C) that has been absorbed by the trees in the form of

carbon dioxide. The ecocycle of the products includes reuse, repair and recycling. When these products reach the end of their life, the carbon dioxide is released into the atmosphere as the waste decays or is recycled as bioenergy. The carbon dioxide is then again captured by the trees and converted into nutrients and new building blocks for their growth.

Building with wood is positive for the climate. To minimise the environmental impact of construction and to contribute to a sustainable society, every opportunity to use renewable materials must be seized with both hands. For the construction and property sector, this means considering the production and operational phase, both of which affect the environment. As solutions in the operational phase become increasingly energy-efficient, the manufacturing and building process takes on greater weight when judging the environmental impact of a building over its entire life. Life cycle analyses of built objects have shown that emissions can be reduced by using wood in the structural frame instead of other materials.

Standards and methods for assessing a building's environmental impact are based mostly around standards as ISO 9001 and ISO 14001. Then there are the standards for life cycle analyses (LCA). The standards provide an opportunity to document a building's sustainability over its lifetime, and in the building's different phases. *Table 1.1* states which parts of the construction process should be considered when assessing environmental impact.

As part of a European project, several life cycle assessments were carried out on a four-storey building that used different construction techniques. The models used in the study were a site-built timber-frame; a concrete frame, cast on site, with timber-frame curtain walls; box units with timber frame; surface units with load-bearing CLT panels; and glulam post and beam frame with timber-frame walls. The last three models were also modelled as a design that met the Swedish Boverket's Building Regulations (BBR) 2012, and as a design that met the passive house requirements set out by the Forum for Energy-efficient Buildings (FEBY). The calculations related to a complete model of the building, including the foundation slab, but excluding interior fittings and lifts.



Spruce plant.

Table 1.1 Environmental assessment of a building.

Life cycle information about the building				Other information
A 1-3 Production	A 4-5 Construction	B 1-7 Operation	C 1-4 End of life	D Other environmental information
A1 Raw material A2 Transport A3 Manufacture	A4 Transport A5 Foundation and erection plus installations on site	B1 Use B2 Care and maintenance B3 Repairs B4 Replacement B5 Renovation and retrofitting B6 Energy B7 Water	C1 Demolition C2 Transport C3 Waste management C4 Final processing	Pros and cons outside the system parameters, e.g. environmental certification, energy recovery from wood.
Upstream	Central	Downstream		
Detailed information if possible, otherwise from construction database.	Detailed information about manufacture of carcass, transport to and on construction site, energy use and waste when constructing the building.	B1 – B5 as per appendix with standard times for maintenance and repairs. Energy use from energy calculation C1–C4, scenario for waste management using current methods.		Report any environmental information or other relevant information about the project.

Source: Tyréns AB

The positive properties of wood

Wood is a natural and renewable material that is produced locally for minimum transport needs. The by-products from production are used to generate energy, and the production process creates minimal waste. The material stores carbon dioxide throughout its lifetime, and at the end of its life it can be used as biofuel to replace fossil fuels.

It is possible, for example, to create a lightweight extension on existing foundations, which saves materials, and this is reported in module A. With lightweight movable walls, a retrofit can be completed without any major impact, and this is reported in module B5. And if you can reuse beams or structural elements, that brings considerable savings and can be reported in module D.



Spruce forest.

Figure 1.3 presents figures for some of these alternatives with regard to their impact on greenhouse gases in the atmosphere, expressed as carbon dioxide equivalents, in the production phase, from raw material extraction all the way to the finished product or component from the factory.

The results show a difference between the three wood building options, albeit a relatively small one. The emissions are somewhat higher for buildings designed to current standards, which is probably due mainly to the quantity of insulation used in walls and under the foundation slab, plus the use of more plastic-based materials. The difference between the standard design and the passive house design for the modern alternatives is mainly attributable to an increased amount of insulation.

The building with a concrete frame uses concrete, cast on site, for the foundation slab, the floor structure and the load-bearing walls, which explains the significantly higher carbon emissions, while emissions from mineral wool, plasterboard and wood materials are lower than for the wood-based options. The difference in emissions is in the order of 100 kg/m². Translating that to an apartment of 100 m², the difference is around 10 tonnes of carbon dioxide, CO₂, or around the same amount as a new car emits from 80,000 – 100,000 km of driving.

A CLT building differs from buildings using traditional concrete and steel techniques, since the wood material contains a large quantity of carbon compounds, which are stored for the entire life of the building. Figure 1.4 on page 15 shows the calculation of emissions for the other life cycle phases too, as well as emissions from energy consumption for heating and hot water over 100 years of the building's operation.

Carbon emissions (kg CO_{2,eq}/m² housing development)

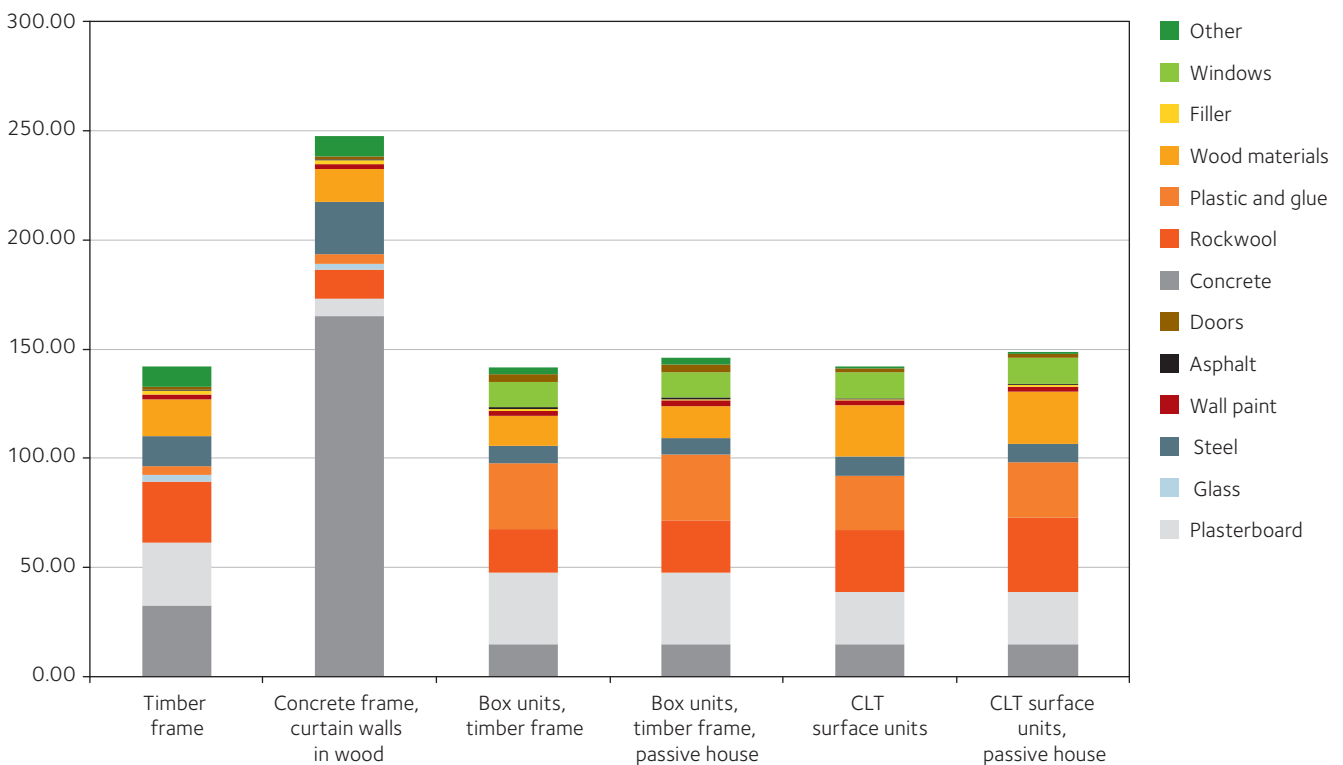

Figure 1.3 Greenhouse gas emissions (carbon dioxide equivalents, CO_{2,eq}) from the production phase for six different designs of a four-storey building. Standard means a building insulated to Boverket's Building Regulations (BBR) 2012 and passive house means a building insulated according to the passive house standard issued by the Forum for Energy-efficient Buildings (FEBY).

The concrete alternative also stores large quantities of carbon in the constituent wood material, for example in the wooden structure of the curtain walls, fixtures and interior wood surfaces. Another factor to bear in mind is that, at the demolition stage, the wood material can be used as energy. In *figure 1.4* shows the amount of emissions that can be avoided if one assumes that the wood material replaces coal in energy production.

The bar chart, see *figure 1.4*, also indicates major differences between buildings that meet the passive house standard and “normal” buildings. The parameters that are assumed to be different are amount of insulation, better airtightness and more low-energy installations. The carbon emissions calculations assume that the district heating system is based largely on bioenergy. In this scenario, emissions from 100 years of operation are the same size as in the production phase for passive houses and around two to three times the size for the other buildings. The calculation also considers the difference that arises from differing thermal inertia for the various structural frames, but with all of them having the same U-value in the building envelope and otherwise being assumed to be the same, the difference is marginal for residential buildings. Finally, the absorption of carbon dioxide during the building’s operational phase through carbonation of the concrete is also included.

A crucial factor for a building’s environmental impact is the service life of the building and its constituent parts. In this case, the assumption has been that there is no difference between the different alternatives with regard to service life or intervals for renovation, maintenance and replacement of materials and components. The judgement has been made that the overall differences lie in the structural frame, which is not expected to require any maintenance over the life of the building, while all exterior and interior surface layers have been assumed to be the same for each alternative.



Älvsbacka Strand, Skellefteå, Sweden.

Carbon emissions (kg CO₂_{eq}/m² housing development)

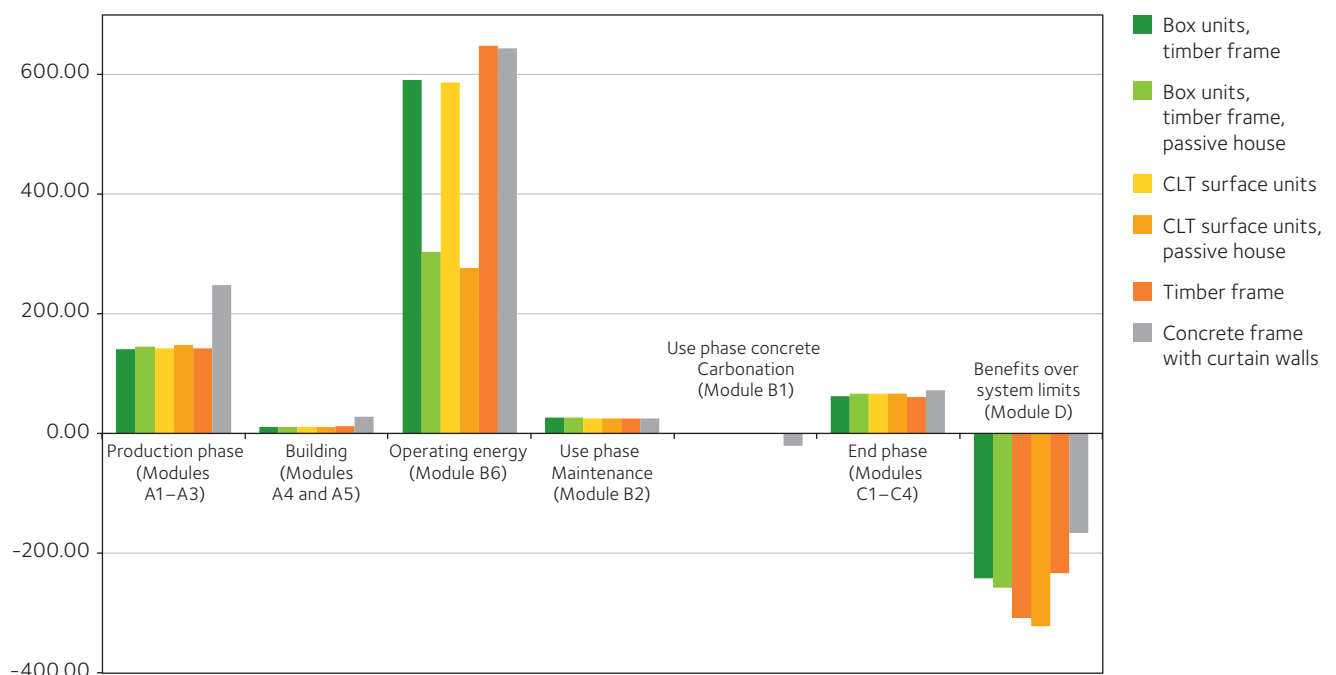

Figure 1.4 Greenhouse gas emissions (carbon dioxide equivalents, CO₂_{eq}) from the building’s life cycle for six different designs of a four-storey building. The two end columns represent alternative scenarios regarding end use of the wood material. Standard means a building insulated to Boverket’s Building Regulations (BBR) 2012 and passive house means a building insulated according to the passive house standard issued by the Forum for Energy-efficient Buildings (FEBY). For a clarification of the modules, see *table 1.1, page 13*.

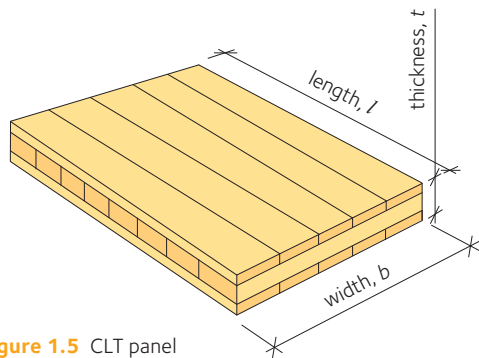

Figure 1.5 CLT panel

1.5 CLT manufacture

CLT is a construction material comprising at least three layers of glued boards or planks made from coniferous or deciduous wood, with each layer placed at 90 degrees to the next. CLT is manufactured to standard SS-EN 16351 and has to comply with the product properties that the CLT manufacturer has declared in its European Technical Approval, ETA.

Table 1.2 Common strength classes and dimensions of boards and planks used to manufacture CLT.

Parameter	Commonplace	Available
Thickness, t	20 – 45 mm	20 – 60 mm
Width, b	80 – 200 mm	40 – 300 mm
Strength class	C14 – C30	–
Width to thickness ratio	4:1	–

Table 1.3 Common dimensions for CLT panels. *Parameters see also figure 1.5.*

Parameter	Commonplace	Available
Thickness, t	80 – 300 mm	60 – 500 mm
Width, w	1,20 – 3,00 m	up to 4.80 m
Length, l	16 m	up to 30 m
No. of layers	3, 5, 7, 9	up to 25



CLT panels ready for packaging and delivery.

CLT panels are made up of boards or planks with a thickness of 20 – 60 mm. These boards and planks also go by the name of laminates or lamellae, but the CLT Handbook will continue to use the general term board. The raw material is timber that has been strength graded to standard SS-EN 14081-1. Each CLT manufacturer has their own standard thicknesses and strength classes. Similarly, the cross-section and the orientation of the layers differ from manufacturer to manufacturer. In Sweden, spruce and pine are the usual wood choices, but others may be used. The timber tends to be delivered dried and strength graded direct from the sawmill.

The moisture content in the boards must be between 8 % and 15 % when they are glued together, with the precise level determined by the glue being used and the end use of the product. The moisture content must not vary by more than around 5 % between adjacent boards. The strength of the bond is best when the moisture content is close to the equilibrium value in the finished structure, which also minimises any splitting in the wood. A certain amount of splitting is unavoidable in wood and it generally has no harmful effect on the performance of the structure.

The cross-section of CLT usually comprises boards of the same strength class in the main direction of the load. To make best use of the timber's strength, wood of higher strength is commonly used in the surface layer of the cross-section and in the main direction of the load, where the stresses are normally greatest. During manufacture, it is therefore necessary to have the space to store boards of at least two different strength classes at the same time.

The manufacture of CLT uses more or less the same process, see figure 1.6, page 17, no matter where it is made or by whom.

Firstly, the individual boards are finger-jointed to create long boards. Once the glue in the finger joints has hardened, the flat sides of the boards are planed and then immediately sent for gluing into sheets. The batches of boards are transferred to the gluing line and assembled into large sheets, which are pressed together under the necessary pressure. The glue then needs to harden for a set time, which depends on the type of glue and the temperature and moisture conditions in the gluing hall. The compression uses two main methods: vacuum and hydraulic. Vacuum compression provides a steady pressure, even on non-level surfaces, but the pressure is low.

Hydraulic compression may involve cold or hot pressing. After the gluing comes the final finishing of the components in a CNC machine, which may involve sawing edges, milling channels for installations, drilling holes and preparing for joints and fixings. The visible surfaces of each panel are polished, and finally the components are checked visually and labelled before they are packaged and loaded up for transport to a construction site or warehouse.



Finishing a CLT panel in a CNC machine, CNC = Computer Numerical Control.

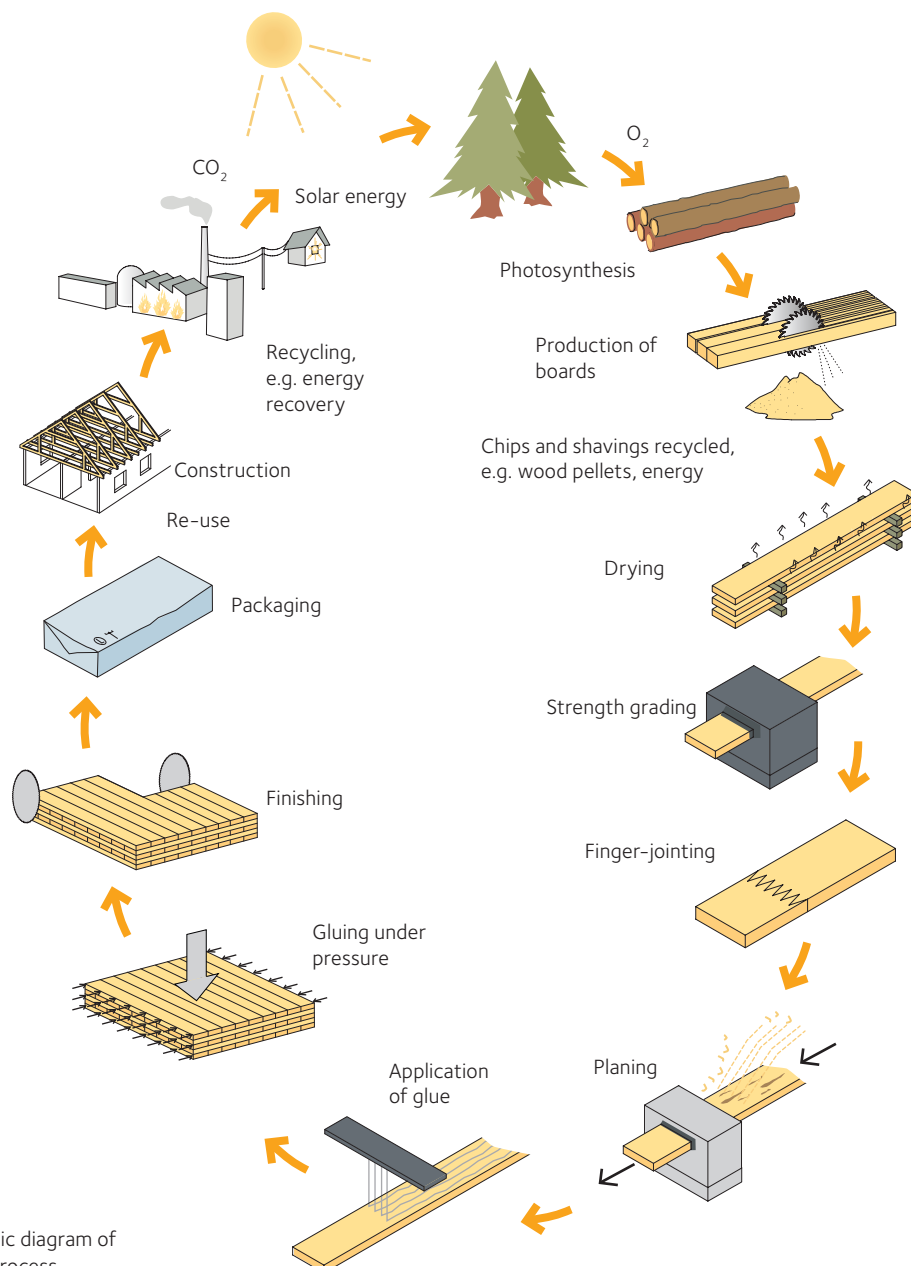
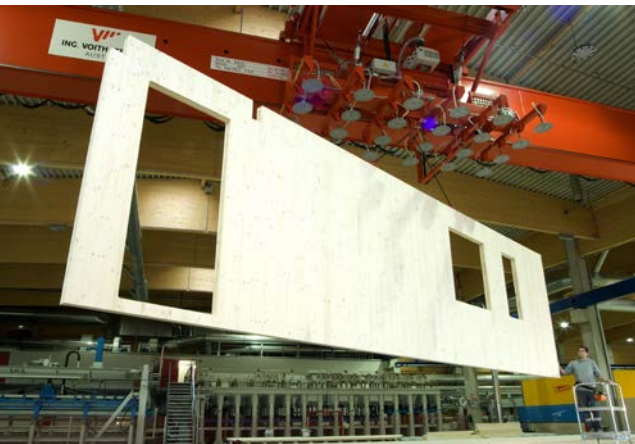

Figure 1.6 Schematic diagram of the CLT production process.



Manufacturing of CLT-wall.



The CE mark is used in various product areas.

1.5.1 Certified CLT

Suppliers of construction products must be able to verify the properties that they claim apply to their products, so that buyers can be confident that the products are compliant. To ensure this, an increasing number of construction products are now certified. As a result of European standardisation, the certification process is the same in all European countries.

Certified CLT is CLT that has been manufactured under controlled conditions and whose properties have been verified. The finger-jointing technique allows for the manufacture of very large panels, with the size and length limited firstly by the transport options and secondly by the CLT manufacturer's premises and equipment. Manufacturing CLT requires considerable precision, not least regarding the milling of the finger joints, glue preparation and application, pressure and timing. For CLT, gluing is usually the critical factor in ensuring the requisite quality and strength. The quality of the glued finger joints and layers is therefore constantly monitored through internal checks. In-house controls take place on a rolling basis to ensure that the products maintain consistent, high quality, and this involves taking regular samples to check for strength and delamination. These internal controls are verified by an approved third-party organisation.

An accredited control body issues certification, checks and verifies the company's internal controls and makes unannounced inspection visits to manufacturers.

The CE mark is a product label within the EU. A product that carries the CE mark may be sold in the European Economic Area (EEA — the 28 EU countries plus Norway, Iceland and Liechtenstein) without any additional documentation. The CE mark on a product shows that the manufacturer has complied with the basic requirements set out in the EU directives that govern this area. The precondition for compulsory CE marking is the existence of a harmonised standard. Work is currently underway (2017) to create a harmonised standard for CLT. This means that for CE marked panels of CLT for construction purposes, the properties must be specified and verified in line with, for example, the requirements in standard SS-EN 16351 Timber structures — Cross laminated timber - Requirements.

The standard states which documents are required for verification. To prove that CLT products meet the requirements in SS-EN 16351, they must be accompanied by a performance declaration. *See also the section on References, page 183.*

CLT panels have been in use since the 1990s, despite the lack of a harmonised standard. Since the standard is still new and has not become harmonised, there are several companies that have certified their products in accordance with the European Technical Assessment (ETA). An ETA is like a harmonised standard in that it contains instructions on verification procedures, for example for certification, type approval and control of manufacturing.

1.6 Properties

1.6.1 Strength properties

CLT displays major similarities with other wood products in terms of its strength properties:

- The strength varies according to the angle between the stress and the fibre direction, making it an orthotropic material.
- The strength falls as the moisture content rises.
- The strength falls as the length of time under load rises.
- The material properties vary both within one component and between different components.

The structure of CLT, with its perpendicular layered boards, evens out the variations in the wood and reduces the property differences. The strength of a CLT product is determined to a large extent by the composition of the cross-section. As with other structural components in wood and in a construction context, stiffness is often a design value. For CLT, the tensile strength of the surface boards and the rolling shear strength of the transverse layers are crucial in the breaking phase. In the use phase, the composition of the cross-section is an even greater determinant of what results can be achieved. In comparison with wooden decks such as stress-laminated timber decks, which are often used in bridge designs, CLT exhibits lower stiffness in the main direction of load for panels of the same thickness. A CLT panel can, however, take substantially higher loads across the main direction of load.

The basis for the static design of CLT and wooden structures in general is a characteristic strength or stiffness value, determined via testing under laboratory conditions and via a set number of samples. Normally, strength calculations in a design are based on the lower 5 % fractile, which is the value that is statistically undershot in 5 cases out of 100. Knowing the characteristic strength value, the design value for the individual case is then determined using various partial coefficients and conversion factors. Characteristic stiffness values such as modulus of elasticity and shear modulus are determined in a similar way, but taking the average value as the starting point, rather than the 5 % fractile.

1.6.2 Thermal properties

Wood has very small temperature movements, compared with many other materials. The thermal conductivity and thermal capacity of CLT is practically the same as for solid wood. The thermal conductivity, which describes the material's insulating capacity, is significantly better than for concrete and steel. The practical value for thermal conductivity for spruce is 0.11 W/(m °C) at a right-angle to the fibres and 0.24 W/(m °C) parallel with the fibres, while for pine the equivalent values are 0.12 W/(m °C) and 0.26 W/(m °C), respectively. In practice, a value of 0.12 – 0.13 W/(m °C) tends to be used for CLT. CLT has a relatively high specific thermal capacity, which is usually stated as around 1600 J/(kg °C). When building with CLT panels, the large quantity of wood influences the indoor climate by levelling out climate variations. The scale of this effect is determined by the other constituent materials, the ventilation system and the inbuilt regulation and control technology.



Testing of strength of CLT.

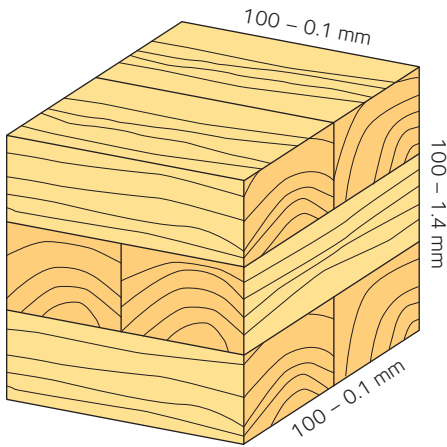

Figure 1.7 Approximate contraction and expansion of a CLT panel per 100 mm when drying from 20 % to 10 % moisture content.

1.6.3 Moisture-related movement

CLT expands when the moisture content increases and contracts when the moisture content falls. The alternating layers of boards mean, however, that the wood in CLT panels expands and contracts less across the fibre direction than ordinary solid wood does. CLT is manufactured under controlled conditions from boards and planks with a moisture content of between 6 % and 15 %. The question of how much less the expansion and contraction will be compared with ordinary solid wood is determined by the number and thickness of the layers. Products made from CLT are usually manufactured with a target moisture content of 12 %. This means that individual CLT products are to have a moisture content of no more than 16 % on delivery. The moisture content of CLT will gradually achieve equilibrium with the ambient relative humidity (RH) and follow its variation over the year. Depending on where the building is located, which part in the construction, heated or cold building, the moisture content will vary in the element between about 4 – 5 % over the year.

An uninsulated CLT panel or an insulated hollow core structure in CLT placed in a roof or outer wall will be subject to varying moisture conditions – warm and dry on the inside and cold and damp on the outside – which means that the component may tend to expand on the outside and contract on the inside, taking on a bowed shape. This is a peculiarity that the structural engineer should bear in mind at the planning stage.

1.6.4 Fire properties

CLT and structures made from CLT have good, predictable properties when it comes to fire. CLT is a flammable material, but in combination with other materials, the required load-bearing capacity can be maintained during the fire. Wood is slow to catch fire and it burns slowly. The way the heat develops during a fire is often crucial in determining whether the fire will spread or burn out. The charcoal layer that forms on the surface of CLT in a fire protects the inner parts, and the penetration rate for wood is generally around 0.6 – 1.1 mm per minute. You can read more about how to design for fire, load factors and how further fire protection can be achieved with supplementary layers in *chapter 7, CLT and fire, page 133*.

1.6.5 Classes and surface treatment

CLT panels are primarily considered structural components whose key properties are strength, stiffness and durability. Standard products meet normal appearance requirements, as long as they are handled with sufficient care in transit and on the construction site.

When the CLT panels are taken out of the glue press, they have minor irregularities along the sides, which are duly removed. The smooth surface is usually of sufficient quality and further finishing is not required.

If the design specifies exposed surfaces, boards should be chosen based on the requirements placed on the surfaces. Most CLT manufacturers have a few different appearance classes to choose from and different ways of naming these, such as Exposed surface, Industrial surface and Non-exposed surface. CLT panels can then be surface treated on site just like ordinary wood, using woodstains, paints, varnishes or oils. *Table 1.4, page 21*, show examples of what may occur and what is not permitted for different appearance classes.

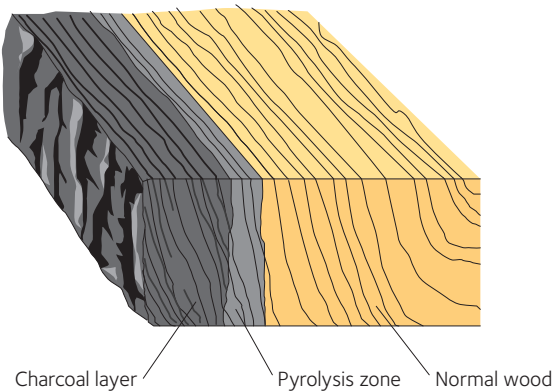





Figure 1.8 Fire penetration

Table 1.4 Appearance classes, example

Appearance class	May occur	Not permitted	Example of surface
Exposed surface	Few pitch pockets under $3 \times 40 \text{ mm}^2$ Black knot less than 10 mm Sound knot less than 10 mm	Enclosed bark, open scars, firm/soft rot, pith, insect attack, wane, knot hole, decayed knot, encased knot, notches, splits (not seasoning checks), visible glue	
Industrial surface	Few pitch pockets under $3 \times 40 \text{ mm}^2$ Black knot less than 20 mm Dead knot less than 20 mm Sound knot, pith, knot hole, minor occurrence of notches, visible glue	Bark-encased scars, open scars, firm/soft rot, insect attack, wane, decayed knot, encased knot, splits (not seasoning checks), eye-catching knot clusters	
Not exposed surface	Pitch pockets, knot holes, black knots, decayed knots, dead knots, notches, encased knots, sound knots, pith, splits, insect attack, visible glue, colour differences between boards, blue stain to a lesser extent.	Firm rot, soft rot	

1.7 Where can you use CLT?

Wood is an eco-friendly and recyclable construction material that, used correctly, has a long service life. It can be reused in new structures or incinerated for energy recovery. Wood is light in relation to its strength, as well as being easy to handle and work with. Wood has a good capacity for thermal insulation and thermal storage. Structural components made from CLT are used primarily for walls and floor structures, but CLT panels may be used for a wide range of different applications, from small to large scale.

The characteristic feature of structural components in CLT — for walls and floor structures — is their size. Large cross-sectional areas ensure that CLT components have a high load-bearing capacity and stiffness, making them suitable for stabilising the building. The panels are available with a high degree of prefabrication and their low weight brings benefits in terms of groundwork, transport and assembly. Making holes and attaching fixings is simple and straightforward. The insulation layer in an outer wall runs all the way through, with no thermal bridges. The solid structure and the cladding material usually used provide good fire safety. CLT frames are light in comparison with frames made of concrete, for example. To achieve good sound insulation in floors and walls, multilayered structures therefore must be used.

Apartment balconies, access balconies and mezzanine floors, not to mention lift shafts and stairwells, are other areas where CLT is used to great effect. CLT slabs for these applications provide a host of benefits compared with building using either concrete components or a regular timber frame. Their low weight makes these wooden slabs or panels significantly easier to handle than the equivalent concrete. Fixings and groundwork are also made easier, which is of benefit when redeveloping existing buildings. Mezzanine floors made from CLT are often a good choice, as they allow older industrial buildings with high ceilings to be divided up into several storeys.



Example of compact living, Virserum, Sweden.



6-storey apartment block, Fristad, Sweden.

1.7 Where can you use CLT?



Balconies made of CLT, Inre Hamnen, Sundsvall, Sweden.

Due to the low weight of CLT, reconstruction can often be carried out without reinforcing the foundations. Another advantage of the low weight is transport and lifting during construction. A CLT frame is also a good option for densification projects and vertical extensions to existing buildings for the same reason, and because CLT can handle large spans.

Wood is sometimes the only sustainable alternative in certain contexts, such as buildings where the material is exposed to an aggressive environment or where the mechanical wear is too much for other materials, which would only last a short time or no time at all.

Multi-storey car parks can be appropriately designed around a load-bearing structure comprising posts and beams of glulam, with floor slabs and ramps made from load-bearing CLT. A 17 m wide parking deck, comprising two rows of parking spaces separated by a driving lane, can be formed from solid CLT slabs or slabs reinforced on the underside with glulam beams.

To prevent flames from spreading along the ceiling, the wooden surface can be protected on the underside with fireproofing paint, for example. Alternatively, wood wool panels can be an alternative. Beams or screens angled downwards can also slow the spread of fire and smoke along the ceiling.

CLT offers infinite possibilities, limited only by the designer's imagination. Everything from the boards around an indoor riding arena to large stairwells or ventilation towers are examples where CLT panels are the ideal, and sometimes only reasonable, choice.

CLT panels have the specific ability to combine load-bearing capacity and screening, which means that the product can be used for balustrades and screens in environments where the surface material is subject to major mechanical wear.



Example of a roof structure with load-bearing and stabilising CLT panels, which also contribute to a good indoor climate.



Car park with load-bearing CLT slabs, Skellefteå, Sweden.



Indoor riding arena with walls and boards in CLT, Sätra, Sweden.

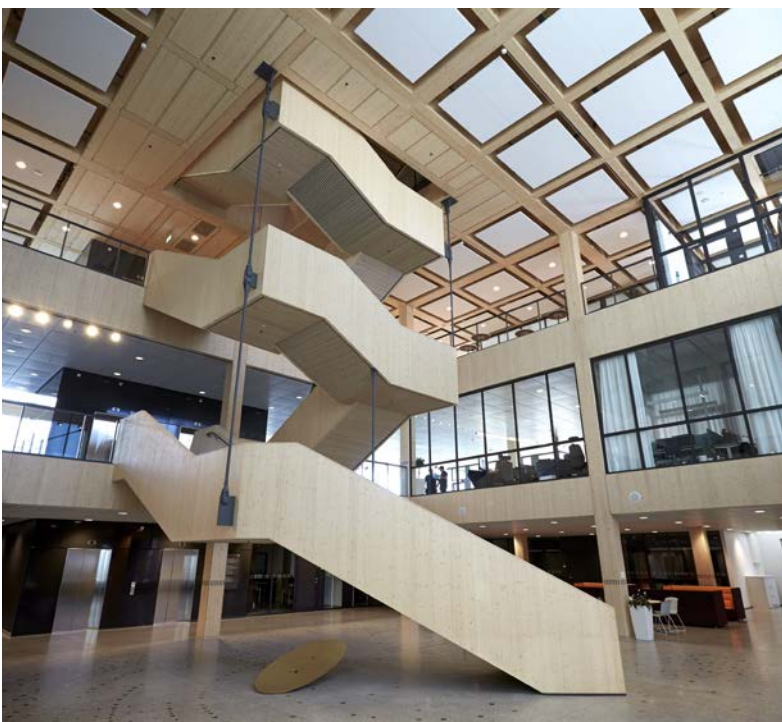

Ulls Hus, Uppsala, Sweden.



Stepped ledges provide standing room or seating, forming stands in sports venues and halls, Järfälla, Sweden.

Design systems for CLT

- 2.1 Floor structures and walls 25
- 2.2 CLT as a beam 26
- 2.3 CLT in shell structures 26
- 2.4 Initial design 27
 - 2.4.1 Floor structures 27
 - 2.4.2 Walls 28

CLT panels allow for a new way of building with wood. This chapter presents a few basic CLT structures – from basic systems using panels on two supports to shell structures, all of which exploit the unique opportunities of CLT in different ways and to varying degrees. The choice of structural system is influenced primarily by the building’s design, function and budget. Limitations in terms of production or transport can also be determining factors in some cases.

When planning structures in CLT, there are a few recommendations that should be kept in mind:

- CLT should be seen as an orthotropic panel with three mutually perpendicular planes of symmetry, with different properties in each direction.
- CLT can be subjected to forces perpendicular to the source, as well as axial forces (compression and tensile forces in parallel with the surface), *see figure 2.1 and figure 2.2.*
- Tension perpendicular to the fibre direction caused by loads or shrinkage should be avoided.
- For short lengths, the shear forces in the transverse layer are often critical.
- Eccentricity and torsion should be avoided.
- Three-dimensional construction systems are often optimum in terms of stability and safety.

CLT panels with a load perpendicular to the surface can be designed and executed as panels with one or two main load-bearing directions. The distribution of forces is determined by the thickness and strength of the boards. The most common approach is to have the strongest load-bearing direction parallel with the boards in the outer layer. It is easiest to apply regular beam theory and design a CLT panel with a load perpendicular to the panel as a simply supported panel on two or more supports. With short spans, the impact of the shear deformation on the total deflection increases and should be taken into account in the design.



Trussed CLT roof, Flyinge Riding School, Lund, Sweden.

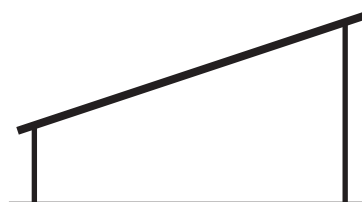

Figure 2.1 Design principle with self-supporting roof CLT-panels.

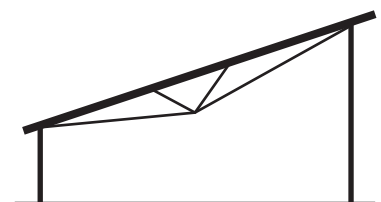

Figure 2.2 Design principle with trussed roof CLT-panels.

2.1 Floor structures and walls

CLT as a floor structure must take vertical loads such as imposed load and self-weight and transfer them to the supports. The floor panel can also handle horizontal loads such as wind load. In its most common form, a CLT structure are panels placed on two supports.

The supports may run along the whole length of the panel or be point supports at set intervals. For floor structures or similar structures with relatively small spans, panels of an even thickness are preferable, but there may be economic grounds to reinforce the panels with glulam beams, for example, to create a T-cross-section. Deflection or vibrations is often critical design factor for floor structures.

CLT panels can be load-bearing in one or more directions. If it is load-bearing in one direction, it can be designed as a simply supported panel strip. If it is designed to have two load-bearing directions, it can be considered as a three or four-sided supported panel.

Although the load-bearing boards in the main direction of the load have the greatest effect on the panel's properties, account must be taken of transverse layers in deformation and tension calculations. Rolling shear fractures can occur in CLT when the wood fibres roll or slide between each other under shear stress across the fibres, and this results in greater shear deformations and lower shear force capacity. Geometry and manufacture are therefore of major importance, and boards with no edge glueing or tongue and groove and with a width to thickness ratio of less than four are considered to have bigger risk for shear failures.

Composite floor structures in wood and concrete, *see figure 2.3*, have been in use for a long time. The principal for these floor structures is that the compression forces are absorbed by the top concrete slab and most of the tensile forces are absorbed by the underlying wooden structure. This places major demands on the way the wood and concrete are joined together. If wood and concrete are completely bonded to each other, the cross-section only has one neutral axle and the strain will be constant across the whole cross-section. However, if no shear forces are transferred between the wood and the concrete, the floor structure is considered to comprise of two individual parts.

Installations are a vital part of a building, and in many cases they affect the design of the load-bearing components. When large holes are made in timber structures, some form of reinforcement is often required in order to lead forces past the installation holes. CLT panels have the advantage that even with large holes, they can often distribute and transfer the forces to the adjacent structures without the need for extra reinforcement.

Wall panels in CLT generally have a good load-bearing capacity. The vertical load in a wall panel can be seen as a linear load and panels with a thickness of 80 mm can be designed to take loads of over 100 kN/m. If possible, an intermediate floor structure that uses a wall for support should be centred as well as possible in order to avoid or minimise any moment of eccentricity. It is, however, uncommon for the vertical load to be entirely centric, so this should be taken into account when designing wall panels. For wall panels with large window openings, it should be noted that the panels between the windows should be treated as columns with a buckling length equivalent to the height of the storey.

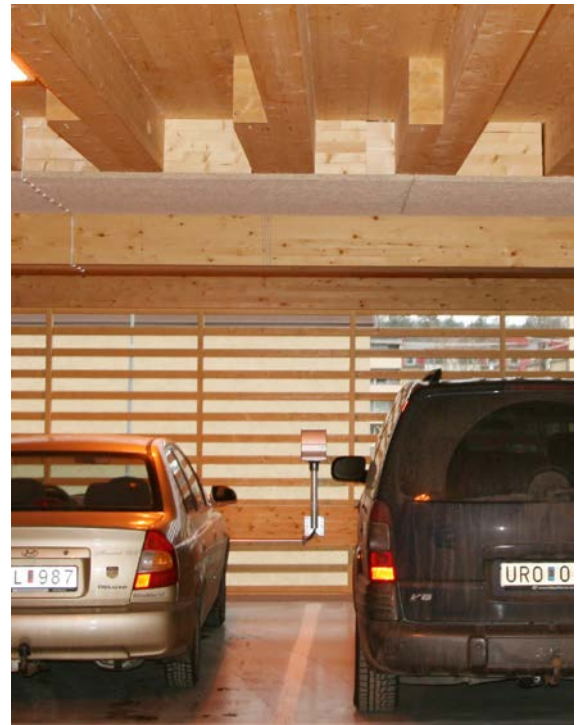

CLT panels combined with glulam beams. Intermediate floor structure in car park, Skellefteå, Sweden.



Example of holes cut in CLT. The structure of the panels provides wide scope for architectural design flourishes and adaptation to the client's wishes and requirements.

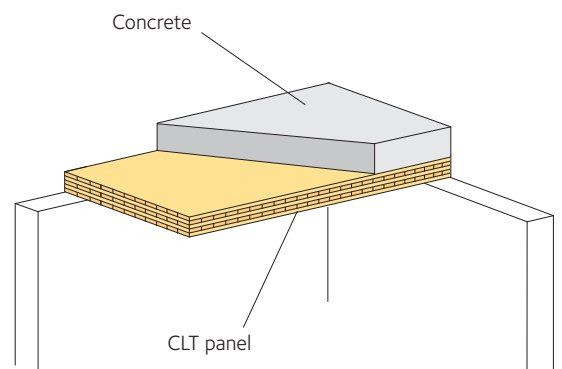

Figure 2.3 Composite floor structure.

2.2 CLT as a beam



CLT panel acting as an integral lintel above a door opening, Hyttkammaren, Falun, Sweden.

CLT can be used as a beam to support floors or roofs of CLT. The beams require bracing, which can be achieved by screwing the floor or roof panel firmly into the beam. Beams can also be used to stiffen floor, roof or wall panels. CLT beams can usefully be made with increased dimensions and/or strength in the layer that runs longitudinally as this carries the load, while the intermediate layers largely provide dimensional stability. Another advantage of CLT panels is the integral door and window lintels that are gained automatically when the openings are cut out of the CLT-panels. In most cases these will have sufficient load-bearing capacity and further reinforcement will generally not be required.

2.3 CLT as a shell structure



Music pavilion, Fristad, Sweden.

CLT offers huge opportunities to use different types of shell structures for advanced designs and large, post-free spaces. Depending on the manufacturing procedure, curved and bent components can be produced to some extent. To date, CLT panels have only been used for shell structures to a limited extent, but a number of projects have been completed. Such shell components, which are largely subject to normal forces or bending, are used primarily for special roof structures.

Combining several shell components of the same type can create many different roof shapes. Relatively common shell designs include conoid and hyperbolic paraboloid (HP-shell). A valuable property of these two is that they can be created using straight lines and they can therefore easily be built up from one or more intersecting layers of boards.

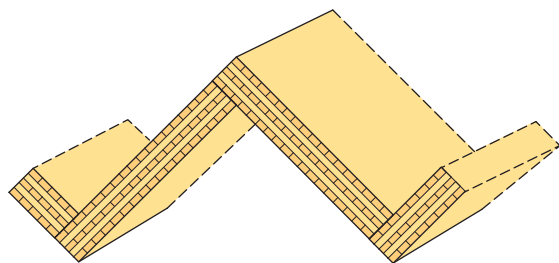

Figure 2.4 CLT that serves multiple functions: load-bearing, stabilising and enclosure.

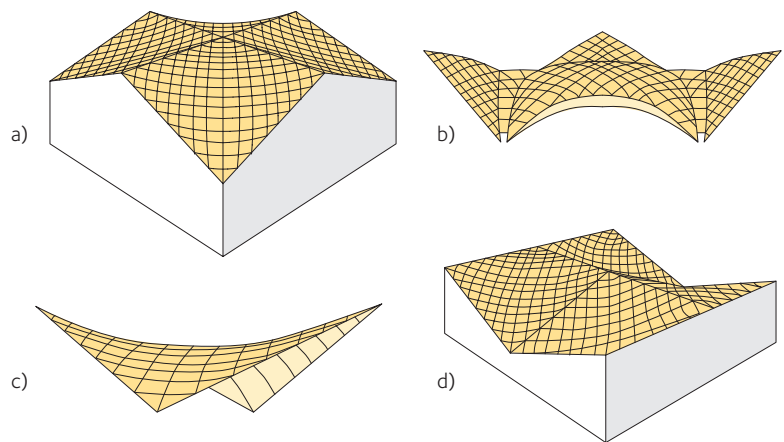

Figure 2.5 Examples of shell structures.

- a) Hyperbolic paraboloid (HP) shell
- b) Shells that intersect each other
- c) Hyperbolic paraboloid
- d) Hyperbolic paraboloid

2.4 Initial design

This part of the CLT Handbook gives a short overview of the dimensions that can be expected for a specific designed load. The diagrams below show approximate spans and permitted vertical loads for a few common types of floor structures and wall panels made from CLT. The values have been calculated on the basis of design standard Eurocode 5, including the national annex.

The diagrams in figures 2.6 – 2.9 are intended for use in determining initial design dimensions, for example in an early stage of planning, and do not offer a replacement for ultimate design at a later stage. For more accurate structural design, see chapter 3, page 30.

2.4.1 Floor structures

The diagram below shows the panel thickness for different spans. The figures in the diagram relate to service class 1 and are to be considered approximations, since the structure of the CLT panels and the strength grade affect the stiffness of the panels. For absolute accuracy, always contact the CLT manufacturer for the relevant strength and stiffness values.

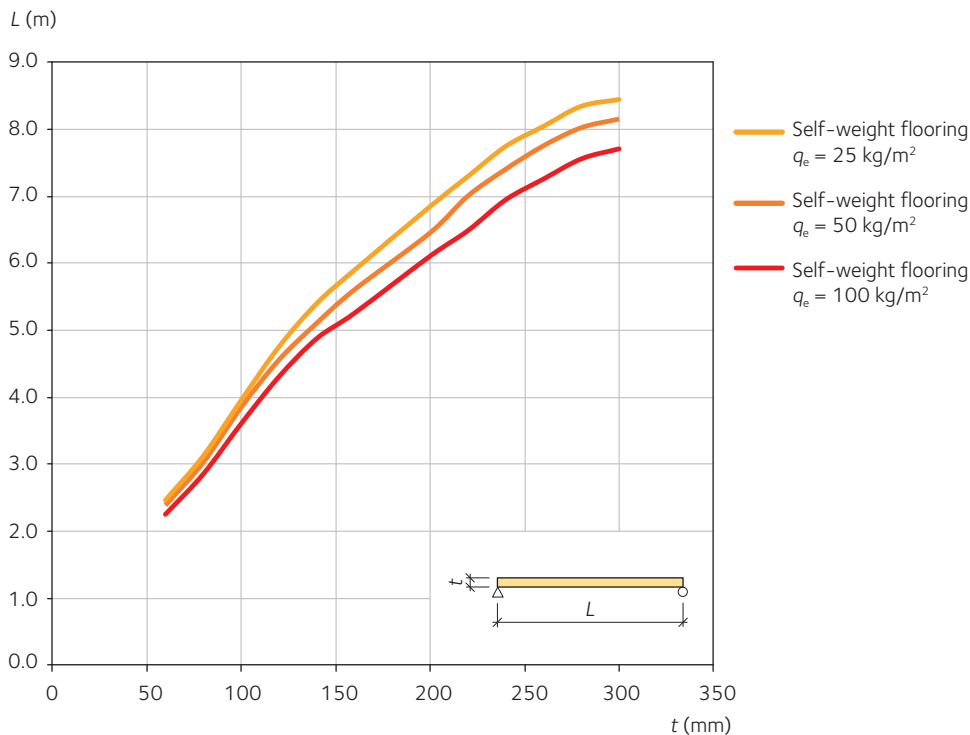

Figure 2.6 The figures are for a floor structure with a span of L and a thickness of t in service class 1, with a typical domestic load of 2.0 kN/m^2 . Deviation requirement $L/300$ and a deviation $< 20 \text{ mm}$ and fundamental frequency $> 8 \text{ Hz}$. The self-weight of the ceiling and flooring at a total of 25 , 50 and 100 kg/m^2 has been included. Since the serviceability limit is a design value, the diagram is independent of safety class. The case of fire load has not been taken into account.



Multi-storey building, Finland.

2.4.2 Walls

The diagrams show the permitted vertical load N_d per metre of length under different distributed loads q_d and for different wall heights l_e . The design values in the diagram are to be considered approximations, since the structure of the CLT panels and the strength grade affect the load-bearing capacity of the panels. In the case of high utilisation of the load-bearing capacity, always contact the CLT manufacturer for the relevant strength and stiffness values. The diagrams relate to safety class 3, service class 1 or 2 and a load duration class of medium term (M). The fire load factor has not been taken into account.

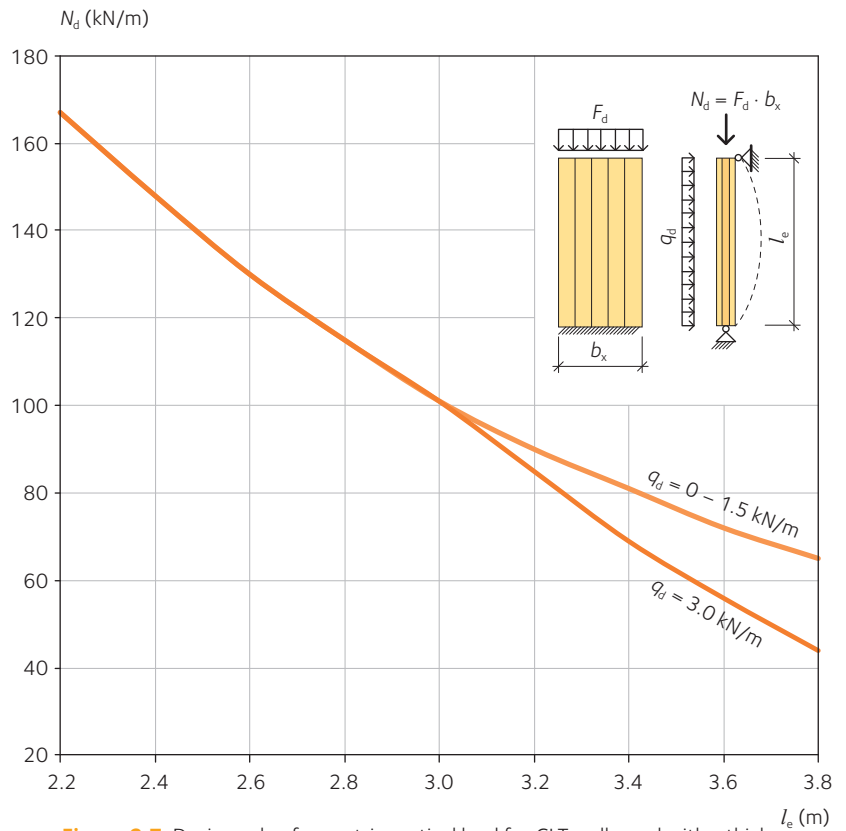

Figure 2.7 Design value for centric vertical load for CLT wall panel with a thickness of 80 millimetres designed for safety class 3, load duration class medium term (M) for vertical load and short term (S) for transverse load and service class 1 or 2.

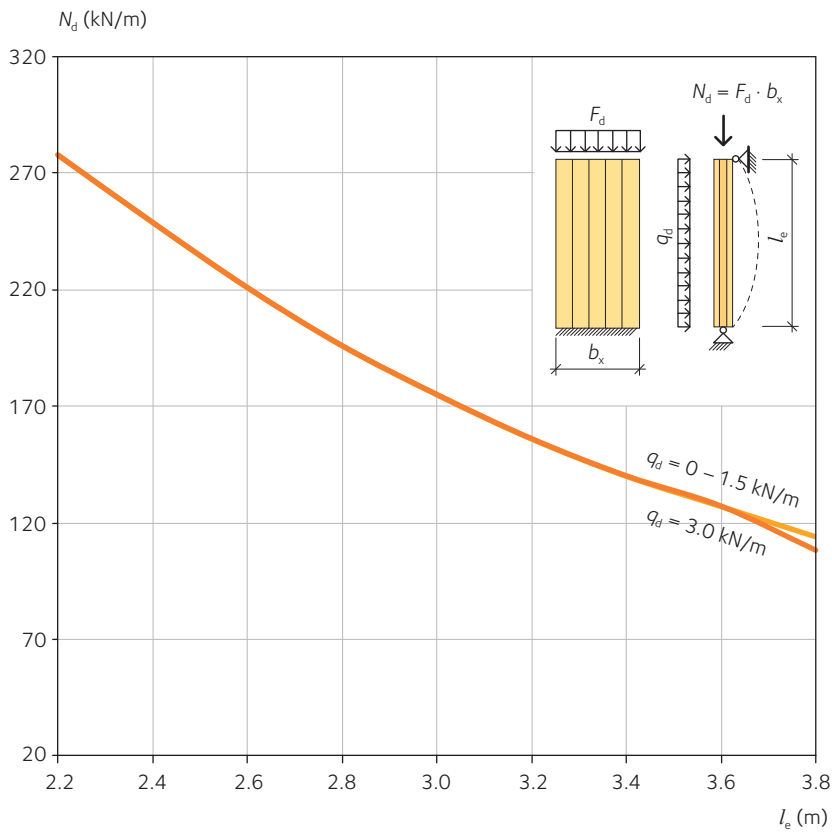

Figure 2.8 Design value for centric vertical load for CLT wall panel with a thickness of 100 millimetres designed for safety class 3, load duration class medium term (M) for vertical load and short term (S) for transverse load and service class 1 or 2.2.

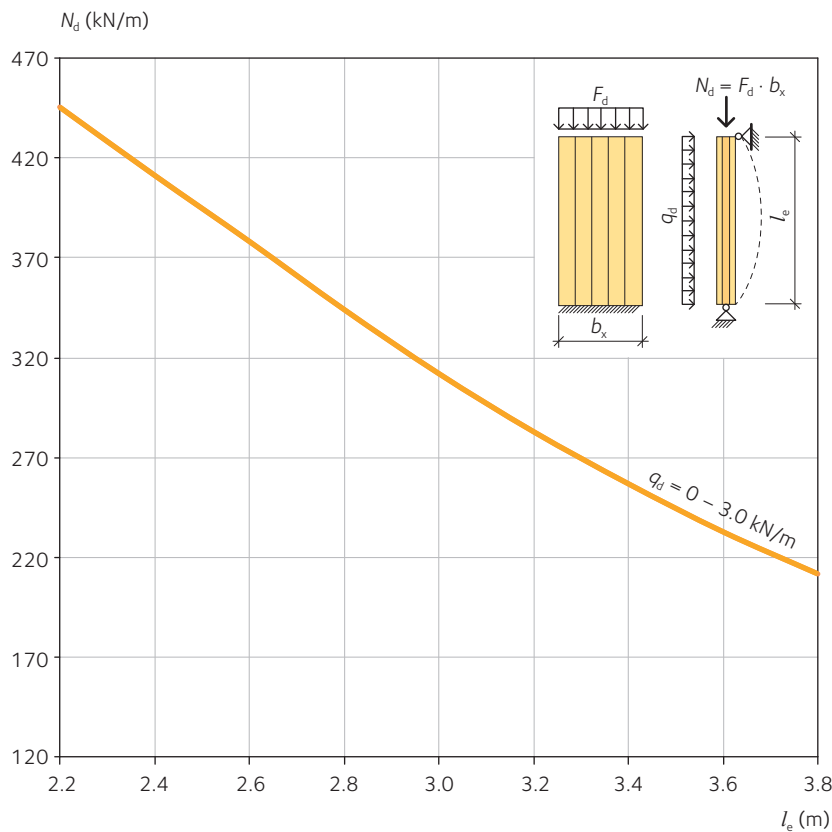

Figure 2.9 Design value for centric vertical load for CLT wall panel with a thickness of 120 millimetres designed for safety class 3, load duration class medium term (M) for vertical load and short term (S) for transverse load and service class 1 or 2.

Design of CLT structures

- 3.1 **Basis for design** 30
 - 3.1.1 Load effects 31
 - 3.1.2 Safety classes 32
 - 3.1.3 Load duration and service classes 33
 - 3.1.4 Design resistance and stiffness 34
 - 3.1.5 Partial factor and modification factors 35
 - 3.1.6 System effect 36
- 3.2 **Material properties of CLT** 37
- 3.3 **CLT design using beam theory** 40
 - 3.3.1 Definition of directions 40
 - 3.3.2 Cross-section quantities for 3-layer and 5-layer panels 45
 - 3.3.3 Non-symmetrical cross-section and layers with different modulus of elasticity 47
 - 3.3.4 Effective cross-section values 48
 - 3.3.5 Designing in the ultimate limit state 52
 - 3.3.6 Designing in the serviceability limit state 60
- 3.4 **CLT as two-dimensional load-bearing slabs or panel** 63
 - 3.4.1 Orthotropic slab with effective thicknesses 63
 - 3.4.2 Orthotropic shell with direct determination of stiffness matrix 64
- 3.5 **Design software for CLT** 67
- 3.6 **Examples** 68
 - 3.6.1 Cross-section properties and deflection for 5-layer symmetrical panel 68
 - 3.6.2 Cross-section properties and deflection for 5-layer non-symmetrical panel 70

The basic principle when designing structures using the partial factor method is to verify that the design value for load effect E_d for a specific structural component is less than the design value for the resistance R_d :

$$E_d \leq R_d$$

where:

E_d is the design value of the effect of actions such as internal force, moment or a vector representing several internal forces or moments.

R_d is the design value of the corresponding resistance.

3.1 Basis for design

Eurocodes have been used in Europe since 2010. New Eurocodes are expected to be in place by 2021 that will include the design of CLT. In the meantime, design methods will be refined and developed via bodies such as the European Committee for Standardization (CEN) and its working groups.

Designers of load-bearing structures in CLT can basically choose between two options for planning their designs – either design the cross-section based on the properties of the laminates in the CLT or use the tables of properties drawn up and published by the CLT manufacturers.

Since a structure's behaviour often differs during normal use and under loads close to failure, designs are created in the ultimate limit state and in the serviceability limit state. The limit state means the state in which a structure or part of a structure just meets the set requirements.

When designing in the ultimate limit state, the structure must have a comfortable margin against failure if it is used in the manner it was designed for. The prevailing building regulations determine what is considered a comfortable margin. When designing in the serviceability limit state, there are not usually any compulsory requirements in the standards. In most cases, recommendations are made, and it is left to the developer or their experts to decide what is acceptable.

The risk of achieving a certain limit state, for example a failure in the structure, depends on circumstantial uncertainties, such as:

- the probability of the assumed loads being exceeded.
- the probability of the load-bearing capacity is overestimated .

Normally, both the external effect of loads and the structure's load-bearing capacity can be seen as random variables. If you know the distribution functions for these variables, it is therefore possible

to calculate the failure risk with the help of probability theory methods. Knowledge of these distribution functions is, however, inadequate, particularly for the extremities, which are often crucial for the results.

In practice, this means using different standard functions, usually the normal distribution and the Weibull distribution. The failure risk calculated in this way becomes purely theoretical and the method is thus actually not useful for practical designing. Although probability theory methods may not be practical for designing in an individual case, they can be useful for comparisons, for example between different materials or between different design types. Probability theory methods are therefore of great importance as tools for calibrating other, simpler methods, such as the partial factor method.

Design rules for load-bearing buildings focus in the first instance on limiting the risk of a failure. In addition, there is a desire to ensure that the building works satisfactorily in normal use.

The building standards specify the acceptable verification methods, i.e. the methods for establishing compliance with the set requirements. The standards also state the conditions relating to loads, strength and so on that must form the basis for the design process.

Just like other construction materials, CLT structures are calculated and designed in line with prevailing standards. The Eurocodes and Boverket's EKS series of regulations form the Swedish rules for verification of structural resistance, serviceability and durability. The EKS regulations set out the nationally selected Swedish parameters for the application of the Eurocodes. The national options are based, for example, on varying national factors relating to geology, climate, lifestyle and safety levels. The standards are based on the partial factor method, which is the calculation method applied to load-bearing structures in most of countries in Europe. This method means that the structures are checked in two limit states – the ultimate limit state and the serviceability limit state. In the ultimate limit state, the structures are checked to ensure that they are sufficiently safe against failure. In the serviceability limit state, the structures are checked to ensure that they do not suffer deformations of such a scale that they fail to meet the performance levels required from the structures. Checks should also be focused on vibrations and resonance frequency in floor structures.

Designing in line with the Eurocodes assumes that:

- The structures are designed by qualified and experienced people.
- Factories, workshops and construction sites are subject to proper manufacturing controls.
- The materials and products are used as prescribed in the Eurocodes or in relevant material or product descriptions.
- The extent and intervals of building maintenance are appropriate for achieving the intended performance and service life.
- The building is used in accordance with the assumptions made in the design phase.

3.1.1 Load effects

Load effect refers to deformations, moment, shear force or any other cross-sectional force caused by a load. The design value for load effects is determined based on the design values for the loads in question, placed in the least favourable load positions.



Elefantenpark, Zürich, Switzerland.



Erection of walls made of CLT, Bromma Blocks, Stockholm, Sweden.

A structure is usually designed not for one load but for different load combinations. A leading action (with its full value) is combined with other potential interacting actions (with reduced values) to obtain a design load case.

Reduced loads are obtained by reducing the characteristic value Q by the factors ψ_0 , ψ_1 and ψ_2 which are described as follows:

- The combination value ($\psi_0 Q$) is used for verification in the ultimate limit state and for the characteristic combinations for an irreversible serviceability limit state (the consequences of the loads exceeding a certain serviceability limit continue once the loads have ceased to act).
- The frequent value ($\psi_1 Q$) is used for verification in the ultimate limit state for accidental loads and for a reversible serviceability limit state. The frequent value is exceeded around 1 percent of the time.
- The quasi-permanent value ($\psi_2 Q$) is used to estimate long term actions in the serviceability limit state, such as deflection or splitting, and to take account of variable loads in accidental combinations in the ultimate limit state. The quasi-permanent value equates to the average time of the variable load.

The factor ψ_2 can also be a factor that converts short term actions into equivalent permanent actions when designing for long term effects such as shrinkage. SS-EN 1990 defines combination rules for loads for different design situations, and EKS states the nationally adopted values for Sweden. The following general *equation 3.1* applies, for example, to the design of lasting or temporary design situations in the ultimate limit state:

$$3.1 \quad E_d = \sum_{j \geq 1} G_{k,j} \gamma_{G,j} + Q_{k,1} \gamma_{Q,1} + \sum_{i > 1} Q_{k,i} \psi_{0,i} \gamma_{Q,i}$$

where:

- $G_{k,j}$ is the characteristic value for the permanent action j .
- $\gamma_{G,j}$ is the partial factor for the permanent action j .
- $Q_{k,1}$ is the characteristic value for a variable leading action 1.
- $\gamma_{Q,1}$ is the partial factor relating to $Q_{k,1}$.
- $Q_{k,i}$ is the characteristic value for the interacting variable action i .
- $\psi_{0,i}$ is the reduction factor for the combination value for the variable action i .
- $\gamma_{Q,i}$ is the partial factor for the variable action i .

3.1.2 Safety classes

The risk that a structural failure will cause serious personal injury varies depending on what the building is used for and the function of the different components of the building. The risk of personal injury is greater, for example, if there is a bending failure in a roof beam than if there is a bending failure in a wall stud, and the risk is greater if the beam is holding up the roof of a sports hall than if it is in a timber warehouse.

In Sweden, these differences are considered by categorising load-bearing structures into different safety classes, depending on the consequences that a structural failure would have. The division into safety classes is part of the Swedish national annex to the Eurocodes.

When designing, using the partial factor method according to EKS in the ultimate limit state, the safety class for a building component is to be considered using the partial factor γ_d as shown in *table 3.1, page 33*.

In the serviceability limit state, however, no distinction is drawn between the safety classes.

Table 3.1 Partial factor for safety class, γ_d , when designing in the ultimate limit state.

Class	Scope	Partial factor, γ_d
Safety class 1	(low), little risk of serious personal injury	0.83
Safety class 2	(normal), some risk of serious personal injury	0.91
Safety class 3	(high), major risk of serious personal injury	1.0

3.1.3 Load duration and service classes

The stiffness and load-bearing capacity of a timber structure is dependent to a high degree on the duration of the loads that act on the structure. During the design process, a distinction is therefore made between loads of different duration, for example permanent actions such as self-weight, and actions with a variable intensity over the lifetime of the building, such as imposed load. The imposed load are normally divided into long-, medium- and short term actions. Sometimes accidental actions also occur, such as impacts. The building regulations state modification factors for the strength and stiffness values, with reference to the load duration class.

Resistance is calculated based on the material values applicable to the action in a combination of actions that has the shortest duration. Deflection is calculated as the sum of the deflection contributions from the constituent actions – each calculated regarding the duration of the individual load.

The duration class or action type to which a load should be assigned depends to a certain extent on geographic, climatic and cultural conditions. Snow load is, for example, considered a long term or medium-term action in Sweden, Norway and Finland, while Denmark and much of the rest of Europe treat snow load as a short term action.

Like the load duration, the moisture content of the wood has a major impact on the material's strength and stiffness. Dry wood is both stronger and stiffer than damp wood. The building regulations handle this by defining several service classes, each defined by a particular moisture content interval within the range that is typical for buildings. The building regulations state modification factors for the strength and stiffness values, with reference to the load duration class. The final moisture content of the wood in a structure is determined by its surroundings, temperature and relative humidity (RH), which will also vary over the service life of the structure, *see figure 3.1*.

It is the structural engineer's task, based on the conditions in the individual case, to determine which service class a structural component should be assigned to. The CLT Handbook provides guidance by giving examples for common components.

Service class 1 is characterised by an environment where the relative humidity (RH) exceeds 65 % for only a few weeks per year. This equates to an average moisture content in the CLT that only exceeds 12 % for short periods.

Components in this class include:

- Ceiling joists and roof structures in cold but ventilated loft spaces above regularly heated premises.
- Wall panels in external walls in regularly heated buildings, if they are protected by ventilated and drained cladding.
- Floor structures over crawlspace ventilated with indoor air.
- Frames in well-ventilated indoor pools, ice rinks and insulated riding arenas.

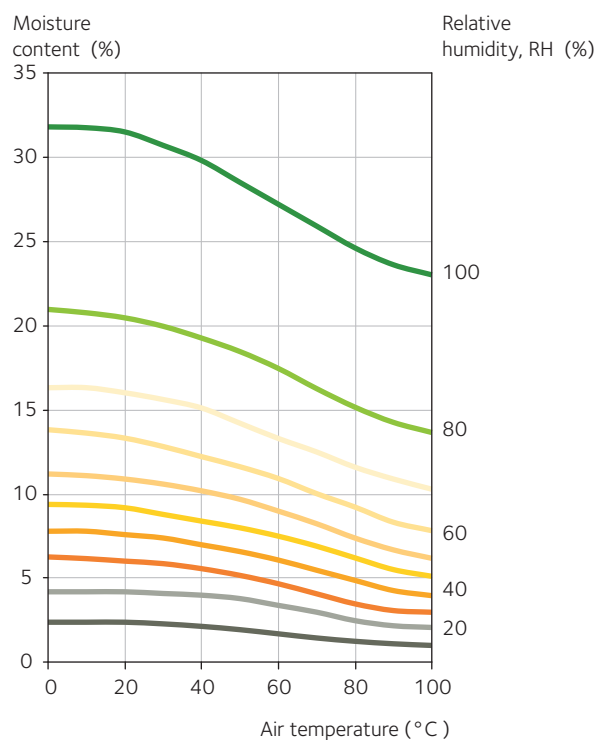

Figure 3.1 The equilibrium moisture content in wood as a function of temperature at different relative humidity (RH) levels.



One family house made of CLT, Skara, Sweden.



Stair with handrail milled in the CLT wall panel.

Service class 2 is characterised by an environment where the relative humidity (RH) exceeds 85 % for only a few weeks per year. This equates to an average moisture content in the CLT that only exceeds 20 % for short periods.

Components in this class include:

- Floor over crawlspace, ventilated with outdoor air.
- CLT structures in premises or buildings that are not permanently heated, such as holiday homes, cold stores, not insulated riding arenas and other buildings.
- CLT structures in badly ventilated indoor pools.

Service class 3 is characterised by an environment that gives a moisture content that exceeds the level in service class 2.

This class includes:

- CLT structures in premises or buildings with moisture-producing operations or moisture-producing storage.
- CLT structures that are entirely unprotected against dampness or in direct contact with the ground.

CLT panels manufactured to the standards of the CE Mark are not intended for use in service class 3, *see also section 3.1.5, page 35*.

3.1.4 Design resistance and stiffness

Designing in the ultimate limit state

Design resistance in the ultimate limit state is determined based on a strength design value. This is calculated by dividing the characteristic value f_k , adjusted to account for the duration and service class using the partial factor γ_M for uncertainty in the material:

$$3.2 \quad f_d = \frac{k_{\text{mod}} \cdot f_k}{\gamma_M}$$

where:

f_k is the characteristic strength value.

k_{mod} is a modification factor that takes account of service class and load duration, *see table 3.3, page 36*.

γ_M is a partial factor for material properties, *see table 3.2, page 35*.

The modification factor k_{mod} is determined based on the duration of the shortest lasting action type in the design load combination. The characteristic values for strength and the conversion factors for different cases are stated in the prevailing norms and standards.

Designing in the serviceability limit state

When designing in the serviceability limit state, it must be proven that the structure has sufficient stiffness to ensure that unwanted vibrations or deformations that degrade the building component's function do not occur. The stiffness of CLT panels and slabs is affected by various factors, such as load duration and the material's moisture content and temperature.

When designing for deformations, account is taken of the above by adjusting the stiffness values based on the service class.

Since we are normally more interested in an accurate estimate of the size of the deformation than on a value that is most likely to lie on the safe side, it is normally used average values of the stiffness in the serviceability limits state design.

The Eurocodes state that if the load case comprises multiple actions of different durations, the deformation is calculated as the sum of

the deformation contributions from the different actions. Each of the contributions is calculated using the material values corresponding to the duration of the respective actions.

The material design values in the serviceability limit state are achieved by first adjusting the value for modulus of elasticity, for example, with reference to the service class. The result is then divided by the partial factor γ_M for uncertainties in the material. As a rule, $\gamma_M = 1.0$ is the value used when designing in the serviceability limit state.

When calculating deformations in the serviceability limit state for structures comprising parts or components with different time-dependency, the mean value for the final modulus of elasticity, $E_{\text{mean,fin}}$, the shear modulus, $G_{\text{mean,fin}}$, and the slip modulus, $K_{\text{ser,fin}}$, are calculated with the help of the following expressions:

$$E_{\text{mean,fin}} = \frac{E_{\text{mean}}}{(1 + k_{\text{def}})}$$

$$G_{\text{mean,fin}} = \frac{G_{\text{mean}}}{(1 + k_{\text{def}})}$$

$$K_{\text{ser,fin}} = \frac{K_{\text{ser}}}{(1 + k_{\text{def}})}$$

where:

- E_{mean} is the mean value of the modulus of elasticity.
- G_{mean} is the mean value of the shear modulus.
- K_{ser} is the slip modulus.
- k_{def} is a modification factor for creep deformation that takes account of the service class.

3.1.5 Partial factor and modification factors

The partial factor γ_M depends in part on the degree of control during design and manufacture, but also on the material's homogeneity. The value of the partial factor γ_M for material properties is usually stated in the national annexes to the Eurocode and differs from country to country. Some countries currently use the same value for CLT as for glulam, while other countries use the values for structural timber. No specific value has been chosen for CLT in Sweden. Depending on your interpretation, 1.25 or 1.3 should be used if the CLT will be used in a building that will be erected in Sweden. The recommended value is 1.25 according to *table 3.2*. If designing CLT for a project in another country, that country's chosen value should be used in line with their prevailing Eurocode national annex.

The next generation of Eurocodes will provide more in-depth calculation rules for CLT structures and thus the material factors and factors for CLT will be more harmonised among the different countries. CLT is not currently used in environments with higher moisture levels than those that occur in service classes 1 and 2. Moisture affects CLT panels by causing local deformations, swelling and shrinkage, which can have a negative impact on the CLT's load-bearing capacity and on joints and fixings.



Boards for the production of CLT.

Table 3.2 Examples of partial factor γ_M when designing CLT.

Country	γ_M
Sweden	1.25
Norway	1.15
Austria	1.25
Germany	1.3

Table 3.3 Values for k_{mod} for CLT.

Service class	Load-duration class				
	Permanent (P)	Long term (L)	Medium term (M)	Short term (S)	Instantaneous (I)
1	0.6	0.7	0.8	0.9	1.1
2	0.6	0.7	0.8	0.9	1.1
3	–	–	–	–	–

Table 3.4 Values for k_{def} for CLT.

Service class	Deformation modification factors, k_{def}	
	No. of layers ≤ 7	No. of layers > 7
1	0.85	0.8
2	1.1	1.0
3	–	–

When it comes to load duration, tests show similar behaviours for CLT as for glulam and structural timber. It is therefore appropriate to assume that the modification factor k_{mod} is the same for CLT as for glulam and structural timber, see table 3.3.

The modification factor for deformation, k_{def} , depends on the service class and the number of board layers, and affects the properties of CLT panels, see table 3.4. This factor is usually stated in the CLT manufacturer’s product sheet or in the manufacturer’s European Technical Approval (ETA).

3.1.6 System effect

Compared with components made from structural timber, the equivalent components in CLT have greater average strength and less of a spread of strength values. The strength of structural timber is determined by the weakest cross-section, which is usually at a knot, finger joint or similar irregularity. The variation between different pieces of timber is therefore considerable. CLT, on the other hand, mixes boards of different strengths and the risk of the weakest cross-sections coinciding in the same direction and layer is small. This is often referred to as the system effect.

When designing CLT components, the characteristic strength and stiffness of the constituent boards is sometimes used. The system strength is particularly pronounced for the bending and tensile effect of CLT, where multiple parallel boards can interact. Calculations on the characteristic strength of the boards, CLT components are likely to have a somewhat higher characteristic strength, as it is not just one but several boards that are being bent or pulled at the same time. No strength classes have yet been developed for CLT, and so the bending and tensile strength can be increased with the help of a system effect factor, k_{sys} .

Different approval documents and handbooks may list different values for k_{sys} , from 0.9 up to 1.2. The factor is determined based on the number of boards in tension and on the extent of the samples, when determining the properties of the panel. Since it is hard to know at an early stage how many boards there are in a cross-section, k_{sys} can be determined as follows:

$$3.6 \quad k_{sys} = \min \left\{ \begin{array}{l} 1.15 \\ 1 + 0.1 \cdot b \end{array} \right.$$

where b is the effective width of the cross-section in m.

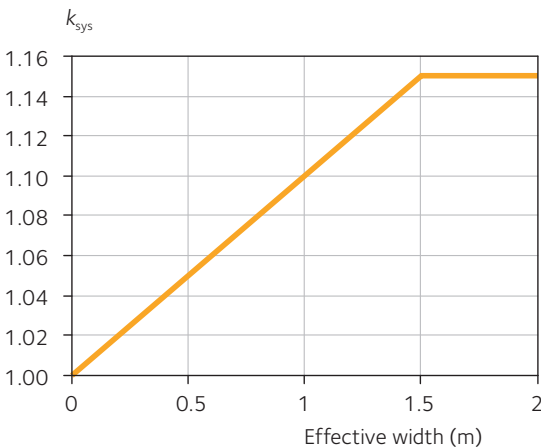

Figure 3.2 System strength factor k_{sys} for CLT for different effective widths.

3.2 Material properties of CLT

CLT comprises at least three and usually a maximum of seven layers of boards, each layer perpendicular to the next, where the cross-section is usually symmetrical with an odd number of layers. This gives us a component with high transverse stiffness and small moisture-related deformations. As a rule, the different layers of boards have the same thickness, but sometimes the inner layers may be thicker or thinner. The layers may also comprise two bonded boards in the same direction. The layers of boards are usually glued together, but other bonding systems also occur (nails, dowels), although these products are not called cross laminated timber, CLT. Some CLT manufacturers glue the edges of the boards, and some make CLT with nine or more layers. CLT tends to be made from soft wood, but there are CLT manufacturers who use other wood species.

The maximum dimensions of the panels are usually around $3 \times 16 \text{ m}^2$, but this varies depending on the CLT manufacturer, and some can make even larger panels. The moisture content for the constituent material should be 8 – 14 % and it should be tailored to the intended area of use. The boards are sorted according to set strength classes and finger-jointed timber is used. If finger-jointed timber is not used, this should be considered when designing the components. The CLT manufacturers take account of this in their reported strength values.

The ultimate properties of the CLT panels are determined by the properties of the constituent boards, but also by the system strength, as mentioned above. The boards used commonly have effect properties in accordance with SS-EN 338 or values reported and verified by the CLT manufacturer.

There are several theories and methods that are accurate and that can be used to calculate the properties of CLT.



7-layer CLT block made from spruce.



3-layer CLT panel made from birch.

Table 3.5 Material properties for strength graded timber used for CLT.

Board properties	C14	C16	C24	C30
Characteristic strength values (MPa)				
Bending strength $f_{m,k}$	14	16	24	30
Tensile strength along the grain $f_{t,0,k}$	7.2	8.5	14.5	19
Tensile strength perpendicular to the grain $f_{t,90,k}$	0.4	0.4	0.4	0.4
Compressive strength along the grain $f_{c,0,k}$	16	17	21	24
Compressive strength perpendicular to the grain $f_{c,90,k}$	2.0	2.2	2.5	2.7
Shear strength $f_{v,k}$	3.0	3.2	4.0	4.0
Stiffness values (MPa)				
Mean value of modulus of elasticity, along the grain $E_{m,0,mean}$	7,000	8,000	11,000	12,000
Fifth percentile value of modulus of elasticity, along the grain $E_{m,0,05}$	4,700	5,400	7,400	8,000
Mean value of modulus of elasticity, perpendicular to the grain $E_{m,90,mean}$	230	270	370	400
Mean value of the shear modulus G_{mean}	440	500	690	750
Density (kg/m³)				
Fifth percentile volume of density ρ_k	290	310	350	380
Mean density ρ_{mean}	350	370	420	460

3.2 Material properties of CLT

Table 3.6 Examples of characteristic strength values for CLT panels based on the strength properties of the timber boards.
About directions, see section 3.3.1, page 40.

Characteristic strength values		CLT panels with only C24 (MPa)	CLT panels with C30 in main direction of load and C14 across main direction of load (MPa)
Bending strength	$f_{m,x,k}$	24	30
	$f_{m,y,k}$	24	14
Tension strength, in plane	$f_{t,0,x,k}$	14.5	19
	$f_{t,0,y,k}$	14.5	7.2
Tension strength, perpendicular to the plane	$f_{t,90,x,k}$	0.4	0.4
	$f_{t,90,y,k}$	0.4	0.4
Compression strength, in plane	$f_{c,0,x,k}$	21	24
	$f_{c,0,y,k}$	21	16
Compression strength, perpendicular to the plane	$f_{c,90,z,k}$	2.5	2.7
Shear strength, longitudinal shear	$f_{v,090,xlay,k}$	4	4
	$f_{v,090,ylay,k}$	4	3
Shear strength, rolling shear	$f_{v,9090,xlay,k}$	1.1 ¹⁾ or 0.7 ²⁾	1.1 ¹⁾ or 0.7 ²⁾
	$f_{v,9090,ylay,k}$	1.1 ¹⁾ or 0.7 ²⁾	1.1 ¹⁾ or 0.7 ²⁾

¹⁾ Used for CLT panels with edge-glued boards or where the board thickness is less than 45 mm and the width to thickness ratio for the boards is equal to or greater than 4.

²⁾ Used for CLT panels where the boards are not edge-glued and where the width to thickness ratio for the boards is less than 4, or where grooves have been cut into the boards.

Table 3.7 Examples of characteristic stiffness values for CLT panels based on the stiffness properties of the timber boards.
About directions, see section 3.3.1, page 40.

Characteristic stiffness values		CLT panels with only C24 (MPa)	CLT panels with C30 in main direction of load and C14 across main direction of load (MPa)
Mean value of modulus of elasticity	$E_{0,x,mean}$	11,000	12,000
	$E_{90,x,mean}$	0 ¹⁾ or 400 ²⁾	0 ¹⁾ or 400 ²⁾
	$E_{0,y,mean}$	11,000	7,000
	$E_{90,y,mean}$	0 ¹⁾ or 400 ²⁾	0 ¹⁾ or 280 ²⁾
Fifth percentile value of modulus of elasticity	$E_{0,x,05}$	7,400	8,000
	$E_{0,y,05}$	7,400	4,700
Mean value of modulus of shear	$G_{090,xlay,mean}$	690	750
	$G_{090,ylay,mean}$	690	440
Mean value of modulus of rolling shear	$G_{9090,xlay,mean}$	50	50
	$G_{9090,ylay,mean}$	50	50

¹⁾ Used for CLT panels without edge-glued boards.

²⁾ May be used for CLT panels with edge-glued boards.

Table 3.8 Density of CLT panels.

Density		CLT panels with only C24 (kg/m ³)	CLT panels with C30 in main direction of load and C14 across main direction of load (kg/m ³)
Characteristic value	$\rho_{xlam,k}$	350	approx. 350
Mean value	$\rho_{xlam,mean}$	420	approx. 420

As part of the process of obtaining approval of CLT products, the boards properties are determined via many samples and using calculation methods and stated boundary conditions, the CLT manufacturers calculate the load-bearing capacity of the CLT panels for different cross-sections.

A structural engineer designing CLT should therefore make use of the CLT manufacturer's recommendations concerning material properties and methods, as far as possible.

According to SS-EN 16351, the mechanical properties of CLT can be determined using the following options:

- By determining and reporting the cross-sectional structure and relevant material properties of the constituent boards.
- By testing the CLT component and reporting the cross-sectional structure and relevant material properties of the constituent boards.

According to SS-EN 16351, as with other construction products, the CLT manufacturer must declare the properties of its products. If the method is used of declaring the CLT panel's properties based on standardised board properties according to SS-EN 338 together with an calculation method, the values obtained are as set out in *table 3.6, page 38, and table 3.7, page 38*.

This means that the stiffness and strength of a CLT panel are determined by the stiffness and strength of the layer. The values are determined for different axes, described as:

- x-axis – parallel with or along the main bearing direction of the CLT panel (usually along the grain of the top layer).
- y-axis – perpendicular to or across the main bearing direction of the CLT panel.
- z-axis – perpendicular to or across the x-y plane of the CLT panel.

See also section 3.3.1, page 40.

The density of CLT panels can be set at 1.1 times the density of the constituent boards in the ultimate limit state and 1.0 times the density of the boards in the serviceability limit state. For CLT panels in which different strengths are used in the different layers, the density for the lowest strength class should be used when calculating joints.

Load calculations usually use a density of between 450 and 550 kg/m³ for CLT panels.



Training facilities for dogs, Rosersberg, Sweden.

3.3 CLT design using beam theory

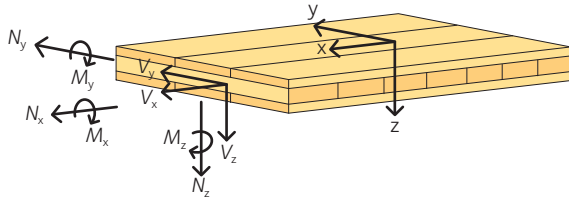

Figure 3.3 Definition of main axes and main directions.

If there is a clear main load direction, a CLT panel can be treated like a beam, as is often the case. The designing can then in principle apply beam theory.

3.3.1 Definition of directions

CLT and products made from CLT can distribute loads in three main directions, along the longitudinal axis (x-axis), along the transverse axis (y-axis) and perpendicular to the plane (z-axis).

The current standard for CLT, SS-EN 16351, uses the following designations, which are also used in this chapter. See also figure 3.3 and figure 3.4:

- the x-axis is parallel with the grain of the outermost layer of boards and this is also known as the global axis in the x-direction. This does not necessarily mean that the greatest bearing capacity occurs along the x-axis.
- the y-axis is perpendicular to the grain of the outermost layer of boards, and this is also known as the global axis in the y-direction.
- the z-axis is perpendicular to the x-y plane and runs along the thickness of the panel. It is also known as the global axis in the z-direction.
- 0 represents local axes for boards or layers, parallel with the grain.
- 90 represents local axes for boards or layers, perpendicular to the grain.
- 090 represents the local plane with a direction of 0 and 90, e.g. shear in a plane parallel with the grain and perpendicular to the grain.
- 9090 represents the local plane with a direction of 90 and 90, e.g. shear in a plane perpendicular to the grain in both directions.

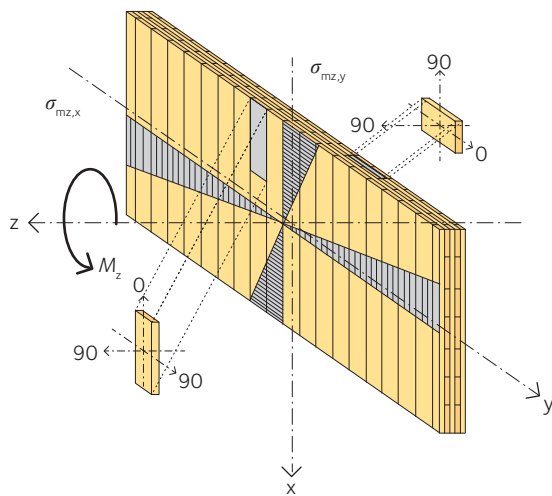

Figure 3.4 View of a CLT wall panel, main axes and local axes.

The following section assumes a symmetrical cross-section and that the modulus of elasticity perpendicular to the grain is negligible, i.e. $E_{mn90} = 0$. It is further assumed that the modulus of elasticity parallel with the grain is the same for all the boards and is designated E_0 . For the mechanical properties of CLT with non-symmetrical cross-sections and heterogeneous cross-sections, see section 3.3.3, page 47.

Designations

The modulus of elasticity per layer is designated as follows:

- E_0 is the modulus of elasticity for a layer parallel with the grain.
- $E_{0,mean}$ is the mean value in line with SS-EN 338.
- $E_{x,i}$ is the modulus of elasticity along the x-axis for the layer i.
- $E_{y,j}$ is the modulus of elasticity along the y-axis for the layer j.

$$E_{x,1} = E_{x,3} = E_{x,5} = \dots = E_{0,xlay,mean} = E_0$$

$$E_{y,2} = E_{y,4} = \dots = E_{0,ylay,mean} = E_0$$

$$E_{x,2} = E_{x,4} = \dots = E_{90,ylay,mean} = 0$$

$$E_{y,1} = E_{y,3} = E_{y,5} = \dots = E_{90,xlay,mean} = 0$$

The shear modulus per layer is designated as follows:

- $G_{x,i}$ is the shear modulus along the x-axis for the layer i.
- $G_{y,j}$ is the shear modulus along the y-axis for the layer j.

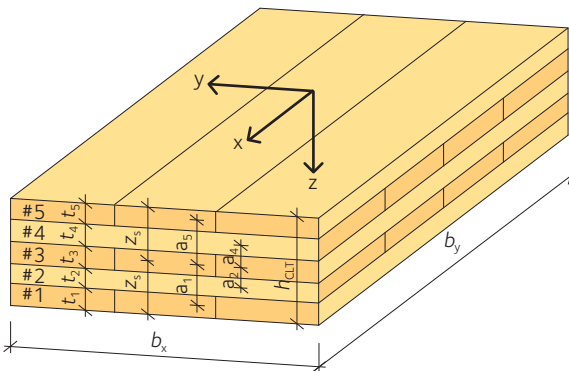

Figure 3.5 Definition of numbering for CLT cross-section with main load along the x-axis.

$$\begin{aligned}
 G_{x,1} = G_{x,3} = G_{x,5} = \dots &= G_{090,xlay,mean} = G_0 \\
 G_{y,2} = G_{y,4} = \dots &= G_{090,ylay,mean} = G_0 \\
 G_{x,2} = G_{x,4} = \dots &= G_{9090,ylay,mean} = G_{90} \\
 G_{y,1} = G_{y,3} = G_{y,5} = \dots &= G_{9090,xlay,mean} = G_{90}
 \end{aligned}$$

The component's thickness, h_{CLT} , and centre of gravity, z_s , can be written as, see figure 3.5, page 40:

$$h_x = t_1 + t_3 + t_5 + \dots \quad 3.7$$

$$h_y = t_2 + t_4 + \dots \quad 3.8$$

$$h_{CLT} = h_x + h_y \quad 3.9$$

$$z_s = \frac{h_{CLT}}{2} \quad 3.10$$

For CLT panels, the axes parallel with the panel are designated with an x and perpendicular to the panel with a y. This must be accounted for with care when designing CLT as a floor component or as a shell component. The stiffness properties indicated with 0 and 90 refer to the properties of the boards and not to the CLT as a homogeneous component.

The shear force capacity is dependent primarily on the rolling shear strength of the transverse layer. The associated net static moments can be written as:

$$S_{R,x,net} = \sum_{i=1}^{m_L} \frac{E_{x,i}}{E_{ref}} \cdot b_x t_i a_i \quad 3.11$$

$$S_{R,y,net} = \sum_{i=1}^{m_L} \frac{E_{y,i}}{E_{ref}} \cdot b_y t_i a_i \quad 3.12$$



ABBA museum, Stockholm, Sweden.

Table 3.9 Cross-section properties of CLT panels. Definitions see figure 3.3, figure 3.4 and figure 3.5, page 40.

Property	Parallel with main direction of load	Perpendicular to main direction of load
Gross area	$A_{x,brutto} = b_x h_{CLT}$	$A_{y,brutto} = b_y h_{CLT}$
Net area	$A_{x,net} = b_x h_x$	$A_{y,net} = b_y h_y$
Net, moment of inertia	<p>With rotation about the y-axis</p> $I_{x,net} = \sum \frac{E_{x,i}}{E_{ref}} \cdot \frac{b_x t_i^3}{12} + \sum \frac{E_{x,i}}{E_{ref}} \cdot b_x t_i a_i^2$ $= \frac{b_x t_1^3}{12} + b_x t_1 a_1^2 + \frac{b_x t_3^3}{12} + b_x t_3 a_3^2 + \frac{b_x t_5^3}{12} + b_x t_5 a_5^2 + \dots$ <p>With rotation about the z-axis:</p> $I_{z,x,net} = \sum \frac{E_{x,i}}{E_{ref}} \cdot \frac{t_i b_x^3}{12} = \frac{t_1 + t_3 + t_5 + \dots}{12} b_x^3$	<p>With rotation about the x-axis:</p> $I_{y,net} = \sum \frac{E_{y,i}}{E_{ref}} \cdot \frac{b_y t_i^3}{12} + \sum \frac{E_{y,i}}{E_{ref}} \cdot b_y t_i a_i^2$ $= \frac{b_y t_2^3}{12} + b_y t_2 a_2^2 + \frac{b_y t_4^3}{12} + b_y t_4 a_4^2 \dots$ <p>With rotation about the z-axis:</p> $I_{z,y,net} = \sum \frac{E_{y,i}}{E_{ref}} \cdot \frac{t_i b_y^3}{12} = \frac{t_2 + t_4 + \dots}{12} b_y^3$
Net, section modulus	$W_{x,net} = \frac{2 \cdot I_{x,net}}{h_{CLT}}$	$W_{y,net} = \frac{2 \cdot I_{y,net}}{h_{CLT}}$



Boards to be used for CLT panels.

where:

- m_L is the designation for the transverse layer nearest to the panel's centre of gravity.
- b_x, b_y is the width of the board layer.
- t_i is the thickness of the board layer.
- a_i is the distance between the centre of the board layer and the CLT panel's neutral axis.
- E_{ref} is the chosen reference value for modulus of elasticity.
- $E_{x,i}, E_{y,i}$ is the board layer's modulus of elasticity.

In specific cases, it may be necessary to also calculate the component's shear force capacity for the longitudinal layer, where the static moments can be written as follows:

If the panel's centre of gravity lies in the layer in question:

$$3.13 \quad S_{x,net} = \sum_{i=1}^{k_L} \frac{E_{x,i}}{E_{ref}} b_x t_i a_i + b_x \frac{\left(\frac{t_k}{2} - a_k\right)^2}{2}$$

$$3.14 \quad S_{y,net} = \sum_{i=1}^{k_L} \frac{E_{y,i}}{E_{ref}} b_y t_i a_i + b_y \frac{\left(\frac{t_k}{2} - a_k\right)^2}{2}$$

If the panel's centre of gravity does not lie in the layer in question:

$$3.15 \quad S_{x,net} = \sum_{i=1}^{k_L} \frac{E_{x,i}}{E_{ref}} b_x t_i a_i$$

$$3.16 \quad S_{y,net} = \sum_{i=1}^{k_L} \frac{E_{y,i}}{E_{ref}} b_y t_i a_i$$

where:

- k_L is the designation for the longitudinal layer nearest to the panel's centre of gravity.
- a_k is the distance from the neutral axis to the centre of gravity of the layer in question.
- t_k is the thickness of the layer in question.

Shear capacity in calculation of deformation:

$$3.17 \quad S_{x,CLT} = \kappa_x \sum G_{x,i} b_x t_i = \kappa_x b_x (G_0 t_1 + G_0 t_2 + G_0 t_3 + \dots)$$

$$3.18 \quad S_{y,CLT} = \kappa_y \sum G_{y,i} b_y t_i = \kappa_y b_y (G_0 t_1 + G_0 t_2 + G_0 t_3 + \dots)$$

See table 3.10, page 43 for shear correction factor κ .

For different layer thicknesses, if the ratio $G_0/G_{90} > 0$ or $E_{90} > 0$, the shear correction factor can be calculated as:

$$\kappa = \frac{\left(\sum (EI + EAa^2) \right)^2}{\sum G_i b t_i \cdot \int_h \frac{S^2(z) E^2(z)}{G(z) b(z)} dz} \quad 3.19$$

Table 3.10 contains the shear correction factor calculated for a number of CLT panels with different cross-sections.

Table 3.10 Shear correction factor κ along the x-axis and y-axis. Assumptions for the properties in the table are: simply supported CLT slab, boards of strength class C24, widths $b_x = b_y = 1,0$ m, $E_{0,mean} = 11.000$ MPa, $E_{90,mean} = 0$ MPa, $G_{090,mean} = 650$ MPa and $G_{9090,mean} = 50$ MPa.

Dimension	Thickness per layer					Strength class per layer					Shear correction factor	
h_{CLT}	t_1	t_2	t_3	t_4	t_5	s_1	s_2	s_3	s_4	s_5	κ_x	κ_y
(mm)	(mm)	(mm)	(mm)	(mm)	(mm)	(SS-EN 338)					–	–
60	20	20	20			C24	C24	C24			0.163	0.722
70	20	30	20			C24	C24	C24			0.161	0.756
80	20	40	20			C24	C24	C24			0.168	0.774
80	30	20	30			C24	C24	C24			0.178	0.677
90	30	30	30			C24	C24	C24			0.163	0.722
100	30	40	30			C24	C24	C24			0.161	0.747
100	40	20	40			C24	C24	C24			0.196	0.637
110	40	30	40			C24	C24	C24			0.172	0.691
120	40	40	40			C24	C24	C24			0.163	0.722
100	20	20	20	20	20	C24	C24	C24	C24	C24	0.194	0.152
120	20	30	20	30	20	C24	C24	C24	C24	C24	0.197	0.169
140	20	40	20	40	20	C24	C24	C24	C24	C24	0.208	0.189
110	20	20	30	20	20	C24	C24	C24	C24	C24	0.212	0.150
130	20	30	30	30	20	C24	C24	C24	C24	C24	0.207	0.156
150	20	40	30	40	20	C24	C24	C24	C24	C24	0.213	0.166
120	20	20	40	20	20	C24	C24	C24	C24	C24	0.234	0.157
140	20	30	40	30	20	C24	C24	C24	C24	C24	0.221	0.153
160	20	40	40	40	20	C24	C24	C24	C24	C24	0.221	0.157
120	30	20	20	20	30	C24	C24	C24	C24	C24	0.188	0.147
140	30	30	20	30	30	C24	C24	C24	C24	C24	0.184	0.165
160	30	40	20	40	30	C24	C24	C24	C24	C24	0.189	0.186
130	30	20	30	20	30	C24	C24	C24	C24	C24	0.204	0.146
150	30	30	30	30	30	C24	C24	C24	C24	C24	0.194	0.152
170	30	40	30	40	30	C24	C24	C24	C24	C24	0.195	0.163
140	30	20	40	20	30	C24	C24	C24	C24	C24	0.221	0.152
160	30	30	40	30	30	C24	C24	C24	C24	C24	0.206	0.150
180	30	40	40	40	30	C24	C24	C24	C24	C24	0.203	0.155
140	40	20	20	20	40	C24	C24	C24	C24	C24	0.189	0.142
160	40	30	20	30	40	C24	C24	C24	C24	C24	0.179	0.162
180	40	40	20	40	40	C24	C24	C24	C24	C24	0.179	0.182
150	40	20	30	20	40	C24	C24	C24	C24	C24	0.203	0.141
170	40	30	30	30	40	C24	C24	C24	C24	C24	0.189	0.149
190	40	40	30	40	40	C24	C24	C24	C24	C24	0.186	0.160
160	40	20	40	20	40	C24	C24	C24	C24	C24	0.219	0.147
180	40	30	40	30	40	C24	C24	C24	C24	C24	0.199	0.146
200	40	40	40	40	40	C24	C24	C24	C24	C24	0.194	0.152

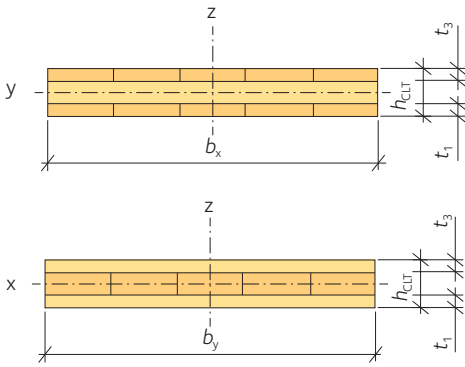

Figure 3.6 Definition of dimensions and numbering for a cross-section of 3-layer CLT panels with the direction of the effective span along the x-axis and the y-axis respectively.

Calculation of torsional resistance and torsional moment of inertia

The torsional resistance of CLT depends on the gross cross-section.

For vertical posts and CLT panels with a risk of rotation or torsional instability, the resistance to torsion should be checked. The moment of inertia for torsion, $I_{\text{tor,CLT}}$ and the cross-section's torsional resistance,

$W_{\text{tor,CLT}}$ can be written as:

$$3.20 \quad I_{\text{tor,x,CLT}} \approx k_{\text{tor}} \cdot c_{1,x} \frac{h_{\text{CLT}}^3 b_x}{3}$$

$$3.21 \quad I_{\text{tor,y,CLT}} \approx k_{\text{tor}} \cdot c_{1,y} \frac{h_{\text{CLT}}^3 b_y}{3}$$

$$3.22 \quad W_{\text{tor,x,CLT}} = \frac{I_{\text{tor,x,CLT}}}{c_{2,x} \cdot h_{\text{CLT}}} = k_{\text{tor}} \cdot \frac{c_{1,x}}{c_{2,x}} \frac{h_{\text{CLT}}^2 b_x}{3}$$

$$3.23 \quad W_{\text{tor,y,CLT}} = \frac{I_{\text{tor,y,CLT}}}{c_{2,y} \cdot h_{\text{CLT}}} = k_{\text{tor}} \cdot \frac{c_{1,y}}{c_{2,y}} \frac{h_{\text{CLT}}^2 b_y}{3}$$

where:

$$k_{\text{tor}} = \begin{cases} 0.65 & \text{for CLT with slits or splits.} \\ 0.8 & \text{for CLT without slits or splits.} \end{cases}$$

h_{CLT} is the thickness of the CLT panel.

b_x is the width and x-direction of the CLT panel.

b_y is the width and y-direction of the CLT panel.

with the following factors:

$$c_{1,x} = 1 - 0.63 \frac{h_{\text{CLT}}}{b_x} + 0.052 \left(\frac{h_{\text{CLT}}}{b_x} \right)^5$$

$$c_{1,y} = 1 - 0.63 \frac{h_{\text{CLT}}}{b_y} + 0.052 \left(\frac{h_{\text{CLT}}}{b_y} \right)^5$$

$$c_{2,x} = 1 - \frac{0.052 \left(\frac{h_{\text{CLT}}}{b_x} \right)^3}{1 + \left(\frac{h_{\text{CLT}}}{b_x} \right)^3}$$

$$c_{2,y} = 1 - \frac{0.052 \left(\frac{h_{\text{CLT}}}{b_y} \right)^3}{1 + \left(\frac{h_{\text{CLT}}}{b_y} \right)^3}$$

The equations do not apply to beams of CLT with a thickness greater than the width of the component.

Polar moment of inertia

The polar moment of inertia relates to the linear distribution of the torsion-induced shear stresses from the centre of the rectangular surface to the outer edge. The polar moment of inertia I_p is somewhat larger than the torsional moment of inertia I_t , as the shear stresses are not linear when the component is twisted:

$$I_p = I_1 + I_2 = \frac{b_{l,x} \cdot b_{l,y}^3}{12} + \frac{b_{l,x}^3 \cdot b_{l,y}}{12}$$

$$W_p = \frac{2 \cdot I_p}{\sqrt{b_{l,x} b_{l,y}}}$$

where $b_{l,x}$ and $b_{l,y}$ are the boards' width along the x- and y-axis respectively.

For $b_{l,x} = b_{l,y} = b_l$ (bonded surfaces between boards along the x- and y-axis):

$$I_p = \frac{b_l^4}{6}$$

$$W_p = \frac{b_l^3}{3}$$

3.25

3.26

3.27



Multi-storey building, Sundbyberg, Sweden.

3.3.2 Cross-section properties for 3-layer and 5-layer CLT panels

There are all sorts of opportunities to vary the cross-sectional structure of the CLT panel. It is this structure that determines the properties of the CLT panel. Below are the quantities for several different structures for 3-layer and 5-layer panels, see table 3.11, table 3.12, page 46, and table 3.13, page 47.

Table 3.11 Cross-section properties for 3-layer CLT panels as in figure 3.6. Conditions: $k_{tor} = 0.65$ (slits between boards), widths b_x and $b_y = 1.0$ m

Dimension (mm)	Thickness per layer (mm)			Cross-section (mm)			Surfaces (cm ²)			Bending along y-axis (cm ⁴ , cm ³)			Bending along x-axis (cm ⁴ , cm ³)		
	t_1	t_2	t_3	h_x	h_y	z_s	$A_{x,net}$	$A_{y,net}$	A_{CLT}	$I_{x,net}$	$W_{x,net}$	$S_{R,x,net}$	$I_{y,net}$	$W_{y,net}$	$S_{R,y,net}$
60	20	20	20	40	20	30	400	200	600	1,733	578	400	67	22	0
70	20	30	20	40	30	35	400	300	700	2,633	752	500	225	64	0
80	20	40	20	40	40	40	400	400	800	3,733	933	600	533	133	0
80	30	20	30	60	20	40	600	200	800	4,200	1,050	750	67	17	0
90	30	30	30	60	30	45	600	300	900	5,850	1,300	900	225	50	0
100	30	40	30	60	40	50	600	400	1,000	7,800	1,560	1,050	533	107	0
100	40	20	40	80	20	50	800	200	1,000	8,267	1,653	1,200	67	13	0
110	40	30	40	80	30	55	800	300	1,100	10,867	1,976	1,400	225	41	0
120	40	40	40	80	40	60	800	400	1,200	13,867	2,311	1,600	533	89	0

3.3 CLT design using beam theory

Table 3.12 Input data for 5-layer CLT panels as in *figure 3.7*.
Conditions: $k_{\text{tor}} = 0.65$ (slits between boards), widths b_x and $b_y = 1.0$ m.

No.	Dimension (mm)	Thickness per layer (mm)					Cross-section (mm)			Weight and area (kg/m ² , cm ²)				
	h_{CLT}	t_1	t_2	t_3	t_4	t_5	h_x	h_y	z_s	g_{mean}	g_k	$A_{x,\text{net}}$	$A_{y,\text{net}}$	A_{CLT}
1	100	20	20	20	20	20	60	40	50	42	39	600	400	1,000
2	120	20	30	20	30	20	60	60	60	50	46	600	600	1,200
3	140	20	40	20	40	20	60	80	70	59	54	600	800	1,400
4	110	20	20	30	20	20	70	40	55	46	42	700	400	1,100
5	130	20	30	30	30	20	70	60	65	55	50	700	600	1,300
6	150	20	40	30	40	20	70	80	75	63	58	700	800	1,500
7	120	20	20	40	20	20	80	40	60	50	46	800	400	1,200
8	140	20	30	40	30	20	80	60	70	59	54	800	600	1,400
9	160	20	40	40	40	20	80	80	80	67	62	800	800	1,600
10	120	30	20	20	20	30	80	40	60	50	46	800	400	1,200
11	140	30	30	20	30	30	80	60	70	59	54	800	600	1,400
12	160	30	40	20	40	30	80	80	80	67	62	800	800	1,600
13	130	30	20	30	20	30	90	40	65	55	50	900	400	1,300
14	150	30	30	30	30	30	90	60	75	63	58	900	600	1,500
15	170	30	40	30	40	30	90	80	85	71	66	900	800	1,700
16	140	30	20	40	20	30	100	40	70	59	54	1,000	400	1,400
17	160	30	30	40	30	30	100	60	80	67	62	1,000	600	1,600
18	180	30	40	40	40	30	100	80	90	76	70	1,000	800	1,800
19	140	40	20	20	20	40	100	40	70	59	54	1,000	400	1,400
20	160	40	30	20	30	40	100	60	80	67	62	1,000	600	1,600
21	180	40	40	20	40	40	100	80	90	76	70	1,000	800	1,800
22	150	40	20	30	20	40	110	40	75	63	58	1,100	400	1,500
23	170	40	30	30	30	40	110	60	85	71	66	1,100	600	1,700
24	190	40	40	30	40	40	110	80	95	80	73	1,100	800	1,900
25	160	40	20	40	20	40	120	40	80	67	62	1,200	400	1,600
26	180	40	30	40	30	40	120	60	90	76	70	1,200	600	1,800
27	200	40	40	40	40	40	120	80	100	84	77	1,200	800	2,000

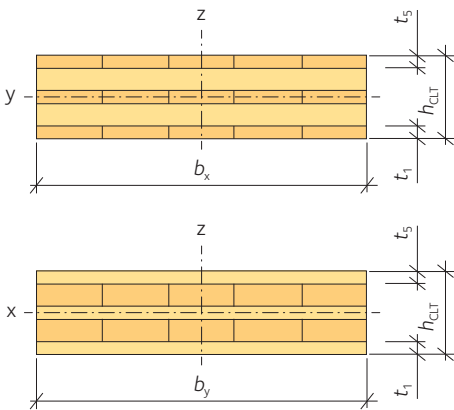

Figure 3.7 Definition of dimensions and numbering for a cross-section of 5-layer CLT panels with the direction of the effective span along the x-axis and the y-axis respectively.

Table 3.13 Cross-section properties for 5-layer CLT panels as in figure 3.7, page 47.
 Conditions: $k_{tor} = 0.65$ (slits between boards), widths b_x and $b_y = 1.0$ m.

No.	Dimension (mm)	Thickness per layer (mm)					Bending along y-axis (cm ⁴ , cm ³)			Bending along x-axis (cm ⁴ , cm ³)		
		h_{CLT}	t_1	t_2	t_3	t_4	t_5	$I_{x,net}$	$W_{x,net}$	$S_{R,x,net}$	$I_{y,net}$	$W_{y,net}$
1	100	20	20	20	20	20	6,600	1,320	800	1,733	346.7	400
2	120	20	30	20	30	20	10,200	1,700	1,000	4,200	700.0	750
3	140	20	40	20	40	20	14,600	2,086	1,200	8,267	1,181.0	1,200
4	110	20	20	30	20	20	8,458	1,538	900	2,633	478.8	500
5	130	20	30	30	30	20	12,458	1,917	1,100	5,850	900.0	900
6	150	20	40	30	40	20	17,258	2,301	1,300	10,867	1,448.9	1,400
7	120	20	20	40	20	20	10,667	1,778	1,000	3,733	622.2	600
8	140	20	30	40	30	20	15,067	2,152	1,200	7,800	1,114.3	1,050
9	160	20	40	40	40	20	20,267	2,533	1,400	13,867	1,733.0	1,600
10	120	30	20	20	20	30	12,667	2,111	1,350	1,733	289.0	400
11	140	30	30	20	30	30	18,667	2,667	1,650	4,200	600.0	750
12	160	30	40	20	40	30	25,867	3,233	1,950	8,267	1,033.0	1,200
13	130	30	20	30	20	30	15,675	2,411	1,500	2,633	405.0	500
14	150	30	30	30	30	30	22,275	2,970	1,800	5,850	780.0	900
15	170	30	40	30	40	30	30,075	3,538	2,100	10,867	1,278.0	1,400
16	140	30	20	40	20	30	19,133	2,733	1,650	3,733	533.0	600
17	160	30	30	40	30	30	26,333	3,292	1,950	7,800	975.0	1,050
18	180	30	40	40	40	30	34,733	3,859	2,250	13,867	1,541.0	1,600
19	140	40	20	20	20	40	21,133	3,019	2,000	1,733	248.0	400
20	160	40	30	20	30	40	29,933	3,742	2,400	4,200	525.0	750
21	180	40	40	20	40	40	40,333	4,482	2,800	8,267	919.0	1,200
22	150	40	20	30	20	40	25,492	3,399	2,200	2,633	351.0	500
23	170	40	30	30	30	40	35,092	4,128	2,600	5,850	688.0	900
24	190	40	40	30	40	40	46,292	4,873	3,000	10,867	1,144.0	1,400
25	160	40	20	40	20	40	30,400	3,800	2,400	3,733	467.0	600
26	180	40	30	40	30	40	40,800	4,533	2,800	7,800	867.0	1,050
27	200	40	40	40	40	40	52,800	5,280	3,200	13,867	1,387.0	1,600

3.3.3 Non-symmetrical cross-section and layers with different modulus of elasticity

Non-symmetrical cross-sections, see figure 3.8, may occur, although they should be avoided as they increase the risk of varied deformations and moisture-related movement. Below is a general method for calculating cross-section quantities, see the equations 3.28–3.31, page 48 for non-symmetrical cross-sections.

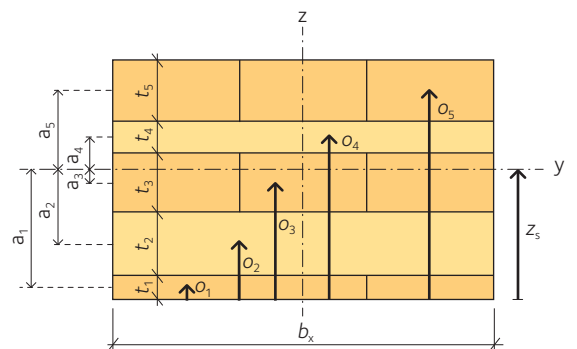

Figure 3.8 Structure and numbering of a non-symmetrical cross-section.

The centre of gravity of the cross-section is determined as follows:

- A reference layer is determined with E_{ref} as the modulus of elasticity.
- Calculate the centre of gravity for each layer from the lower edge of the cross-section, $o_1, o_2, o_3, \dots, o_i$.
- Calculate the z-coordinate from the lower edge of the cross-section:

$$3.28 \quad z_s = \frac{\sum \frac{E_i}{E_{\text{ref}}} b \cdot t_i o_i}{\sum \frac{E_i}{E_{\text{ref}}} b \cdot t_i}$$

- Now the distance a_i between the centre of each layer and the CLT panel's neutral axis can be determined:

$$a_i = |o_i - z_s|$$

Calculate the net area, with the load along the x-axis:

$$3.29 \quad A_{x,\text{net}} = \sum \frac{E_i}{E_{\text{ref}}} b_x t_i$$

Calculate the net-moment of inertia, with the load along the x-axis:

$$3.30 \quad I_{x,\text{net}} = \sum \frac{E_i}{E_{\text{ref}}} \cdot \frac{b_x t_i^3}{12} + \sum \frac{E_i}{E_{\text{ref}}} b_x t_i a_i^2$$

Calculate the moment of resistance, with the load along the x-axis:

$$3.31 \quad W_{x,\text{net}} = \frac{I_{x,\text{net}}}{\max\{|z_o|; |z_u|\}}$$

With $z_u = z_s$ and $z_o = h - |z_s|$

When determining the stress under the moment of resistance $M_{y,d}$ the following can be used:

$$\sigma_{m,y,d} = \frac{E_i}{E_{\text{ref}}} \cdot \frac{M_{y,d}}{W_{x,\text{net}}}$$

where:

- E_i is the modulus of elasticity of the individual layer.
- E_{ref} is the chosen reference value for modulus of elasticity.

3.3.4 Effective cross-section

Shear deformation makes up a significant part of the total deformation in CLT panels. Eurocode 5, annex B describes the Gamma method, where deformations from shear forces are addressed in a simplified way. For pure bending, the bending stiffness is calculated with the net cross-section and is designated EI_{net} . The Gamma method instead introduces an effective moment of inertia, I_{ef} in the calculation.

The formulas for the Gamma method in Eurocode 5 can be used for cross-sections with 3- and 5-layer panels. The theory in both cases takes the second longitudinal layer from the upper side as the base

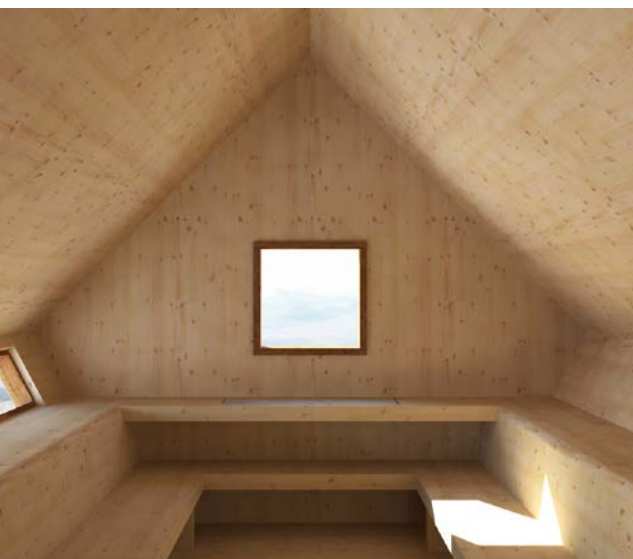

Cabin, Kebnekaise, Sweden.

layer. The adjacent layers are flexibly connected to the base layer and each layer's "Steiner" part is reduced by a Gamma value that depends on the span and the transverse layers. For cross-sections with two transverse layers, the associated formulas result in non-symmetrical sub-results. The method is easily implemented for 3- and 5-layer components but requires more in-depth calculations for layers of 7 or more.

For this method, the cross-section values are dependent on the component's length or span l_{ref} is therefore named as a reference length which depends on the length and support system of the beam:

- for a simply supported beam with a single span, $l_{ref} = L$.
- for a simply supported continuous beam with at least two spans, $l_{ref} = 0.8 \cdot L$ (L is the specific span in question).
- for a cantilevered beam
 $l_{ref} = 2 \cdot L$ (L is the length of the cantilever).

3-layer CLT

The CLT panel may have layers of different thicknesses and strength classes, see figure 3.9.

When calculating cross-section sizes, the following process and equations 3.32 – 3.35 can be used.

- Each layer is numbered from 1 to n from the bottom up.
- Calculate the Gamma values. γ_3 only needs to be calculated for the longitudinal layers, i.e. layer 1 and layer 3. The transverse layer is not counted:

$$\gamma_1 = 1 \tag{3.32}$$

$$\gamma_3 = \frac{1}{1 + \frac{\pi^2 E_{x,3} t_3}{l_{ref}^2} \cdot \frac{t_2}{G_{9090,2}}} \tag{3.33}$$

- Calculate the distance a : a_1 , a_3 . Only a_1 and a_3 for the longitudinal layers 1 and 3 need to be calculated. The transverse layer is not included:

$$a_1 = \frac{\gamma_3 \frac{E_{x,3}}{E_{ref}} b t_3 \left(\frac{t_1}{2} + t_2 + \frac{t_3}{2} \right)}{\gamma_1 \frac{E_{x,1}}{E_{ref}} b t_1 + \gamma_3 \frac{E_{x,3}}{E_{ref}} b t_3}$$

for symmetrical cross-sections and boards of the same strength class:

$$a_1 = \frac{t_1}{2} + \frac{t_2}{2}$$

$$a_3 = \frac{t_1}{2} + t_2 + \frac{t_3}{2} - a_1$$

for symmetrical cross-sections and boards of the same strength class:

$$a_3 = \frac{t_2}{2} + \frac{t_3}{2}$$

- Calculate the effective moment of inertia as follows:

$$I_{x,ef} = \sum \frac{E_{x,i} b_i t_i^3}{E_{ref} 12} + \gamma_i \frac{E_{x,i}}{E_{ref}} b_i t_i a_i^2 = \frac{E_{x,1}}{E_{ref}} \cdot \frac{b_1 t_1^3}{12} + \gamma_1 \frac{E_{x,1}}{E_{ref}} b_1 t_1 a_1^2 + \frac{E_{x,3}}{E_{ref}} \cdot \frac{b_3 t_3^3}{12} + \gamma_3 \frac{E_{x,3}}{E_{ref}} b_3 t_3 a_3^2 \tag{3.34}$$

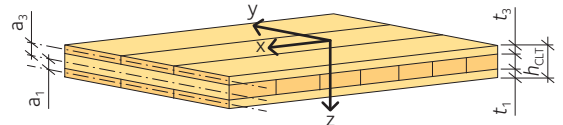

Figure 3.9 Definition of layers and directions.

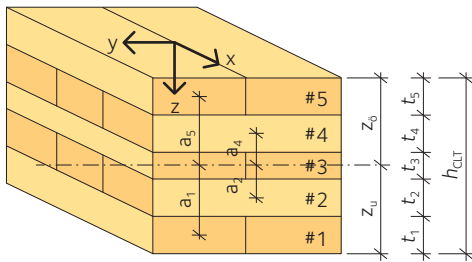

Figure 3.10 Designations for a 5-layer CLT.

For symmetrical cross-sections ($t_1 = t_3$) and the same strength the equation is:

$$3.35 \quad I_{x,ef} = \frac{b_x t_1^3}{12} + b_x t_1 a_1^2 + \frac{b_x t_3^3}{12} + \gamma_3 b_x t_3 a_3^2 = b_x \left(\frac{2 \cdot t_1^3}{12} + (1 + \gamma_3) t_1 a_1^2 \right)$$

5-layer CLT

The CLT panel may have layers of different thicknesses and strength classes, see figure 3.10.

- Each layer is numbered from 1 to n from the bottom up.
- Calculate the Gamma values. γ_3 only needs to be calculated for the longitudinal layers, i.e. layers 1, 3 and 5. The transverse layers are not included and the Gamma value is worked out using equations 3.36 – 3.38:

$$3.36 \quad \gamma_1 = \frac{1}{1 + \frac{\pi^2 E_{x,1} t_1}{l_{ref}^2} \frac{t_2}{G_{9090,2}}}$$

$$3.37 \quad \gamma_3 = 1$$

$$3.38 \quad \gamma_5 = \frac{1}{1 + \frac{\pi^2 E_{x,5} t_5}{l_{ref}^2} \frac{t_4}{G_{9090,4}}}$$

For symmetrical cross-sections ($t_1 = t_3 = t_5$) and the same strength, $\gamma_1 = \gamma_5$.

- Calculate the distance a_i . Only a_1 , a_3 and a_5 for the longitudinal layers 1, 3 and 5 need to be calculated:

$$a_3 = \frac{\gamma_1 \frac{E_{x,1}}{E_{ref}} b t_1 \left(\frac{t_1}{2} + t_2 + \frac{t_3}{2} \right) - \gamma_5 \frac{E_{x,5}}{E_{ref}} b t_5 \left(\frac{t_3}{2} + t_4 + \frac{t_5}{2} \right)}{\gamma_1 \frac{E_{x,1}}{E_{ref}} b t_1 + \gamma_3 \frac{E_{x,3}}{E_{ref}} b t_3 + \gamma_5 \frac{E_{x,5}}{E_{ref}} b t_5}$$

Table 3.14 Effective cross-section properties for 3-layer CLT as in figure 3.11, page 51.

l_{ref} is the span for a simply supported CLT, $b_x = 1.0$ metre. Boards in strength class C24. Bending about the y-axis.

Dimension (mm)	Layer thickness (mm)			Weight (kg/m ²)		$l_{x,full}$ (cm ⁴)	$l_{ref} = 2$ m		$l_{ref} = 2.5$ m		$l_{ref} = 3$ m	
	t_1	t_2	t_3	g_{mean}	g_k		$l_{x,ef}$ (cm ⁴)	$i_{x,ef}$ (cm)	$l_{x,ef}$ (cm ⁴)	$i_{x,ef}$ (cm)	$l_{x,ef}$ (cm ⁴)	$i_{x,ef}$ (cm)
h_{CLT}	t_1	t_2	t_3	g_{mean}	g_k	$l_{x,full}$	$l_{x,ef}$	$i_{x,ef}$	$l_{x,ef}$	$i_{x,ef}$	$l_{x,ef}$	$i_{x,ef}$
60	20	20	20	25	23	1,800	1,591	1.99	1,636	2.02	1,663	2.04
70	20	30	20	29	27	2,858	2,326	2.41	2,418	2.46	2,475	2.49
80	20	40	20	34	31	4,267	3,188	2.82	3,342	2.89	3,442	2.93
80	30	20	30	34	31	4,267	3,739	2.50	3,877	2.54	3,963	2.57
90	30	30	30	38	35	6,075	4,964	2.88	5,207	2.95	5,368	2.99
100	30	40	30	42	39	8,333	6,350	3.25	6,719	3.35	6,975	3.41
100	40	20	40	42	39	8,333	7,177	3.00	7,484	3.06	7,684	3.10

For symmetrical cross-section ($t_1 = t_3 = t_5$) and same grade, $a_3 = 0$.

$$a_1 = \frac{t_1}{2} + t_2 + \frac{t_3}{2} - a_3$$

$$a_5 = \frac{t_3}{2} + t_4 + \frac{t_5}{2} + a_3$$

- Calculate the effective moment of inertia using equations 3.39 and 3.40:

$$I_{x,ef} = \sum \frac{E_{x,i}}{E_{ref}} \cdot \frac{b_x t_i^3}{12} + \gamma_i \frac{E_{x,i}}{E_{ref}} b_x t_i a_i^2$$

3.39

$$: \frac{E_{x,1}}{E_{ref}} \cdot \frac{b_x t_1^3}{12} + \gamma_1 \frac{E_{x,1}}{E_{ref}} b_x t_1 a_1^2 + \frac{E_{x,3}}{E_{ref}} \cdot \frac{b_x t_3^3}{12} + \gamma_3 \frac{E_{x,3}}{E_{ref}} b_x t_3 a_3^2 + \frac{E_{x,5}}{E_{ref}} \cdot \frac{b_x t_5^3}{12} + \gamma_5 \frac{E_{x,5}}{E_{ref}} b_x t_5 a_5^2$$

For symmetrical cross-section ($t_1 = t_3 = t_5$) and same grade:

$$I_{x,ef} = \frac{b_x t_1^3}{12} + \gamma_1 b_x t_1 a_1^2 + \frac{b_x t_3^3}{12} + \frac{b_x t_5^3}{12} + \gamma_5 b_x t_5 a_5^2 = b_x \left(\frac{3 \cdot t_1^3}{12} + 2\gamma_1 t_1 a_1^2 \right)$$

3.40

Effective radius of inertia

When checking structures where there is a risk of buckling, the effect of shearing in the transverse layer should also be considered. This is done by calculating the effective buckling length l_e as the reference length l_{ref} based on the effective moment of inertia I_{ef} , see equations 3.41 and 3.42:

$$i_{x,ef} = \sqrt{\frac{I_{x,ef}}{A_{x,net}}}$$

$$i_{y,ef} = \sqrt{\frac{I_{y,ef}}{A_{y,net}}}$$

Table 3.14 Cont. >>>

$l_{ref} = 4 \text{ m}$		$l_{ref} = 5 \text{ m}$		$l_{ref} = 6 \text{ m}$	
(cm ⁴)	(cm)	(cm ⁴)	(cm)	(cm ⁴)	(cm)
$I_{x,ef}$	$i_{x,ef}$	$I_{x,ef}$	$i_{x,ef}$	$I_{x,ef}$	$i_{x,ef}$
1,692	2.06	1,706	2.07	1,714	2.07
2,539	2.52	2,571	2.54	2,590	2.54
3,557	2.98	3,616	3.01	3,650	3.02
4,059	2.60	4,107	2.62	4,135	2.63
5,556	3.04	5,654	3.07	5,711	3.09
7,285	3.48	7,453	3.52	7,552	3.55
7,914	3.15	8,033	3.17	8,101	3.18



Cross-section CLT.

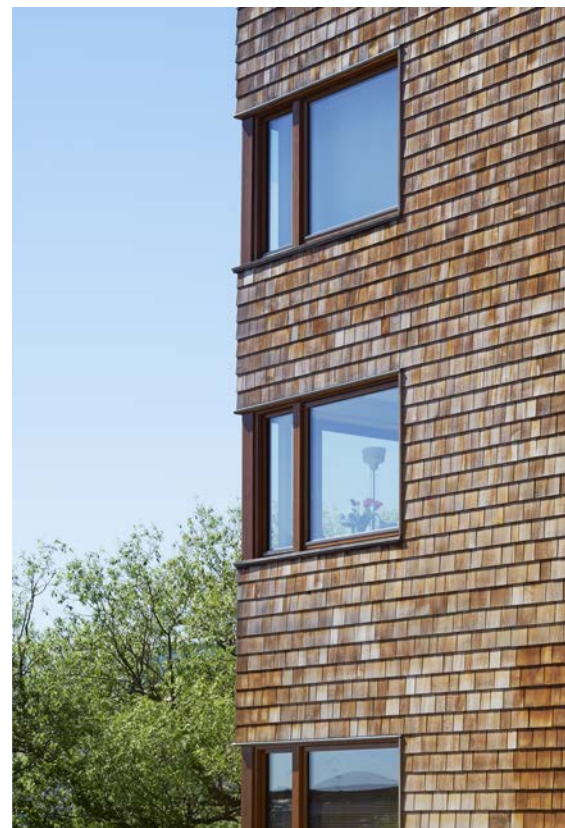

3.42

Multi-storey house, Sundbyberg, Sweden.

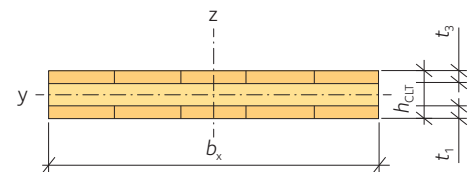

Figure 3.11 Definition of dimensions and numbering for a cross-section of 3-layer CLT panels with bending about the y-axis.

Table 3.15 Effective cross-section properties for 5-layer CLT panels as in figure 3.12, page 53.

l_{ref} is the span for a simply supported CLT, $b_x = 1.0$ m. Boards in strength class C24. Bending about the y-axis.

Dimension (mm)	Layer thickness (mm)					Weight (kg/m ²)		$I_{x,full}$ (cm ⁴)	$l_{ref} = 2,5$ m		$l_{ref} = 3$ m		$l_{ref} = 4$ m	
	t_1	t_2	t_3	t_4	t_5	g_{mean}	g_k		$I_{x,ef}$ (cm ⁴)	$i_{x,ef}$ (cm)	$I_{x,ef}$ (cm ⁴)	$i_{x,ef}$ (cm)	$I_{x,ef}$ (cm ⁴)	$i_{x,ef}$ (cm)
h_{CLT}														
100	20	20	20	20	20	42.0	38.5	8,333	5,819	3.11	6,037	3.17	6,270	3.23
120	20	30	20	30	20	50.4	46.2	14,400	8,475	3.76	8,935	3.86	9,447	3.97
140	20	40	20	40	20	58.8	53.9	22,867	11,468	4.37	12,270	4.52	13,190	4.69
110	20	20	30	20	20	46.2	42.4	11,092	7,470	3.27	7,745	3.33	8,041	3.39
130	20	30	30	30	20	54.6	50.1	18,308	10,371	3.85	10,928	3.95	11,547	4.06
150	20	40	30	40	20	63.0	57.8	28,125	13,583	4.41	14,524	4.56	15,603	4.72
120	20	20	40	20	20	50.4	46.2	14,400	9,447	3.44	9,787	3.50	10,152	3.56
140	20	30	40	30	20	58.8	53.9	22,867	12,583	3.97	13,246	4.07	13,982	4.18
160	20	40	40	40	20	67.2	61.6	34,133	16,004	4.47	17,096	4.62	18,347	4.79
120	30	20	20	20	30	50.4	46.2	14,400	10,571	3.64	11,130	3.73	11,752	3.83
140	30	30	20	30	30	58.8	53.9	22,867	14,343	4.23	15,429	4.39	16,691	4.57
160	30	40	20	40	30	67.2	61.6	34,133	18,408	4.80	20,175	5.02	22,317	5.28
130	30	20	30	20	30	54.6	50.1	18,308	13,088	3.81	13,778	3.91	14,546	4.02
150	30	30	30	30	30	63.0	57.8	28,125	17,130	4.36	18,422	4.52	19,924	4.71
170	30	40	30	40	30	71.4	65.5	40,942	21,425	4.88	23,474	5.11	25,958	5.37
140	30	20	40	20	30	58.8	53.9	22,867	16,003	4.00	16,838	4.10	17,767	4.22
160	30	30	40	30	30	67.2	61.6	34,133	20,295	4.51	21,811	4.67	23,574	4.86
180	30	40	40	40	30	75.6	69.3	48,600	24,803	4.98	27,156	5.21	30,007	5.48
140	40	20	20	20	40	58.8	53.9	22,867	16,784	4.10	17,898	4.23	19,175	4.38
160	40	30	20	30	40	67.2	61.6	34,133	21,460	4.63	23,467	4.84	25,900	5.09
180	40	40	20	40	40	75.6	69.3	48,600	26,328	5.13	29,416	5.42	33,340	5.77
150	40	20	30	20	40	63.0	57.8	28,125	20,229	4.29	21,577	4.43	23,122	4.58
170	40	30	30	30	40	71.4	65.5	40,942	25,147	4.78	27,503	5.00	30,358	5.25
190	40	40	30	40	40	79.8	73.2	57,158	30,215	5.24	33,759	5.54	38,264	5.90
160	40	20	40	20	40	67.2	61.6	34,133	24,136	4.48	25,741	4.63	27,580	4.79
180	40	30	40	30	40	75.6	69.3	48,600	29,266	4.94	31,999	5.16	35,310	5.42
200	40	40	40	40	40	84.0	77.0	66,667	34,508	5.36	38,541	5.67	43,666	6.03

3.3.5 Designing in the ultimate limit state

Control of tension in the CLT plane

For a CLT panel subjected to tension parallel with the surface layer, see figure 3.13, use equation 3.43:

$$3.43 \quad \sigma_{t,x,d} = \frac{F_{t,x,d}}{A_{x,net}} \leq f_{t,0,xlay,d} = k_{sys} \cdot k_{mod} \frac{f_{t,0,xlay,k}}{\gamma_M}$$

where:

- $F_{t,x,d}$ is the design value for tension along the x-axis.
- $A_{x,net}$ is the cross-section's effective net area along the x-axis.
- $f_{t,0,xlay,d}$ is the tensile strength design value for boards along the x-axis.
- $f_{t,0,xlay,k}$ is the characteristic tensile strength for boards along the x-axis.
- k_{sys} is a system factor, see section 3.1.6, page 36.
- k_{mod} is a modification factor, see section 3.1.5, page 35.
- γ_M is the partial factor for the material, see section 3.1.5, page 35.

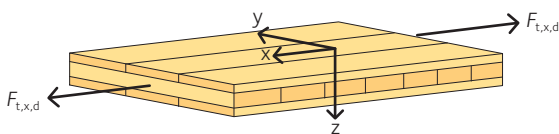

Figure 3.13 CLT panels with tension parallel with surface layer.

Table 3.15 Cont. >>>

$l_{ref} = 5\text{ m}$		$l_{ref} = 6\text{ m}$		$l_{ref} = 7\text{ m}$		$l_{ref} = 8\text{ m}$	
(cm ⁴)	(cm)	(cm ⁴)	(cm)	(cm ⁴)	(cm)	(cm ⁴)	(cm)
$I_{x,ef}$	$i_{x,ef}$	$I_{x,ef}$	$i_{x,ef}$	$I_{x,ef}$	$i_{x,ef}$	$I_{x,ef}$	$i_{x,ef}$
6,385	3.26	6,449	3.28	6,489	3.29	6,514	3.30
9,705	4.02	9,851	4.05	9,941	4.07	10,001	4.08
13,664	4.77	13,937	4.82	14,107	4.85	14,219	4.87
8,186	3.42	8,268	3.44	8,317	3.45	8,350	3.45
11,859	4.12	12,036	4.15	12,145	4.17	12,217	4.18
16,160	4.80	16,480	4.85	16,680	4.88	16,812	4.90
10,331	3.59	10,431	3.61	10,493	3.62	10,533	3.63
14,353	4.24	14,564	4.27	14,694	4.29	14,779	4.30
18,993	4.87	19,364	4.92	19,596	4.95	19,749	4.97
12,065	3.88	12,242	3.91	12,352	3.93	12,424	3.94
17,351	4.66	17,732	4.71	17,971	4.74	18,129	4.76
23,474	5.42	24,156	5.49	24,587	5.54	24,875	5.58
14,932	4.07	15,151	4.10	15,287	4.12	15,376	4.13
20,709	4.80	21,163	4.85	21,447	4.88	21,635	4.90
27,300	5.51	28,091	5.59	28,591	5.64	28,925	5.67
18,234	4.27	18,499	4.30	18,663	4.32	18,771	4.33
24,495	4.95	25,028	5.00	25,361	5.04	25,582	5.06
31,548	5.62	32,455	5.70	33,029	5.75	33,413	5.78
19,834	4.45	20,213	4.50	20,449	4.52	20,605	4.54
27,215	5.22	27,990	5.29	28,479	5.34	28,807	5.37
35,551	5.96	36,883	6.07	37,738	6.14	38,315	6.19
23,919	4.66	24,378	4.71	24,663	4.74	24,852	4.75
31,901	5.39	32,810	5.46	33,385	5.51	33,769	5.54
40,801	6.09	42,331	6.20	43,312	6.27	43,975	6.32
28,529	4.88	29,074	4.92	29,414	4.95	29,639	4.97
37,100	5.56	38,154	5.64	38,821	5.69	39,267	5.72
46,553	6.23	48,294	6.34	49,410	6.42	50,164	6.47

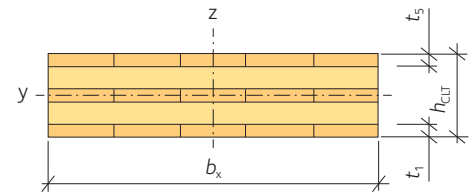

Figure 3.12 Definition of dimensions and numbering for a cross-section of 5-layer CLT panel with bending about the y-axis.

For a CLT subjected to tension perpendicular to the surface layer, see figure 3.14, use equation 3.44:

$$\sigma_{t,y,d} = \frac{F_{t,y,d}}{A_{y,net}} \leq f_{t,0,y,lay,d} = k_{sys} \cdot k_{mod} \frac{f_{t,0,y,lay,k}}{\gamma_M} \tag{3.44}$$

where:

- $F_{t,y,d}$ is the design value for tension along the y-axis.
- $A_{y,net}$ is the cross-section's effective net area along the y-axis.
- $f_{t,0,y,lay,d}$ is the tensile strength design value for boards along the y-axis.
- $f_{t,0,y,lay,k}$ is the characteristic tensile strength for boards along the y-axis.

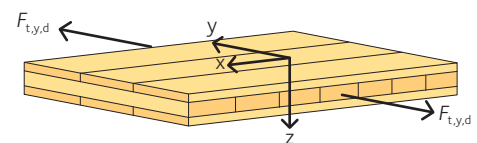

Figure 3.14 CLT panel with tension perpendicular to the surface layer.

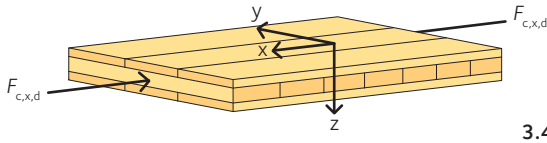

Figure 3.15 CLT panel with compressive force parallel with surface layer.

3.45

Control of compression in the CLT plane without risk of buckling
 For a CLT panel subjected to compression parallel with the surface layer, see figure 3.15, use equation 3.45:

$$\sigma_{c,x,d} = \frac{F_{c,x,d}}{A_{x,net}} \leq f_{c,0,xlay,d} = k_{mod} \frac{f_{c,0,xlay,k}}{\gamma_M}$$

where:

- $F_{c,x,d}$ is the design value for compression force along the x-axis.
- $A_{x,net}$ is the cross-section's effective net area along the x-axis.
- $f_{c,0,xlay,d}$ is the compression strength design value for boards along the x-axis.
- $f_{c,0,xlay,k}$ is the characteristic compression strength for boards along the x-axis.
- k_{mod} is a modification factor, see section 3.1.5, page 35.
- γ_M is the partial factor for the material, see section 3.1.5, page 35.

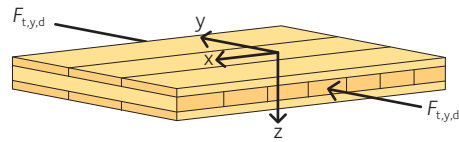

Figure 3.16 CLT panel with compression force perpendicular to the surface layer.

3.46

For a CLT panel subjected to compression force perpendicular to the surface layer, see figure 3.16, use equation 3.46:

$$\sigma_{c,y,d} = \frac{F_{c,y,d}}{A_{y,net}} \leq f_{c,0,ylay,d} = k_{mod} \frac{f_{c,0,ylay,k}}{\gamma_M}$$

where:

- $F_{c,y,d}$ is the design value for compression force along the y-axis.
- $A_{y,net}$ is the cross-section's effective net area along the y-axis.
- $f_{c,0,ylay,d}$ is the compression strength design value for boards along the y-axis.
- $f_{c,0,ylay,k}$ is the characteristic compression strength for boards along the y-axis.

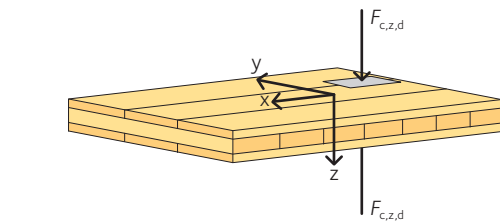

Figure 3.17 CLT panel with compression force perpendicular to its plane.

3.47

Control of compression stress perpendicular to the CLT plane
 For a CLT panel subjected to compression force perpendicular to its plane, see figure 3.17, use equation 3.47:

$$\sigma_{c,z,d} = \frac{F_{c,z,d}}{A_{ef}} \leq f_{c,90,xlay,d} = k_{c,90} \cdot k_{mod} \frac{f_{c,90,xlay,k}}{\gamma_M}$$

where:

- $F_{c,z,d}$ is the design value for compression force perpendicular to the grain.
- A_{ef} is the effective contact area with compression force perpendicular to the grain.
- $f_{c,90,xlay,d}$ is the design value for compression strength perpendicular to the grain.
- $f_{c,90,xlay,k}$ is the characteristic value for compression strength perpendicular to the grain.
- $k_{c,90}$ is a factor that takes account of how the load acts and the degree of compression.
- k_{mod} is a modification factor, see section 3.1.5, page 35.
- γ_M is the partial factor for the material, see section 3.1.5, page 35.

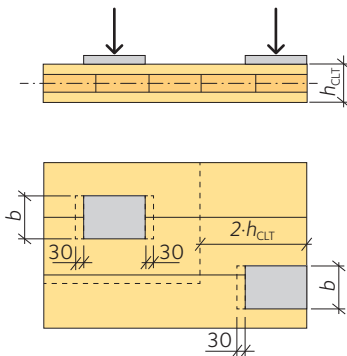

Figure 3.18 Effective contact area for compressive forces perpendicular to the CLT's plane. The edge values apply within the distance $2 h_{CLT}$ from the edge.

The effective contact area and $k_{c,90}$ factor depend on the location of the load, see figure 3.18, and work is ongoing to establish values for $k_{c,90}$.

Tests conducted to date show that the values stated in table 3.16 can be applied.

Table 3.16 Contact area A in mm^2 and b in mm plus value of $k_{c,90}$.

Location	Direction	Contact area, A_{ef}	$k_{c,90}$
Central	–	$A_{ef} = A_{tryck} + (30 + 30)b$	1.9
At edge	Parallel with grain	$A_{ef} = A_{tryck} + (30 + 30)b$	1.0 – 1.5
	Perpendicular to grain	$A_{ef} = A_{tryck} + 30b$	1.5
At corner	–	$A_{ef} = A_{tryck} + 30b$	1.3

Tests conducted to date show that the values stated in *table 3.16* can be applied.

Checking bending stress in the CLT panel’s plane

For a CLT panel or CLT slab subject to bending moment about its y -axis, see *figure 3.19*, use *equation 3.48*:

$$\sigma_{m,y,d} = \frac{M_{y,d}}{W_{x,net}} \leq f_{m,xlay,d} = k_{sys} \cdot k_{mod} \frac{f_{m,xlay,k}}{\gamma_M}$$

where:

- $M_{y,d}$ is the moment design value about the y -axis.
- $W_{x,net}$ is the panel’s net moment of resistance
- $f_{m,0,xlay,d}$ is the bending strength design value.
- $f_{m,0,xlay,k}$ is the characteristic bending strength.
- k_{sys} is a system factor, see *section 3.1.6, page 36*.
- k_{mod} is a modification factor, see *section 3.1.5, page 35*.
- γ_M is the partial factor for the material, see *section 3.1.5, page 35*.

For a panel or slab subject to bending moment about its x -axis, see *figure 3.20*, use *equation 3.49*:

$$\sigma_{m,x,d} = \frac{M_{x,d}}{W_{y,net}} \leq f_{m,ylay,d} = k_{sys} \cdot k_{mod} \frac{f_{m,ylay,k}}{\gamma_M}$$

where:

- $M_{x,d}$ is the moment design value about the x -axis.
- $W_{y,net}$ is the panel’s net moment of resistance.
- $f_{m,ylay,d}$ is the bending strength design value.
- $f_{m,ylay,k}$ is the characteristic bending strength.

Control of bending stress in a CLT wall panel or CLT beam

For a CLT wall panel or CLT beam subject to a bending moment about its z -axis, see *figure 3.21*, in the direction of the x -axis, use *equation 3.50*:

$$\sigma_{m,z,d} = \frac{M_{z,d}}{W_{z,x,net}} \leq f_{m,xlay,d} = k_{mod} \frac{f_{m,xlay,k}}{\gamma_M}$$

where:

- $M_{z,d}$ is the moment design value about the z -axis.
- $W_{z,x,net}$ is the panel’s net moment of resistance.
- $f_{m,xlay,d}$ is the bending strength design value.
- $f_{m,xlay,k}$ is the characteristic bending strength.

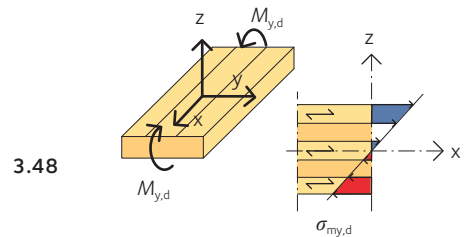

Figure 3.19 Bending stresses in CLT panel with moment about y -axis.

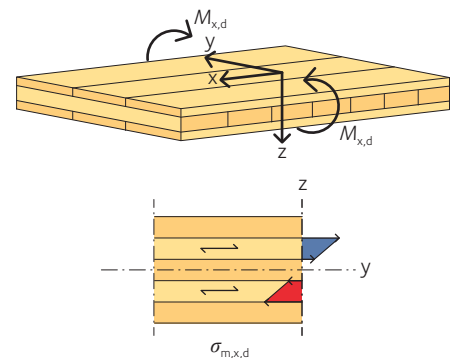

Figure 3.20 Bending stresses in CLT panel with moment about x -axis.

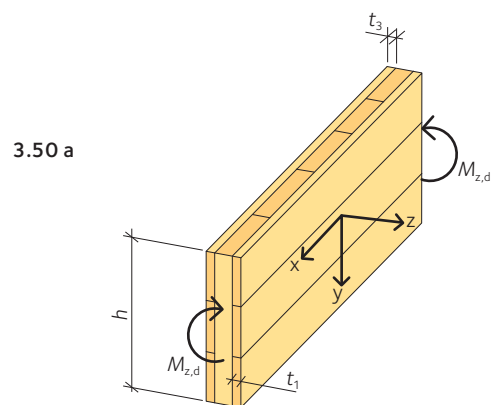

Figure 3.21 CLT panel with moment about z -axis.

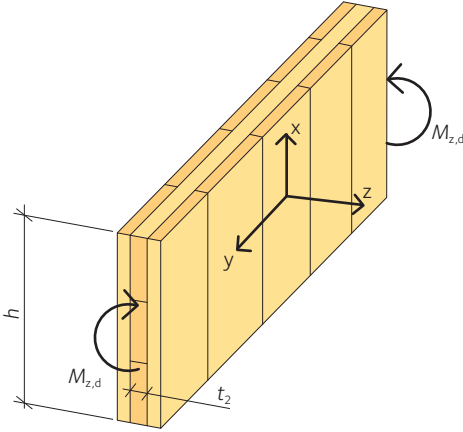

Figure 3.22 CLT panel with bending moment about z-axis.

$$3.50 \quad W_{z,x,net} = \frac{\sum t_i \cdot h^2}{6} = \frac{(t_1 + t_3 + \dots) \cdot h^2}{6}$$

where:

- t_i is the thickness of boards about the x-axis.
- h is the height of the whole CLT panel or CLT beam.

For a CLT wall panel or CLT beam subject to a bending moment about its z-axis as in figure 3.22, in the direction of the y-axis, use equation 3.51:

$$3.51 \quad \sigma_{m,z,d} = \frac{M_{z,d}}{W_{z,y,net}} \leq f_{m,y,lay,d} = k_{mod} \frac{f_{m,y,lay,k}}{\gamma_M}$$

where:

- $M_{z,d}$ is the moment design value about the z-axis.
- $W_{z,y,net}$ is the panel's net moment of resistance.
- $f_{m,y,lay,d}$ is the bending strength design value.
- $f_{m,y,lay,k}$ is the characteristic bending strength.

$$3.52 \quad W_{z,y,net} = \frac{\sum t_i h^2}{6} = \frac{(t_2 + t_4 + \dots) \cdot h^2}{6}$$

where:

- t_i is the thickness of boards along the y-axis.
- h is the height of the whole CLT panel or CLT beam.

If there is a small ratio between the CLT panel or beam's length, L , and height, h , beam theory with linear stress distribution does not apply. Deviations become noticeable from $L/h \leq 4$.

Combined bending in two directions

For CLT components used for load-bearing roofs or similar structures with no buckling risk, bending stresses may occur in the plane along the same axis, and then the strength should be verified using equation 3.53:

$$3.53 \quad \frac{\sigma_{m,y,d}}{f_{m,x,lay,d}} + \frac{\sigma_{m,z,d}}{f_{m,x,lay,d}} \leq 1$$

where:

- $\sigma_{m,y,d}$ and $\sigma_{m,z,d}$ are the bending stress design values about the main axes.
- $f_{m,x,lay,d}$ are the corresponding bending strengths.

$$3.54 \quad \frac{M_{y,d}}{W_{x,net} f_{m,x,lay,d}} + \frac{M_{z,d}}{W_{z,x,net} f_{m,x,lay,d}} \leq 1$$

where:

- $M_{y,d}$ and $M_{z,d}$ are the design values for the moment about the main axes.
- $W_{x,net}$ and $W_{z,x,net}$ are the corresponding moments of resistance.

Control of shear stress perpendicular to the plane

Shear stresses occur in CLT panels subject to shear forces perpendicular to the CLT panel. Since the CLT panel comprises longitudinal and transverse boards, both directions should be checked.

The shear strength (rolling shear strength) across the grain is often significantly lower than with the grain.

For a 5-layer CLT panel or beam subject to shear forces, $V_{xz,d}$ and $V_{yz,d}$ respectively, see figure 3.23 and figure 3.24, the following applies:

a) Verification of the shear parallel to the grain in layer 3 in figure 3.23 and layer 2 or 4 in figure 3.24:

$$\tau_{v,xz,d} = \frac{S_{x,net} \cdot V_{xz,d}}{I_{x,net} \cdot b_x} \leq f_{v,090,y,lay,d} = k_{mod} \frac{f_{v,090,y,lay,k}}{\gamma_M}$$

where:

- $V_{xz,d}$ is the design shear force.
- $S_{x,net}$ is the panel's net static moment.
- $f_{v,090,y,lay,d}$ is the design value for the longitudinal shear strength of the boards.
- $f_{v,090,y,lay,k}$ is the characteristic longitudinal shear strength of the boards.
- k_{mod} is a modification factor, see section 3.1.5, page 35.
- γ_M is the partial factor for the material, see section 3.1.5, page 35.

For a 5-layer CLT panel or beam subject to the shear force $V_{yz,d}$, see figure 3.23, the greatest shear stress is found in and around layer 3 for a symmetrical 5-layer panel, see equation 3.56. This stress must, above all, be verified against the rolling shear strength.

b) Verification of rolling shear strength (shear across the grain) in layer 2 or 4 in figure 3.23 and in layer 3 in figure 3.24:

$$\tau_{Rv,yz,d} = \frac{S_{R,y,net} \cdot V_{yz,d}}{I_{y,net} \cdot b_y} \leq f_{v,9090,x,lay,d} = k_{mod} \frac{f_{v,9090,x,lay,k}}{\gamma_M}$$

where:

- $V_{yz,d}$ is the design shear force.
- $S_{R,y,net}$ is the panel's net static moment.
- $f_{v,9090,x,lay,d}$ is the design value for the rolling shear strength of the boards.
- $f_{v,9090,x,lay,k}$ is the characteristic rolling shear strength of the boards.

When designing CLT, account does not need to be taken of splits in the CLT panels, since the structure of glued boards layered in alternating directions prevents and minimises the risk that splits will occur and spread. If a structure has a small panel width b , under certain circumstances it may need to be reduced by the factor $k_{cr} = 0,67$, using the equation $b_{ef} = k_{cr} \cdot b$.

Control of shear strength in the CLT plane

CLT panels are often used in stabilising structures. Where wind loads are absorbed by stabilising panels, for example, shear forces V_{xy} and V_{yx} occur in the CLT panel's plane. Since the CLT panels can handle loads in several directions, the strengths should be checked for the whole CLT panel (panel shear) and the constituent layers in the CLT panel (layer shear). Account must also be taken of whether the boards are glued on the edges and whether there are splits in the boards along the direction of the grain. The shear strength in the CLT panel's plane varies depending on edge gluing and split formation.

Here, the strength of CLT panels is stated without edge-glued boards or with split boards.

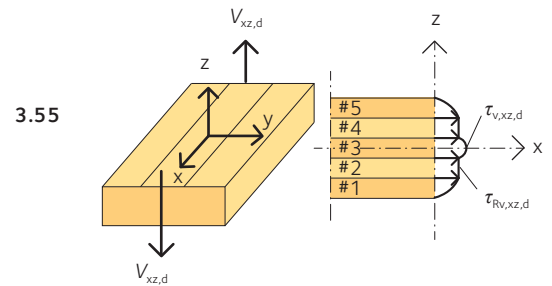

Figure 3.23 Shear stresses from shear force $V_{xz,d}$ in CLT panel.

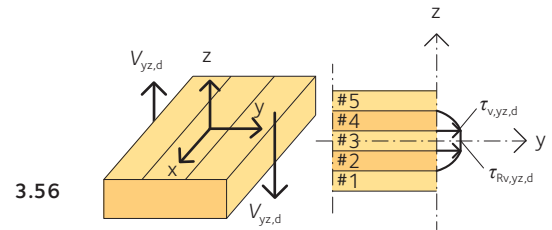

Figure 3.24 Shear stresses from shear force $V_{yz,d}$ in CLT panel.

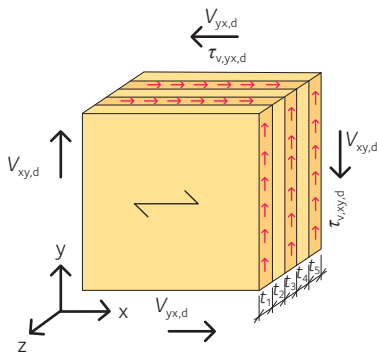

Figure 3.25 Shear stresses in relation to layer thickness in CLT panel.

When checking the whole CLT panel for panel shear, see figure 3.25, use equations 3.57 and 3.58:

$$3.57 \quad \tau_{v,xy,d} = \frac{V_{xy,d}}{A_{x,net}} \leq f_{v,090,xlay,d} = k_{mod} \frac{f_{v,090,xlay,k}}{\gamma_M}$$

where:

- $V_{xy,d}$ is the design shear force.
- $A_{x,net}$ is the panel's net area.
- $f_{v,090,xlay,d}$ is the design value for longitudinal shear strength.
- $f_{v,090,xlay,k}$ is the characteristic longitudinal shear strength.
- k_{mod} is a modification factor, see section 3.1.5, page 35.
- γ_M is the partial factor for the material, see section 3.1.5, page 35.

and:

$$3.58 \quad \tau_{v,yx,d} = \frac{V_{yx,d}}{A_{y,net}} \leq f_{v,090,ylay,d} = k_{mod} \frac{f_{v,090,ylay,k}}{\gamma_M}$$

where:

- $V_{yx,d}$ is the design shear force.
- $A_{y,net}$ is the panel's net area.
- $f_{v,090,ylay,d}$ is the design value for longitudinal shear strength.
- $f_{v,090,ylay,k}$ is the characteristic longitudinal shear strength.

Note that shear stresses in CLT panels are distributed evenly over the net cross-section and not quadratically, which is why the shear stress is calculated without the factor 1.5 that is used for rectangular cross-sections under the beam theory.

Cross-lamination of the layers means that the shear stress in relation to layer thickness is expressed in equation 3.59:

$$3.59 \quad \tau_{v,xy} \cdot h_x = \tau_{v,yx} \cdot h_y$$

with:

$$3.60 \quad h_x = \sum \frac{E_{x,i}}{E_{ref}} t_i$$

and:

$$3.61 \quad h_y = \sum \frac{E_{y,i}}{E_{ref}} t_i$$

Shear between layers, see figure 3.26, in a CLT panel is determined by the strength of the bond between the transverse and longitudinal boards. The shear stress can be expressed using equation 3.62:

$$3.62 \quad \tau_{mz,d} = \frac{M_{t,d}}{n_t \cdot W_p} \leq f_{mz,9090,d} = k_{mod} \frac{f_{mz,9090,k}}{\gamma_M}$$

where:

- $M_{t,d}$ is the moment design value.
- W_p is the board's polar moment of inertia.
- n_t is the number of bonded surfaces in the panel.
- $f_{mz,9090,d}$ is the design shear strength.
- $f_{mz,9090,k}$ is the characteristic shear strength.

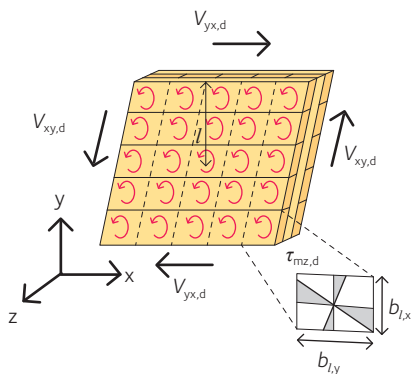

Figure 3.26 Shear stress between the layers of a CLT panel.

For example, equation 3.63 applies for a 3-layer CLT panel as in figure 3.26, page 58, for the calculation of torque in the plane:

$$M_{t,d} = V_{x,d} \cdot l \quad 3.63$$

where:

l is the distance between the roll centre and the force, $V_{x,d}$
 n_t is the number of bonded surfaces of size $b_{1,x} \cdot b_{1,y}$.

In this case $n_t = 2$ bonded layers \cdot 5 boards on x-axis \cdot 5 boards on y-axis = 50.

The polar moment of inertia can be expressed using equation 3.64:

$$W_p = \frac{2 \cdot I_p}{\sqrt{b_{1,x} b_{1,y}}} \quad 3.64$$

with:

$$I_p = I_1 + I_2 = \frac{b_{1,x} \cdot b_{1,y}^3}{12} + \frac{b_{1,x}^3 \cdot b_{1,y}}{12} \quad 3.65$$

and with $b_{1,x}$ and $b_{1,y}$ for the width of the layers on the x- and y-axis. For quadratic bonded surfaces, $b_{1,x} = b_{1,y} = b_1$, use equation 3.66:

$$I_p = \frac{b_1^4}{6} \quad 3.66$$

If the width of the boards is unknown, the width can be assumed to be 80 mm.

Checking buckling in walls and posts

The following section in this chapter shows how CLT is used as wall panels and posts, and how the lowest necessary strength can be determined in line with Eurocode 5. As with the other Eurocodes, posts are designed in Eurocode 5 with the help of linear buckling theory. Non-linear effects or the theories of other systems are taken into account in designs with the help of a strength-related reduction factor k_c . When checking buckling in CLT wall panels and posts, there are basically two different loads that can occur, pure axial compression and transverse loads, see figure 3.27. If these loads are combined, the expression using equations 3.67 and 3.68 must be met:

$$\frac{\sigma_{c,x,d}}{k_{c,y} \cdot f_{c,0,xlay,d}} + \frac{\sigma_{m,y,d}}{f_{m,xlay,d}} \leq 1 \quad 3.67$$

$$\frac{N_d}{k_{c,y} \cdot A_{x,net} \cdot f_{c,0,xlay,d}} + \frac{M_{y,d}}{W_{x,net} \cdot f_{m,xlay,d}} \leq 1 \quad 3.68$$

with:

$$M_{y,d} = \frac{q_d \cdot l_e^2}{8}$$

where the expression for the reduction factor $k_{c,y}$ can be written using equation 3.69:

$$k_{c,y} = \frac{1}{k_y + \sqrt{k_y^2 - \lambda_{rel,y}^2}} \leq 1 \quad 3.69$$

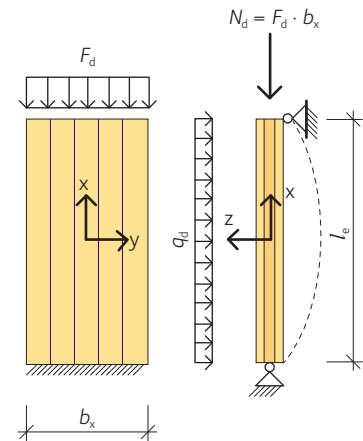

Figure 3.27 CLT wall panel subject to transverse load and compressive force.



Bridge made of glulam-trusses and roof made of CLT.

where:

$$3.70 \quad k_y = 0.5 \left(1 + 0.1 \left(\lambda_{\text{rel},y} - 0.3 \right) + \lambda_{\text{rel},y}^2 \right)$$

$$\lambda_{\text{rel},y} = \frac{\lambda_y}{\pi} \sqrt{\frac{f_{c,0,x\text{lay},k}}{E_{0,x,05}}}$$

is the relative slenderness factor for buckling about the y-axis.

$$\lambda_y = \frac{L}{i_{x,\text{ef}}}$$

is the slenderness factor and where $i_{x,\text{ef}}$ is the slenderness radius (see also section 3.3.4, page 48) and L is the buckling length.

$$E_{0,x,05} = k \cdot E_{0,x,\text{mean}}$$

with:

$$k = 1 - \frac{0.328}{\sqrt{\frac{2 \cdot b_x}{0.15} - 1}}$$

with b_x in metres and as in figure 3.27, page 59.

In cases where $\lambda_{\text{rel},y} < 0.3$ the risk of buckling is almost non-existent and then it is necessary to verify the following correlation:

$$3.71 \quad \left(\frac{\sigma_{c,x,d}}{f_{c,0,x\text{lay},d}} \right)^2 + \frac{\sigma_{m,y,d}}{f_{m,x\text{lay},d}} \leq 1$$

3.3.6 Designing in the serviceability limit state

Designing in the serviceability limit state usually includes checks on deflection, sagging and vibrations for floor slabs. In some cases, it may also be necessary to check for long term deformations. When determining the properties of the CLT slab, based on the properties of the constituent boards, there are basically four different theories:

- The Timoshenko beam theory
- The Gamma method
- The Composite method
- SAV or the Kreuzinger theory.

The differences between the methods are mainly apparent when calculating deflections in the serviceability limit state. However, all the theories deliver relatively similar results in the end. Below is a brief comparison of the different methods to calculate deformation.

Deflection calculation according to Timoshenko

A simply supported CLT floor slab can in most cases be a single-span simply supported flat strip between two or more supports.

The floor structure is subject to characteristic permanent load and characteristic variable load, considered in most cases to have a medium term duration. Deflection due to moments and shear force can be expressed using *equation 3.72*, with \bar{M} and \bar{V} as vectors for the forces according to the principle of virtual work:

$$w = \int \frac{M\bar{M}}{EI_{\text{net}}} dx + \int \frac{V\bar{V}}{GA_s} dx \quad 3.72$$

For a simply supported floor strip with free span L and distributed load q , the deflection in the mid-field can be expressed using *equation 3.73*:

$$w_{\text{mitt}} = \frac{5 \cdot qL^4}{384 \cdot EI_{\text{net}}} + \frac{qL^2}{8 \cdot GA_s} \quad 3.73$$

For a simply supported floor strip with free span L and point load P , the deflection in the mid-field can be expressed using *equation 3.74*:

$$w_{\text{mitt}} = \frac{PL^3}{48 \cdot EI_{\text{net}}} + \frac{P \cdot L}{4 \cdot GA_s} \quad 3.74$$

where:

$$EI_{\text{net}} = \sum E_i I_i + E_i A_i a_i^2 \quad 3.75$$

and:

$$GA_s = \kappa \sum G_i b_i t_i \quad 3.76$$

where κ is a shear correction factor, see *section 3.3.1 and table 3.10, page 43*.

Deflection calculation according to the Gamma method

The Gamma method is the method described in Eurocode 5 and calculation of the deflection for a beam in line with Euler-Bernoulli can be expressed using *equation 3.77*:

$$w = \int \frac{M\bar{M}}{EI_{\text{ef}}} dx \quad 3.77$$

For a simply supported floor strip with free span L and distributed load q , the deflection in the mid-field can be expressed using *equation 3.78*:

$$w_{\text{mitt}} = \frac{5 \cdot qL^4}{384 \cdot EI_{\text{ef}}} \quad 3.78$$

where E_{ef} can be calculated in line with *section 3.3.4, page 48*.

The Gamma method is a relatively well-known and widely used method, as it is presented in *Eurocode 5, annex B*. It is easy to implement manually in simple calculation programs. The method can be hard to use with slabs over multiple supports and where the CLT panel has more than five layers. Major differences in accuracy can occur.



Floor made of CLT, Ålta, Sweden.



Geschwornor house, Falun, Sweden.

Deflection calculations according to the Composite method

The deflection calculation for a beam in line with Euler-Bernoulli can be expressed using *equation 3.79*:

$$3.79 \quad w = \int \frac{M\bar{M}}{EI \cdot k_1} dx$$

For a simply supported floor strip with free span L and distributed load q , the deflection in the mid-field can be expressed using *equation 3.80*:

$$3.80 \quad w_{\text{middle}} = \frac{5 \cdot qL^4}{384 \cdot EI \cdot k_1}$$

For a simply supported floor strip with free span L and point load P , the deflection in the mid-field can be expressed using *equation 3.81*:

$$3.81 \quad w_{\text{middle}} = \frac{PL^3}{48 \cdot EI \cdot k_1}$$

with k_1 as follows:

- for a panel with two supports in the main direction of load (x-axis):

$$3.82 \quad k_1 = 1 - \left(1 - \frac{E_{90}}{E_0}\right) \cdot \frac{a_{m-2}^3 - a_{m-4}^3 + \dots \pm a_1^3}{a_m^3}$$

- for a panel with two supports in the secondary direction of load (y-axis):

$$3.83 \quad k_2 = \frac{E_{90}}{E_0} - \left(1 - \frac{E_{90}}{E_0}\right) \cdot \frac{a_{m-2}^3 - a_{m-4}^3 + \dots \pm a_1^3}{a_m^3}$$

For a 5-layer CLT panel, a_m is the thickness of the whole panel, a_{m-4} is the thickness of the middle layer and a_{m-2} is the thickness of the panel minus the thickness of the outer layers.

The method is well-known and used to design plywood structures. It is easy to implement manually in simple calculation programs. The method does not take account of shear deformations and is best suited to structures with larger spans, $L > 30 \cdot \text{CLT panel thickness}$.

Deflection calculation according to SAV or the Kreuzinger theory

This method shares many similarities with the Timoshenko beam theory. It takes account of shear deformations but depends on the shear correction factor, k .

The general calculation formula for deflection of a beam can be expressed using *equation 3.84*:

$$3.84 \quad w = \int \frac{M\bar{M}}{EI_{\text{net}}} dx + \int \frac{V\bar{V} \cdot k}{GA_{\text{ef}}} dx$$

For a simply supported floor strip with free span L and distributed load q , the deflection in the mid-field can be expressed using *equation 3.85*:

$$3.85 \quad w_{\text{middle}} = \frac{5 \cdot qL}{384EI_{\text{net}}} + \frac{qL^2 \cdot k}{8 \cdot GA_{\text{ef}}}$$

For a simply supported floor strip with free span L and point load P , the deflection in the mid-field can be expressed using *equation 3.86*:

$$w_{\text{middle}} = \frac{PL^3}{48EI_{\text{net}}} + \frac{PLk}{4 \cdot GA_{\text{ef}}}$$

with the following:

$$EI_{\text{net}} = \sum E_i I_i + E_i A_i a_i^2$$

$$GA_{\text{ef}} = \frac{b \cdot a^2}{\frac{h_1}{2G_1} + \sum_{i=2}^{n-1} \frac{h_i}{G_i} + \frac{h_n}{2G_n}}$$

with:

$$a = h_{\text{total}} - \frac{h_1}{2} - \frac{h_n}{2}$$

For rectangular cross-sections $k = 1.2$.

The method is accurate for various load cases and geometric systems and is easy to use even for CLT slabs with many layers. It is best suited to structures with spans where $L > 8 \cdot \text{CLT slab thickness}$.

3.4 CLT as two-dimensional load-bearing slabs or panels

In cases with multiple load directions, such as point support, angle support, openings, local area loads and so on, the biaxial loading effect of the panel must be considered. There are two common models, lattice (grid) and orthotropic CLT panel as presented in *section 3.4.1*. In this case, the cross-section values are stated for CLT as a shell component.

One of the most exciting properties for CLT components becomes apparent when they are used as shell components. Instead of being considered a one-dimensional structural component like a beam or post, CLT components can act in two dimensions. They can either act as a slab and take loads in different directions or as a panel and transfer shear forces and axial forces at the same time. The modelling based on stiffness values collected in a matrix makes it easier to exploit all the properties of the CLT. Designing should be based on the level of force or the load-bearing capacity, since these two-dimensional models lack the representation of internal stresses for individual layers.

3.4.1 Orthotropic slab with effective thicknesses

The effective moment of inertia in both directions $I_{x,\text{ef}}$ and $I_{y,\text{ef}}$ is determined and converted into total effective panel thicknesses $d_{x,\text{ef}}$ and $d_{y,\text{ef}}$.

$$d_{x,\text{ef}} = \sqrt[3]{\frac{12 \cdot I_{x,\text{ef}}}{100}} \quad \text{and} \quad d_{y,\text{ef}} = \sqrt[3]{\frac{12 \cdot I_{y,\text{ef}}}{100}} \quad 3.89$$

3.86

3.87

3.88



Walkway of glulam and CLT, Uppsala, Sweden.



Tiered seating made of CLT, Uppsala, Sweden.

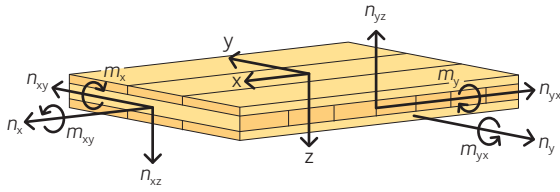

Figure 3.28 Definition of main axes and main direction for shell components.

3.4.2 Orthotropic shell with direct determination of stiffness matrix

Based on the Timoshenko beam theory with shear correction factors as set out in section 3.3.1, page 40, the stiffness values for shell components that may bend under shear force can be determined independently of the static system with cross-section values in both directions, according to Reissner-Mindlin.

Material strength for CLT shell components

The following stiffness matrix can be established for orthotropic shell components p :

$$C_{CLT} = \begin{bmatrix} D_{11} & D_{12} & 0 & 0 & 0 & 0 & 0 & 0 \\ D_{21} & D_{22} & 0 & 0 & 0 & 0 & 0 & 0 \\ 0 & 0 & D_{33} & 0 & 0 & 0 & 0 & 0 \\ 0 & 0 & 0 & D_{44} & 0 & 0 & 0 & 0 \\ 0 & 0 & 0 & 0 & D_{55} & 0 & 0 & 0 \\ 0 & 0 & 0 & 0 & 0 & D_{66} & D_{67} & 0 \\ 0 & 0 & 0 & 0 & 0 & D_{76} & D_{77} & 0 \\ 0 & 0 & 0 & 0 & 0 & 0 & 0 & D_{88} \end{bmatrix}$$

where:

$[D_{11} - D_{33}]$ describes the bending and torsion properties (CLT slab)

$[D_{44} - D_{55}]$ describes the shear stiffness properties (CLT slab)

$[D_{66} - D_{88}]$ describes the sheet stiffness properties (CLT panel)

Bending and torsion properties (CLT slab) are usually measured in kNm per meter:

$$D_{11} = \frac{E_{0,mean} \cdot I_{x,net}}{1 - \nu_{xy} \cdot \nu_{yx}} \quad \text{with} \quad \nu_{xy} = \nu_{yx} = 0$$

becomes the equation:

$$3.90 \quad D_{11} = E_{0,mean} \cdot I_{x,net}$$

$$D_{22} = \frac{E_{0,mean} \cdot I_{y,net}}{1 - \nu_{xy} \cdot \nu_{yx}} \quad \text{with} \quad \nu_{xy} = \nu_{yx} = 0$$

becomes the equation:

$$3.91 \quad D_{22} = E_{0,mean} \cdot I_{y,net}$$

$$D_{33} = k_{cr} \cdot G_{0,mean} \frac{h_{CLT}^3}{12} \quad \text{with} \quad k_{cr} = 0.65$$

becomes the equation:

$$3.92 \quad D_{33} = 0.65 \cdot G_{0,mean} \frac{h_{CLT}^3}{12}$$

$$D_{12} = D_{21} = \sqrt{\nu_{xy} \cdot \nu_{yx} \cdot D_{11} \cdot D_{22}} \quad \text{with} \quad \nu_{xy} = \nu_{yx} = 0$$

becomes the equation:

$$3.93 \quad D_{12} = D_{21} = 0$$

Note:

$$k_{cr} = \begin{cases} 0.65 & \text{for CLT with slits or splits.} \\ 0.8 & \text{for CLT without slits or splits.} \end{cases}$$

Shear stiffness properties (CLT slab) are usually measured in kN/m:

$$D_{44} = \kappa_x \cdot G_{0,\text{mean}} \cdot h_x \quad 3.94$$

$$D_{55} = \kappa_y \cdot G_{0,\text{mean}} \cdot h_y \quad 3.95$$

To calculate and view values for shear correction factors κ_x and κ_y , see section 3.3, page 40.

Sheet stiffness properties (CLT panel) are usually measured in:

$$D_{66} = E_{0,\text{mean}} \cdot h_x \quad 3.96$$

$$D_{77} = E_{0,\text{mean}} \cdot h_y \quad 3.97$$

$$D_{88} = G_{S,\text{mean}} \cdot h_{\text{CLT}} = 0,75 \cdot G_{0,\text{mean}} \cdot h_{\text{CLT}} \quad 3.98$$

$G_{S,\text{mean}}$ is the shear modulus for the whole cross-section of the CLT component, according to Silly, 2010

$$D_{67} = \nu \cdot D_{66}$$

and represents the effect of transverse expansion on longitudinal axial force, usually assuming that $\nu = 0$ and thus $D_{67} = 0$ and similarly $D_{76} = 0$.

Verifying material strength

The ratio between forces and displacements is defined in matrix form using equation 3.99 and can be used successfully in FEM calculation software:

$$\begin{Bmatrix} m_x \\ m_y \\ m_{xy} \\ n_{xz} \\ n_{yz} \\ n_x \\ n_y \\ n_{xy} \end{Bmatrix} = C_{\text{CLT}} \cdot \begin{Bmatrix} K_x = \frac{\partial \phi_y}{\partial x} \\ K_y = -\frac{\partial \phi_x}{\partial y} \\ K_{xy} = \frac{\partial \phi_y}{\partial y} - \frac{\partial \phi_x}{\partial x} \\ \gamma_{xz} = \frac{\partial u_z}{\partial x} + \phi_y \\ \gamma_{yz} = \frac{\partial u_z}{\partial y} - \phi_x \\ \epsilon_x = \frac{\partial u_x}{\partial x} \\ \epsilon_y = \frac{\partial u_y}{\partial y} \\ \gamma_{xy} = \frac{\partial u_x}{\partial y} - \frac{\partial u_y}{\partial x} \end{Bmatrix} \quad 3.99$$



CLT



Assembly of walls made of CLT, Portvaktén Växjö, Sweden.

ϕ and u represent rotation and displacement of the centre of gravity for the component's surface in directions as shown in figure 3.28, page 64.

Equation 3.99, page 65, gives both forces and deformations, and stresses in the material can be calculated on this basis.

Bending moment about x-axis and y-axis

$$m_{x,E,d} \leq m_{x,R,d}$$

$m_{x,E,d}$ is the design bending moment in kNm/m.
 $m_{x,R,d}$ is the design bending capacity in kNm/m
 and is calculated as:

$$m_{x,R,d} = W_{x,net} \cdot f_{m,xlay,d}$$

$$m_{y,E,d} \leq m_{y,R,d}$$

$m_{y,E,d}$ is the design bending moment in kNm/m.
 $m_{y,R,d}$ is the design bending capacity in kNm/m
 and is calculated as:

$$m_{y,R,d} = W_{y,net} \cdot f_{m,ylay,d}$$

Shear force in the x-z plane and the y-z plane

$$n_{xz,E,d} \leq n_{xz,R,d}$$

$n_{xz,E,d}$ is the design shear force in kN/m.
 $n_{xz,R,d}$ is the design shear capacity in kN/m
 and is calculated as:

$$n_{xz,R,d} = \frac{I_{x,net} \cdot 1 \text{ m}}{S_{R,x,net}} f_{v,9090,ylay,d}$$

$$n_{yz,E,d} \leq n_{yz,R,d}$$

$n_{yz,E,d}$ is the design shear force in kN/m.
 $n_{yz,R,d}$ is the design shear capacity in kN/m
 and is calculated as:

$$n_{yz,R,d} = \frac{I_{y,net} \cdot 1 \text{ m}}{S_{R,y,net}} f_{v,9090,xlay,d}$$

Torsional moment in the x-y plane or the y-x plane

$$m_{xy,E,d} \leq m_{xy,R,d}$$

$m_{xy,E,d}$ is the design torsional moment in kNm/m.
 $m_{xy,R,d}$ is the design torsional capacity in kNm/m
 and is calculated as:

$$m_{xy,R,d} = W_{tor,x,KLT} \cdot f_{tor,d}$$

Note: $m_{xy} = m_{yx}$ if $b_x = b_y$

Axial force along the x-axis and the y-axis

$$n_{x,E,d} \leq n_{x,R,d}$$

$n_{x,E,d}$ is the design axial force in kN/m.
 $n_{x,R,d}$ is the design axial capacity in kN/m
 and is calculated as:

$$n_{x,R,d} = A_{x,net} \cdot f_{t,xlay,d}$$

for tension and

$$n_{x,R,d} = A_{x,net} \cdot f_{c,xlay,d}$$

for compression.

$$n_{y,E,d} \leq n_{y,R,d}$$

$n_{y,E,d}$ is the design axial force in kN/m.

$n_{y,R,d}$ is the design axial capacity in kN/m and is calculated as:

$$n_{y,R,d} = A_{y,net} \cdot f_{t,ylay,d}$$

for tension and

$$n_{y,R,d} = A_{y,net} \cdot f_{c,ylay,d}$$

for compression.

Shear force in the x-y plane or the y-x plane

$$n_{xy,E,d} \leq n_{xy,R,d}$$

$n_{xy,E,d}$ is the design shear force in the CLT panel's plane in kN/m.

$n_{xy,R,d}$ is the design shear capacity in kN/m.

$$n_{xy} = n_{yx}$$

3.5 Design software for CLT

Software for CLT calculations in one dimension

In the programs, CLT components are shown as one-dimensional elements, i.e. a beam or a post. There are some calculation programs that were not developed by suppliers and some programmes developed directly by CLT manufacturers. Both types of software are based on CLT's properties as set out in the ETAs from the CLT manufacturers. With the introduction of product standard SS-EN 16351, it is possible to calculate CLT components without any ties to suppliers.

There are simple programs developed using Java or Excel, for example, that are tailored to Eurocode 5. The programs let users design CLT components in the ultimate and serviceability limit states. Methods have been implemented to conduct analyses in the serviceability limit state, in line with the methods presented in the CLT Handbook.

The programs are often built using different modules, such as a floor structure module and a wall module, where only one component is calculated at a time. Geometries and loads are stated, but they are usually restricted to the most common cases. The input data regarding such factors as number of spans, skew load distribution and point loads can have certain limitations. The type of joint is also rarely selectable and is instead always modelled as a pinned joint.

This software also lacks the option of accounting for multi-dimensional geometry with holes or skew design.



Ulls house, Uppsala, Sweden.

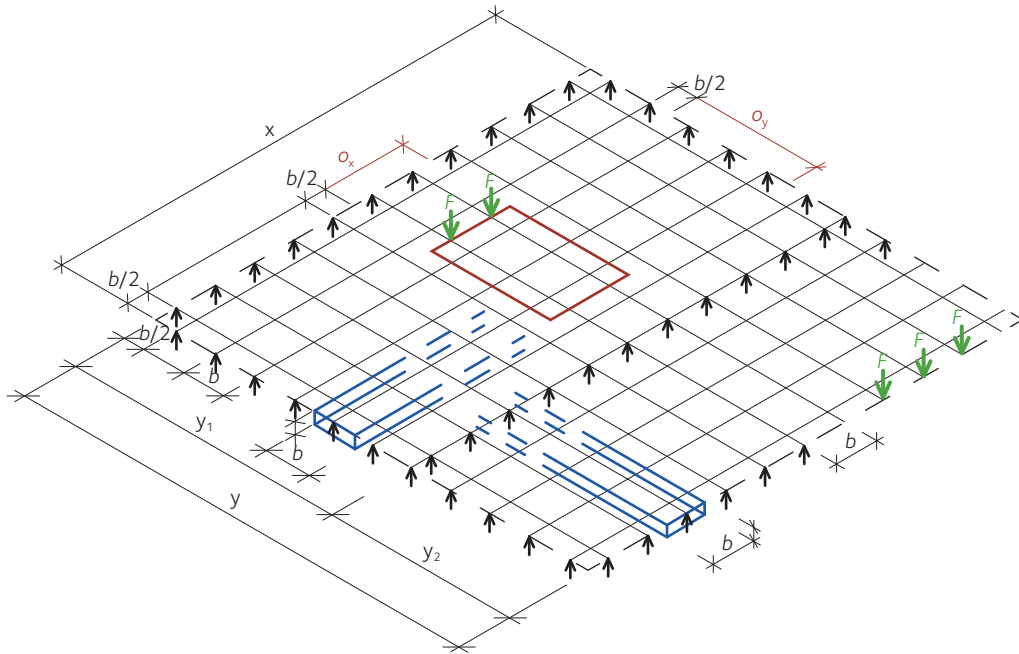

Figure 3.29 Example of a grid made up of members with different properties in different directions in a frame program.



Figure 3.30 Example of what makes up a stiffness matrix for orthotropic surfaces.

Software for CLT calculations in multiple dimensions

There are several design programs that include CLT as a selectable material. Below is some of the commercial software that is currently available and used by many CLT manufacturers and designers.

- Abaqus – General program primarily for research and education environments.
- RFEM – General program for calculations and designing a 3D environment. Regulations and requirements from Eurocodes and EKS are incorporated into the software and modules for CLT or equivalent materials are available as an add-on.
- Solid-Works – General program for calculations and design in a 3D environment.
- StatCon Structure – For designing beams and posts in line with Eurocode 5. The properties of panels from CLT manufacturers are incorporated into the software.
- StruSoft FEM-Design – General program for calculations and design in 3D.

Several CLT manufacturers have also developed their own design programs that are tailored to their own products.

3.6 Examples

3.6.1 Properties and deflection for 5-layer symmetrical CLT slab

The CLT panel made of 5 layers as in table 3.17, page 69, and figure 3.31, page 69, with a total thickness $h_{CLT} = 140$ mm. The calculation is based on a CLT slab with a width $b_x = 1.0$ m.

Table 3.17 Structure of 5-layer symmetrical CLT panel.

Layer	Direction	Thickness (mm)	Strength class
5	Long, x-axis	20	C24
4	Trans, y-axis	40	C24
3	Long, x-axis	20	C24
2	Trans, y-axis	40	C24
1	Long, x-axis	20	C24

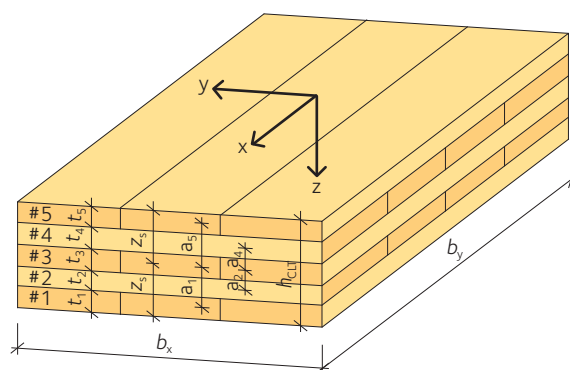
**Figure 3.31** Definition of directions and measurements.

Material values:

$E_0 = 11,000$ MPa for timber in strength class C24,

$E_{90} = 0$ MPa, $G_{090} = 650$ MPa and $G_{9090} = 50$ MPa.

Table 3.18 Properties of 5-layer symmetrical CLT panel as above. $a_1 = a_5 = 60$ mm, $a_2 = a_4 = 30$ mm, $a_3 = 0$ mm.

Property	Calculation formula	Application for example
Centre of gravity (mm)	$z_s = \frac{h_{\text{CLT}}}{2}$	$z_s = \frac{140}{2} = 70 \text{ mm}$
Net moment of inertia (mm ⁴)	$I_{x,\text{net}} = b_x \left(\frac{t_1^3}{12} + t_1 a_1^2 + \frac{t_3^3}{12} + t_3 a_3^2 + \frac{t_5^3}{12} + t_5 a_5^2 \right)$ $= b_x \left(3 \cdot \frac{t_1^3}{12} + 2 \cdot t_1 a_1^2 \right)$	$I_{x,\text{net}} = 1000 \left(3 \cdot \frac{20^3}{12} + 2 \cdot 20 \cdot 60^2 \right) = 14600 \cdot 10^4 \text{ mm}^4$
Net moment of resistance (mm ³)	$W_{x,\text{net}} = \frac{2 \cdot I_{x,\text{net}}}{h_{\text{CLT}}}$	$W_{x,\text{net}} = \frac{2 \cdot 14600 \cdot 10^4}{140} = 2086 \cdot 10^3 \text{ mm}^3$
Longitudinal shear capacity (kN)	$S_{x,\text{CLT}} = \kappa_x b_x (G_{0t_1} + G_{90t_2} + G_{0t_3} + \dots)$ $= \kappa_x b_x (3 \cdot G_{0t_1} + 2 \cdot G_{90t_2})$	$\kappa_x = 0.208 \text{ as in table 3.10, page 43}$ $S_{x,\text{CLT}} = 0.208 \cdot 1000 \cdot (3 \cdot 650 \cdot 20 + 2 \cdot 50 \cdot 40) = 8944 \text{ kN}$
Deflection at 5 kN centric point load for free span $L = 6$ m, using Timoshenko	$w_{5\text{kN}} = \frac{PL^3}{48 \cdot E_0 \cdot I_{x,\text{net}}} + \frac{P \cdot L}{4 \cdot S_{x,\text{CLT}}}$	$w_{5\text{kN}} = \frac{5 \cdot 10^3 \cdot 6000^3}{48 \cdot 11000 \cdot 14600 \cdot 10^4} +$ $\frac{5 \cdot 10^3 \cdot 6000}{4 \cdot 8944 \cdot 10^3} = 14.0 + 0.8 = 14.8 \text{ mm}$
Deflection at 3 kN/m, free span $L = 6$ m, using Timoshenko	$w_{3\text{kN/m}} = \frac{5 \cdot qL^4}{384 \cdot E_0 \cdot I_{x,\text{net}}} + \frac{qL^2}{8 \cdot S_{x,\text{CLT}}}$	$w_{3\text{kN/m}} = \frac{5 \cdot 3 \cdot 6000^4}{384 \cdot 11000 \cdot 14600 \cdot 10^4} +$ $\frac{3 \cdot 6000^2}{8 \cdot 8944 \cdot 10^3} = 31.5 + 1.5 = 33.0 \text{ mm}$
Effective moment of inertia (mm ⁴), free span $l_{\text{ref}} = 6$ m	$\gamma_1 = \gamma_5 = \frac{1}{1 + \frac{\pi^2 E_{x,i} t_i}{l_{\text{ref}}^2} \cdot \frac{t_2}{G_{9090,2}}}$ $I_{x,\text{ef}} = b_x \left(\frac{3 \cdot t_1^3}{12} + 2 \gamma_1 t_1 a_1^2 \right)$	$\gamma_1 = \gamma_5 = \frac{1}{1 + \frac{\pi^2 \cdot 11000 \cdot 20}{6000^2} \cdot \frac{40}{50}} = 0.9849$ $I_{x,\text{ef}} = 1000 \left(\frac{20^3}{4} + 2 \cdot 0.9849 \cdot 20 \cdot 60^2 \right) = 14382 \cdot 10^4 \text{ mm}^4$
Deflection at 5 kN, centric point load, free span $L = 6$ m, using Gamma method	$w_{5\text{kN}} = \frac{PL^3}{48 \cdot E_0 \cdot I_{x,\text{ef}}}$	$w_{5\text{kN}} = \frac{5 \cdot 10^3 \cdot 6000^3}{48 \cdot 11000 \cdot 14382 \cdot 10^4} = 14.2 \text{ mm}$
Deflection at 3 kN/m, free span $L = 6$ m, using Gamma method	$w_{3\text{kN/m}} = \frac{5 \cdot qL^4}{384 \cdot E_0 \cdot I_{x,\text{ef}}}$	$w_{3\text{kN/m}} = \frac{5 \cdot 3 \cdot 6000^4}{384 \cdot 11000 \cdot 15959 \cdot 10^4} = 32.0 \text{ mm}$

3.6.2 Cross-section properties for 5-layer non-symmetrical CLT panel

The CLT panel is made up of 5 layers as in table 3.19 and figure 3.32 with a total thickness $h_{CLT} = 160$ mm. The calculation is based on a CLT panel with a width $b_x = 1.0$ m.

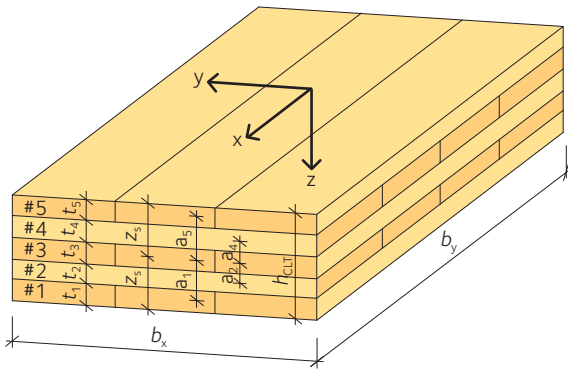

Figure 3.32 Definition of directions and measurements.

Table 3.19 Structure of 5-layer non-symmetrical CLT slab.

Layer	Direction	Thickness (mm)	Strength class
5	Long, x-axis	20	C24
4	Trans, y-axis	30	C16
3	Long, x-axis	40	C16
2	Trans, y-axis	30	C16
1	Long, x-axis	40	C24

Material values:

$E_0 = 11,000$ MPa for timber in strength class C24 = E_{ref}

$E_0 = 8,000$ MPa for C16,

$E_{90} = 0$ MPa, $G_{090} = 650$ MPa and $G_{9090} = 50$ MPa.

Calculation of centre of gravity, z_s , is conducted using values in table 3.20, where o_i is the distance from the lower edge to the centre of the layer:

$$z_s = \frac{\sum \frac{E_i}{E_{ref}} b_x t_i o_i}{\sum \frac{E_i}{E_{ref}} b_x t_i} = \frac{6428 \cdot 10^3}{89.2 \cdot 10^3} = 72.1 \text{ mm}$$

Table 3.20 Calculation of centre of gravity.

in	b_x (mm)	t_i (mm)	E_i / E_{ref}	$(E_i / E_{ref}) \cdot b_x \cdot t_i$ (mm ²)	o_i (mm)	$(E_i / E_{ref}) \cdot b_x \cdot t_i \cdot o_i$ (mm ³)
5	1,000	20	1.0	$20 \cdot 10^3$	150	$3,000 \cdot 10^3$
3	1,000	40	0.73	$29.2 \cdot 10^3$	90	$2,628 \cdot 10^3$
1	1,000	40	1.0	$40 \cdot 10^3$	20	$800 \cdot 10^3$
Total				$89.2 \cdot 10^3$		$6,428 \cdot 10^3$

Calculation of net moment of inertia, $I_{x,net}$, is conducted using values in table 3.21, where $a_i = o_i - z_s$:

$$I_{x,net} = \sum \frac{E_i}{E_{ref}} \cdot \frac{b_x \cdot t_i^3}{12} + \sum \frac{E_i}{E_{ref}} b_x t_i a_i^2 = 989 \cdot 10^4 + 23931 \cdot 10^4 = 24920 \cdot 10^4 \text{ mm}^4$$

Table 3.21 Calculation of moment of inertia.

in	b_x (mm)	t_i (mm)	E_i / E_{ref}	$(E_i / E_{ref}) \cdot (b_x \cdot t_i^3 / 12)$ (mm ⁴)	a_i (mm)	$(E_i / E_{ref}) \cdot b_x \cdot t_i \cdot a_i^2$ (mm ⁴)
5	1,000	20	1.0	$67 \cdot 10^4$	77,9	$12,137 \cdot 10^3$
3	1,000	40	0.73	$389 \cdot 10^4$	17,9	$936 \cdot 10^3$
1	1,000	40	1.0	$533 \cdot 10^4$	-52,1	$10,858 \cdot 10^3$
Total				$989 \cdot 10^4$		$23,931 \cdot 10^3$

Calculation of net moment of resistance, $W_{x,\text{net}}$, is conducted for the distances z_u and z_o for the lower and upper edges:

$$W_{x,\text{net,u}} = \frac{I_{x,\text{net}}}{z_u} = \frac{I_{x,\text{net}}}{z_s} = \frac{24920 \cdot 10^4}{72.1} = 3456 \cdot 10^3 \text{ mm}^3$$

$$W_{x,\text{net,o}} = \frac{I_{x,\text{net}}}{z_o} = \frac{I_{x,\text{net}}}{h_{\text{CLT}} - z_s} = \frac{24920 \cdot 10^4}{160 - 72.1} = 2835 \cdot 10^3 \text{ mm}^3$$



Joints and connections

- 4.1 Joints and connections 72
- 4.2 Design principles 73
- 4.3 Overview of joint types 74
 - 4.3.1 Wood screws, screws and dowels 74
 - 4.3.2 Standard metal plates and brackets 75
- 4.4 Detailed solutions 75
 - 4.4.1 Joints in the CLT plane 75
 - 4.4.2 Surface joints in the CLT plane 76
 - 4.4.3 Connections to beams 76
 - 4.4.4 Wall to wall connections 77
 - 4.4.5 Wall to floor connections 78
 - 4.4.6 Wall to foundation, wall to roof connections 79
- 4.5 Design of connections 80
 - 4.5.1 Nail and screw joints, general 80
 - 4.5.2 Designing shear resistance for self-drilling wood screws in CLT 80
 - 4.5.3 Designing withdrawal capacity for self-drilling wood screws in CLT 82
 - 4.5.4 Designing nail plates for CLT 84
 - 4.5.5 Permitted edge and centre spacing for nails, wood screws and dowels 88

Joints and their design usually have a major impact on a structure's properties. The joints affect its load-bearing capacity, stability and its properties about fire and acoustics. The design of the joints also affects the type of failure that can occur. By designing and forming the joints correctly, you can design the structure to avoid failures happening without warning. This can be achieved if the joints are designed so that the final failure is preceded by large and visible deformations caused by movement in the steel components of the joints in what is known as ductile behaviour.

The clear majority of joints in CLT structures make use of wood screws, metal plates and brackets along with anchor nails or anchor screws. The market offers a wide variety of self-drilling wood screws of various lengths that can be used directly for load-transferring joints. There is also a diverse range of standard metal plates and brackets for various purposes.

When designing wooden structures, the planners need to take several factors into account. These factors include the duration of the load, the service class and the load's direction in relation to the grain. The load direction is extra important as CLT is made up of several layers of boards in different directions. When designing wood joints, it is also vital that the structural engineer is familiar with the material's orthotropy and its hygroscopic properties.

4.1 Joints and connections

A CLT building has many different joints and connecting details. Even a simple structural frame in CLT has several different nodes that require joint solutions, see figure 4.1. Each type of joint can be designed in many ways and technical advances mean that more and more new fixings are coming onto the market. New fixings specifically for CLT are also constantly being developed. This chapter provides a brief description of the different joint types, each with a general outline of how to design such a joint. From a financial point of view, it is usually best to employ joint solutions that use fasteners and plates from the standard range.

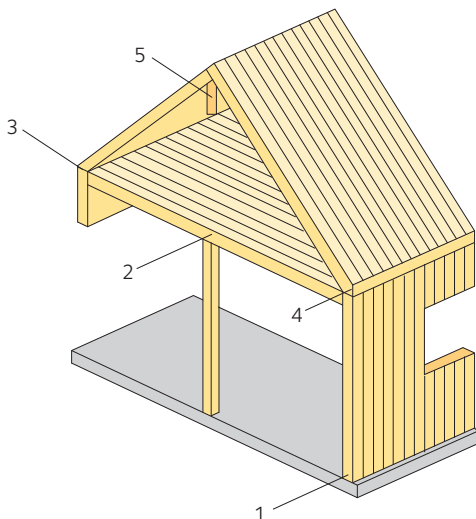

Figure 4.1 Joints in a CLT frame.
 1. Joint between wall panel and foundation.
 2. Joint between post and floor slab.
 3. Joint between wall panel and floor slab.
 4. Joint between wall panel and roof.
 5. Joint between ridge beam and roof.

4.2 Design principles

Joints tend to be a structure's weak point. It is therefore particularly important to carefully consider how a joint works statically, but also to look at the joint's effect on other functions. Joints are the load-bearing parts whose task is to connect different components of the structural structure. The structure's system lines should normally coincide with the lines for the centre of mass of the structural elements. It is also usually assumed that these meet in either rigid or pin joints.

The structural engineer must understand how the joint transfers forces and make this force transfer possible through careful design. The structural engineer's first task is to calculate the forces and moments, before the joint can be designed. These forces and moments then must be transferred by the joint, and it is essential that correct mechanical models are used in this context.

Wood is a hygroscopic material with moisture-related movement. This is a key factor to consider when designing joints so that the wood is allowed to expand and contract as humidity levels change, without internal stresses becoming too great. Since wood's tensile strength perpendicular to the grain is relatively low, the timber could split when it dries out. The moisture-related movement is small in fixings and joints for CLT and CLT tends to be used for applications where this is not a problem.

The current design rules contain the modification factors k_{mod} and k_{def} which take into account the fact that the strength decreases, and the deformation increases when the moisture content rises.

There remains a lack of supporting data and established principles for CLT in a number of the connecting situations that can occur. However, drawing on sound judgement and experience from traditional wooden structures, most cases can be resolved. A situation where there is a clear risk of peeling, for example, is when a fastener causes stress perpendicular to the grain, as shown in *figure 4.2*. When fixing into a CLT panel, the risk of a peeling failure is reduced, since the transverse layer of boards will usually spread out the tensile force. If the risk of peeling is checked using the same methods as for structural timber or glulam, the load-bearing capacity of the joint is thus underestimated.

Since CLT panels contain boards with a grain that runs in different directions (mostly with a difference of 90 degrees), it is crucial to be aware of the positioning of the fixings, so you avoid fixings in end wood or too short a fixing. The joint often causes a reduction in the design area and a weakening of the cross-section, due to the penetrating screws, inset plates and dowels.

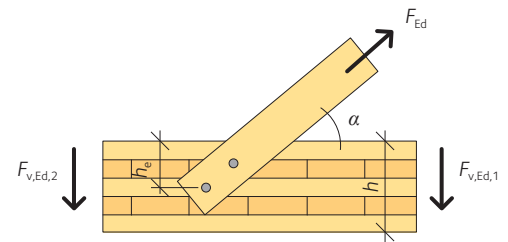

Figure 4.2 Risk of peeling caused by load perpendicular to the grain.

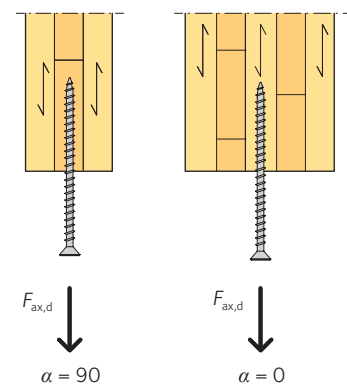

Figure 4.3 The withdrawal capacity of wood screws varies greatly, depending on whether they are positioned in a layer of boards whose grain is perpendicular to or parallel.

4.3 Overview of joint types



Roof made of glulam and CLT.

There are many different types of fixings that can be used in designing joints between CLT walls and floor slabs or joints between other materials and CLT. Long self-drilling wood screws are commonly used in joints between CLT panels but other traditional fixings such as nails, inset plates and nail plates are also widely used. There are also several more innovative solutions such as glued-in rods, advanced package solutions that cover all corner solutions, including assembly fixings and systems for invisible load-transferring joints. The new systems often rely on a high degree of prefabrication of CLT panels and the fact that CNC machines are used to design fixings.

4.3.1 Wood screws, screws and dowels

Joints using special wood screws, universal screws or wood construction screws, are simple solutions that are widely used for fastening CLT. The popularity of wood screws is due in part to their capacity to handle both shear forces and tensile forces, along with their ease of use on the construction site without pre-drilling. Self-drilling wood screws are made in diameters from 4 mm to 13 mm and in lengths of up to 1,000 mm. They are designed according to their area of use. For joints that use nail plates or other standard metal brackets, it is common to use anchor nails or anchor screws.



Anchor nail. Used in combination with metal plates.

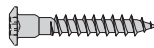

Anchor screw. Used in combination with metal plates.



Wood construction screw. With specially designed threads. No need for pre-drilling.



Universal screw. With upper and lower threads to anchor two pieces of wood.



Self-drilling dowel. Used to assemble inset steel plates in wooden structures.

Figure 4.4 Examples of nails, wood screws and dowels that are used in CLT-joints.

Screws and dowels are commonly used in large wooden structures, particularly for joints with large shear forces. When using screws and dowels in CLT structures, specific consideration must be given to the positioning, as there is a risk of the fastener being inserted into gaps between the boards when using non-edge-glued CLT panels. To transfer major shear forces, there are solutions that employ steel sleeves in the form of cylindrical rings, see figure 4.12, page 76.

4.3.2 Standard metal plates and brackets

Standard metal plates and brackets are an important type of fixing for joining floor slabs and wall panels in CLT, for example. There are all sorts of angle brackets to choose between, from brackets that handle large tensile forces to brackets that are designed to mainly transfer shear forces.

Angled nail plate

Angled nail plates can be used for joints between floor slabs and wall panels, or for abutted joints under a moderate load. They are made from hot dip galvanised or stainless steel with a thickness of 2 to 4 mm and a hole diameter of 5 mm for anchor nails or anchor screws, see figure 4.5.

Angle brackets

Angle brackets are often used for abutted joints in CLT. They can also be used to fasten CLT to concrete and are available in many dimensions for adaptation to the load in question. They are made from hot dip galvanised or stainless steel with a thickness of 2 to 3 mm and a hole diameter of 5 mm for anchor nails or anchor screws and larger holes for expansion screws, see figure 4.6.

Nail plates

Nail plates are a good option for moderate forces. Punched nail plates come in many variants. Punched plates are usually the most cost-effective alternative to drilled plates. The punching of plates requires the plate thickness not to exceed the hole diameter. The hole should be around 1 mm larger than the diameter of the fastener. The nail plates can be cast into the concrete slab or welded to cast weld plates, see figure 4.32, page 85.

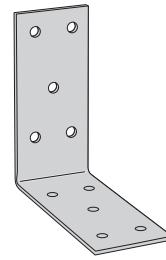

Figure 4.5 Steel Angled Bracket.

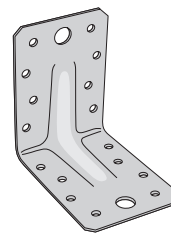

Figure 4.6 Heavy Duty Angle Bracket.

4.4 Detailed solutions

Details in the chapter show principle solutions.

4.4.1 Joints in the CLT plane

Joints between CLT panels can be executed in several different ways: joint with loose tongue, single or double cover plate, half-lap, and similar solutions. The cover plate may be plywood, LVL, planed wood or steel plate. Below is a brief description of various principles.

Joints with a loose tongue are a common solution, see figure 4.7.

The tongue can be screwed or nailed together and is a joint with two faces. The joint can also employ double tongues, which creates four faces. The joint can transfer forces along and across the CLT's plane.

Joints with double cover plates increase the capacity of the structure and the joint to transfer shear forces, see figure 4.9. The cover plates can be screwed or nailed in place and form a joint with one face per cover plate. The joint can also transfer minor moments.

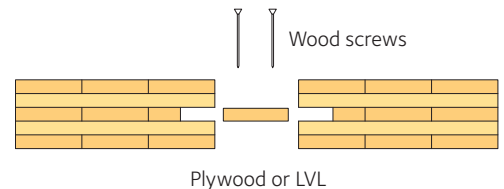

Figure 4.7 Joint with loose tongue.

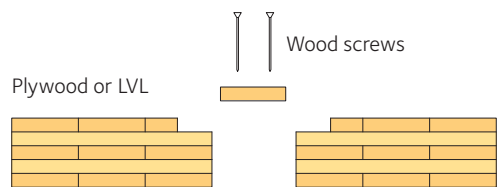

Figure 4.8 Joint with single cover plate.

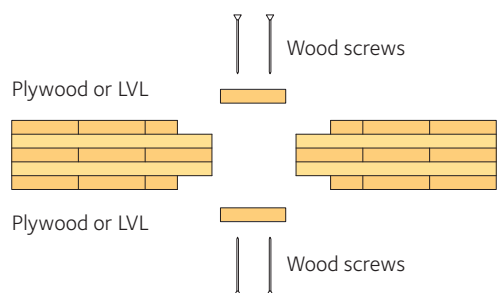

Figure 4.9 Joint with double cover plates.

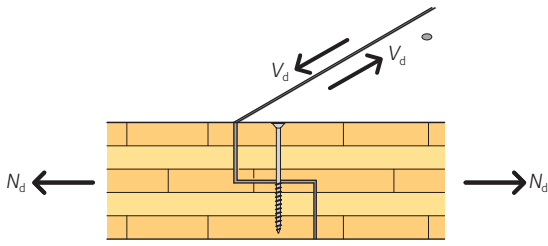

Figure 4.10 Half-lap joint.

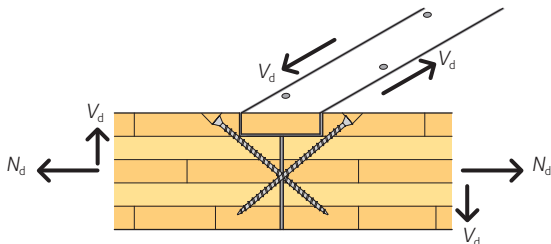

Figure 4.11 Joint with single cover plate and skew screwing.

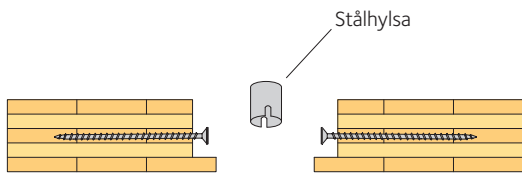

Figure 4.12 Joint with connecting steel sleeves and wood screws.

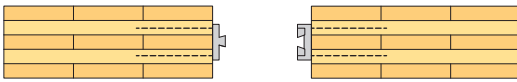

Figure 4.13 Joint with specialist fixing with skewed wood screws.

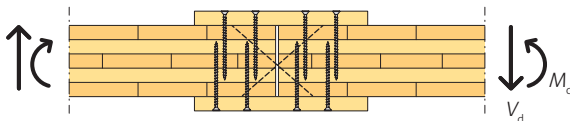

Figure 4.14 Joint in direction of main load.

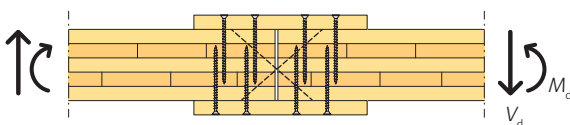

Figure 4.15 Joint perpendicular to main load.

Half-lap joints are a tried and tested method in wood construction, see figure 4.10. The simplicity of the method when combined with self-drilling wood screws makes for rapid assembly. The joint can transfer forces along and across the CLT's plane.

Joints with single cover plate and reinforcement with long self-drilling wood screws, see figure 4.11.

Joints with connecting steel sleeves together with fully threaded or glued-in screws, or wood screws, are another method that has been developed, see figure 4.12. The screws are inserted by the CLT manufacturer, so that the steel sleeve with notches can easily be fitted on the construction site. The withdrawal strength of the threaded or glued-in screws has proven to be a design factor for this type of joint. The joints can be designed for large shear forces along the length of the joint.

Joints with specialist fixings are available in various forms designed specifically for joining wooden structures, see figure 4.13. Many of the fixing systems are based on various hook systems.

The hook systems involve steel or aluminium brackets being screwed to the CLT wall panels so that the panels can then be fitted together. The number of brackets and their size determine the overall capacity of the joint.

4.4.2 Surface joints in the CLT plane

Joints along the CLT panel's plane that transfer moments to a certain degree can be achieved if cover plates are added to the top and bottom of the CLT panels, see figures 4.14 and 4.15. The cover plates can also be placed in the outermost layers of the boards, see figure 4.9, page 75. This allows smooth surfaces to be achieved but with less of a moment of resistance since the inner levers are reduced. The load-bearing capacity and stiffness of the joint also depends on the number of screws and the material chosen for the joint. With surface-mounted cover plates, around 50 percent of the forces can be transferred, as compared with non-jointed CLT panels.

4.4.3 Connections to beams

CLT panels are often used for large floor slabs, where the middle is made up of underlying or integrated beams. The design can be arranged in various ways, with a few of the possibilities presented below.

A common way to bridge gaps in the floor slab for openings and where you want smooth and even surfaces top and bottom is to set steels into the CLT structure, see figures 4.16 a) – c), page 77. To achieve smooth surfaces, the structure is built over or covered with panels of plywood or LVL. The panels can in some cases be designed to transfer compression and tensile forces along the floor slab's plane, see figures 4.16 b) – d), page 77. In cases where it can be accepted that there is no space for the joist within the thickness of the CLT panel, a very common solution is to use glulam beams, see figure 4.16 d). Glulam beams are also a frequent solution as internal support for continuous CLT panels, see figure 4.16 e), page 77.

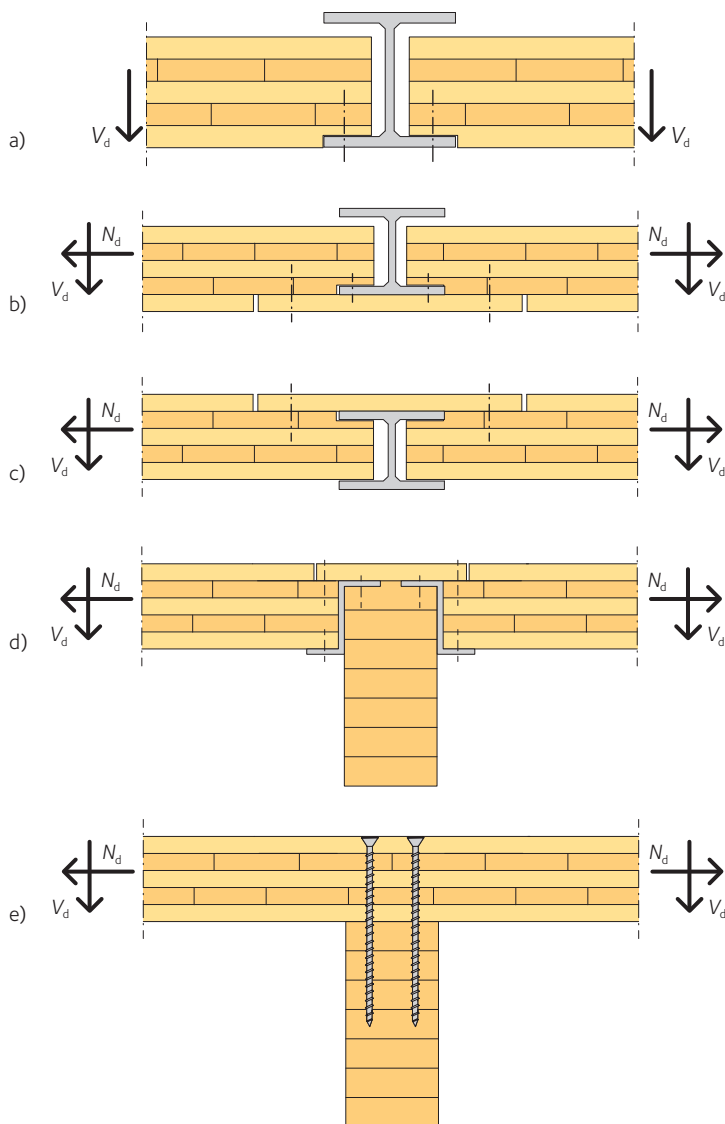

Figure 4.16 Examples of connections to beams.

4.4.4 Wall to wall connections

Wall panels can in principle be joined with wood screws, angle brackets or concealed specialist fixings. Self-drilling wood screws and angle brackets are the most common choice but there are also other, more innovative, options. Additional features may be needed to improve the joints' properties regarding fire and sound.

The simplest way of joining CLT to another wooden surface is usually to use self-drilling wood screws, see figure 4.17. It is, however, crucial to check the positioning of the screws so that they are not screwed only into end wood, i.e. parallel with the grain. To minimise the risk of this, and in cases where screwing is only possible from the side, skew screwing may be an alternative.

Another simple system is to use angle brackets or angled nail plates, see figure 4.18. This method is effective at transferring shear forces. It is, however, less suitable for exposed surfaces. The market also offers specially designed fixings, both visible and invisible.

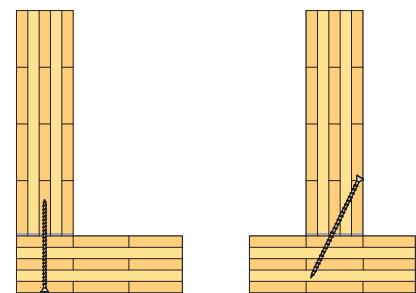

Figure 4.17 Joint using screws, horizontal cross-section.

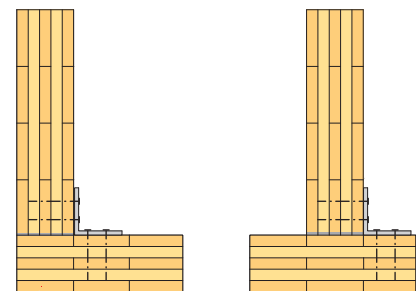

Figure 4.18 Joint using angle brackets, horizontal cross-section.

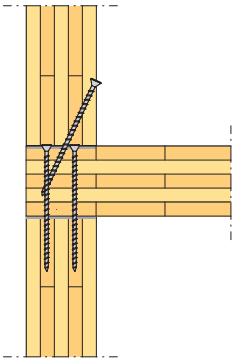

Figure 4.19 Joint between wall panel and floor slab using long wood screws.

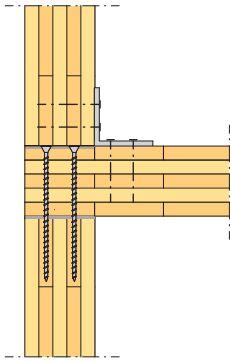

Figure 4.20 Joint between wall panel and floor slab using angle bracket.

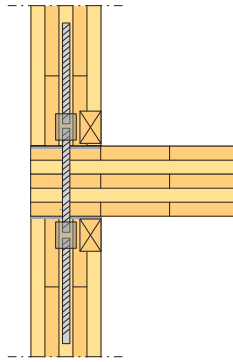

Figure 4.21 Joint between wall panels and floor slab using fully threaded screws and dowels.

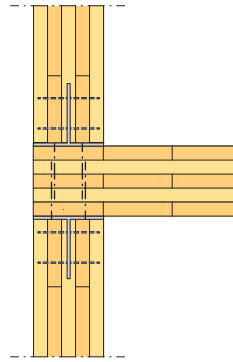

Figure 4.22 Joint between wall panels and floor slab using slotted-in steel plates.

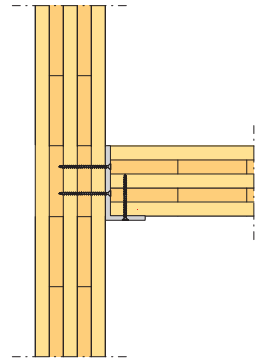

Figure 4.23 Joint between wall panel and floor slab using angle bracket.

4.4.5 Wall to floor connections

The simplest method of joining a wall panel to a floor slab is to use long self-drilling screws. These can be inserted through the floor structure above directly into the CLT panel below. The wall panel above is in turn connected with skew screwing. Instead of long wood screws, angle brackets can be used. Additions may be needed to improve the joints with regard to fire and sound.

Joints between a wall panel and a floor slab can be jointed with long self-drilling wood screws, *see figure 4.19*. The method is simple, but care must be taken not to screw into end wood and to ensure that the necessary anchoring lengths are achieved.

Joints between a wall panel and a floor slab can also be jointed with angle brackets or nail plate angled brackets, *see figure 4.20*. Angle brackets tend to be more tolerant of shear forces than screwing is. The brackets can be fixed in place using anchor nails or anchor screws.

Joints between wall panels and floor slabs can also be jointed with long or short fully threaded screws, *see figure 4.21*. Short glued-in screws in each end of the wall panel combined with thread sleeves create an assembly system that is tailored to CLT panels. Rods the length of the wall height can be used to lead forces of lift down to the foundation.

Joints between wall panels and floor slabs can also be jointed with inset fixings, *see figure 4.22*. Inset fixings, where the fixings are first screwed into the CLT, are concealed inside the wall panels and fixed in place with dowels.

Joints between wall panels and floor slabs can also be jointed with a longitudinal angle bracket, *see figure 4.23*. Alternatively, the design of the CLT slab may include underlying wood or steel studs or longitudinal timbers.

4.4.6 Wall to foundation, wall to roof connections

Wall panel connections used in CLT structures normally form non-moment-absorbing joints. The wall panel can be connected to the foundation by casting brackets into the concrete slab or welding them to fixing plates that are cast into the concrete. Alternatively, the brackets can be anchored in the concrete using expansion screws or chemical anchors. Wall ends that sit directly on concrete, brick, lightweight blocks or other hygroscopic material should be fitted with a moisture barrier.

A simple and common way to connect to the foundation is to use a nail plate or angle bracket, *see figure 4.24*. The brackets are fitted using nails or screws. This type of connection is suitable for both large and small horizontal forces. The brackets can be left exposed or concealed.

Wall panels can also be connected to the foundation using a fixed wooden guide rail, *see figure 4.25*. The CLT panel is placed on or against the guide rail and secured to it using skew screwing or some other method.

When attaching wall panels to roofs, practically all the connecting options mentioned in *section 4.4.5* can be used. The simplest form of connection and the most common is to use self-drilling wood screws, *see figure 4.26*.

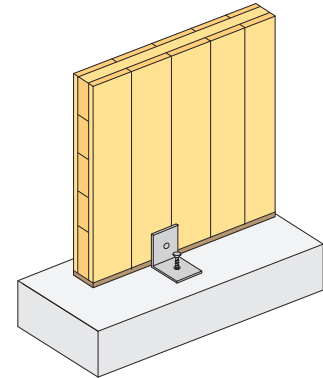

Figure 4.24 Connecting to the foundation using angle bracket.

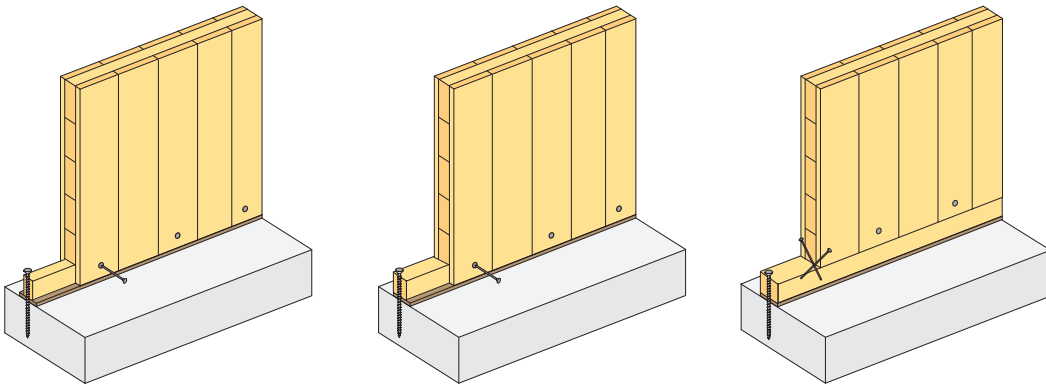

Figure 4.25 Connecting to the foundation using wooden guide rail.

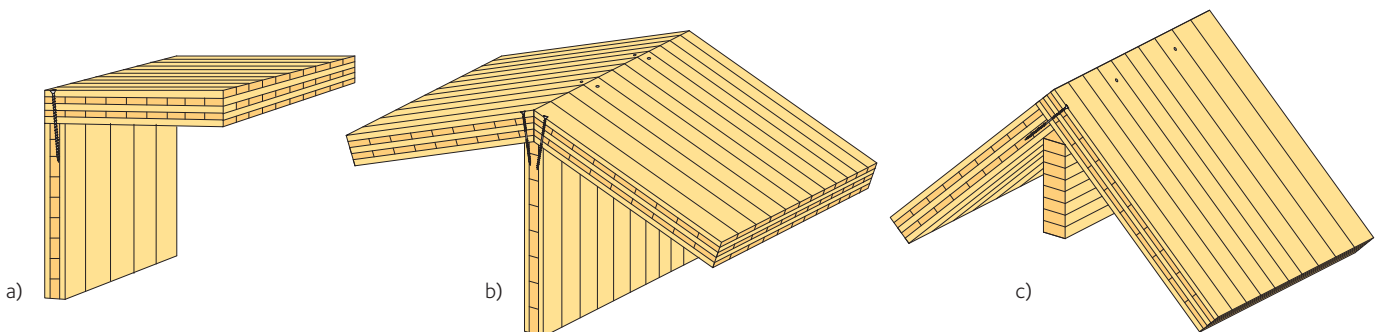

Figure 4.26 Connecting wall panel and glulam ridge beam to CLT roof.



Assembly of CLT-walls.



Screw joint, CLT.

4.5 Design of connections

4.5.1 Nail and screw joints, general

The values and methods presented in this chapter are largely based on the values and methods developed by Uibel and Blass 2006 – 2007. In most cases, manufacturers of wood screws, nails and brackets will provide their own characteristic values for their products, based on testing. Screw joints are designed according to the shear forces and tensile forces that are transferred by those joints. Compression forces are normally transferred via contact pressure between the wooden components but may also be transferred via the screw joints.

When designing joints, the following failure modes should be checked:

- Shear of the screw joint.
- Withdrawal and pull through of the wood screws.
- Interacting shear and withdrawal of the wood screws.
- Shear and tension on the wood screws (failure of steel material).
- Compression in the joint perpendicular to the grain.

The joint's load-bearing capacity is designed in line with *Eurocode 5, chapter 8.2* for shear forces and *Eurocode 5, chapter 8.7* for withdrawal forces. The interaction between shear forces and withdrawal forces is designed in line with *Eurocode 5, chapter 8.3*. The load-bearing capacity of the screw steel is checked in accordance with Eurocode 3 or with instructions from the manufacturer. Consideration must also be given to peeling and any block shear failure. If using the instructions in Eurocode 5 or *The Glulam Handbook Part 2* for this, the values you get will generally be on the safe side due to the composition of the CLT.

4.5.2 Designing shear resistance for self-drilling wood screws in CLT

CLT is unusual, compared with construction timber and glulam, since the connection takes place in a sheet with two “main directions” for the fibres. This means that account must be taken of the board layers that are being fixed into. The results of the calculations will vary depending on the structure of the layer.

Uibel and Blass have developed a couple of models for calculating characteristic embedment strength, $f_{h,k}$ perpendicular to the plane. The design models are empirical, based on several tests. Self-drilling wood screws are the most common method of connection when building with CLT. The equations stated below are based on a large number of tests with wood screws with a minimum tensile strength of $f_{u,k} = 800 \text{ N/mm}^2$. They apply to structures with predominantly static loads. Separate assessments should be carried out for dynamic loads

Shear resistance of self-drilling wood screws perpendicular to the CLT panel's plane

The shear resistance of wood screws is determined largely by the embedment strength of the CLT.

To calculate the embedment strength of a fully threaded wood screw, *equation 4.1* can be used:

$$f_{h,k} = 0.019 \cdot d^{-0.3} \cdot \rho_k^{1.24}$$

where:

- $f_{h,k}$ characteristic embedment strength.
- d the wood screw's minimum diameter in millimetres (minimum value of inner thread diameter and diameter of smooth shank).
- ρ_k characteristic dry density of wood.

The equation is valid under the following conditions:

- wood screw diameter $d \geq 6$ mm
- board thickness $t \geq 9$ mm
- the wood screw's effective length in the CLT panel must cover at least three board layers.

When calculating the load-bearing capacity of the joint, Johansen's theory under Eurocode 5 should be used. For a joint with a group of wood screws, no reduction in the number of wood screws is required. The structure of the CLT panel prevents brittle fractures and splitting. However, this assumes that a minimum distance is maintained between the wood screws.

Shear resistance of self-drilling wood screws in the CLT panel's edge

The load-bearing capacity of wood screws under a shear force in the CLT panel's edge is calculated using *equation 4.2* and is valid under the conditions stated below. It applies to wood screws perpendicular to the grain and to wood screws parallel with the grain.

$$f_{h,k} = \frac{20}{\sqrt{d_{ef}}}$$

where:

- $f_{h,k}$ characteristic embedment strength.
- d_{ef} the wood screw's minimum diameter in millimetres (minimum value of inner thread diameter and diameter of smooth shank).

The equation is valid under the following conditions:

- wood screw diameter $d \geq 8$ mm
- effective anchor length, $l_{ef} \geq 10 \cdot d$ mm
- gaps between boards < 6 mm.

When calculating the load-bearing capacity of the joint, Johansen's theory under Eurocode 5 should be used. For a joint with a group of wood screws, no reduction in the number of wood screws is required, as in *equation 4.3*. The structure of the panel prevents brittle fractures and splitting. However, this assumes that a minimum distance is maintained between the wood screws and is valid for wood screws with centre spacing $\geq 10d$. No reduction is required for centre spacing $\geq 14d$.

$$n_{ef} = n^{0.85}$$

where:

- n_{ef} is the effective no. of wood screws.
- n is the no. of wood screws that interact in the joint.

4.1

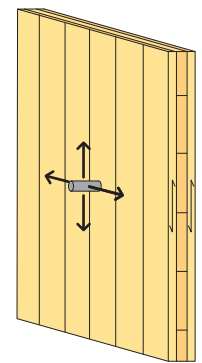

Figure 4.27 Principle for calculating embedment strength for wood screws perpendicular to the CLT panel's plane.

Table 4.1 Embedment strength, $f_{h,k}$ for certain screw diameters. Wood screw perpendicular to the panel's plane, fully threaded wood screw and wood material with characteristic density of 350 kg/m³.

Wood screw diameter d (mm)	Embedment strength, $f_{h,k}$ (N/mm ²)
6	15.8
7	15.1
8	14.5
9	14.0
10	13.6

4.2

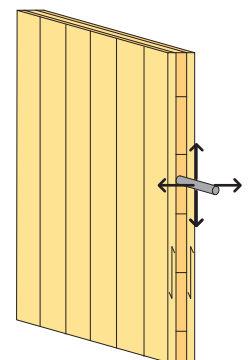

Figure 4.28 Principle for calculating embedment strength for wood screws perpendicular to the CLT panel's edges.

Table 4.2 Embedment strength, $f_{h,k}$ for certain screw diameters. Wood screw in edge of CLT panel, fully threaded wood screw and wood material with characteristic density of 350 kg/m³.

Wood screw diameter d (mm)	Embedment strength, $f_{h,k}$ (N/mm ²)
8	7.1
9	6.7
10	6.3

4.3



Transport of CLT panels at the manufacturer.

4.5.3 Designing withdrawal capacity for self-drilling wood screws in CLT

When calculating characteristic withdrawal capacity, $F_{ax,Rk}$, for self-drilling wood screws, *equation 4.4* can generally be used. *Equation 4.4* is based on test results and takes account of any gaps between the boards. The characteristic density of the wood material should amount to $\rho_k \approx 350 \text{ kg/m}^3$.

$$4.4 \quad F_{ax,Rk} = \frac{31 \cdot d^{0.8} \cdot l_{ef}^{0.9}}{1.5 \cdot \cos^2 \alpha + \sin^2 \alpha}$$

where:

- $F_{ax,Rk}$ is the characteristic withdrawal capacity.
- d is the wood screw's outer thread diameter in millimetres.
- ρ_k is the characteristic density of CLT when connecting perpendicular to the plane and the characteristic density for the relevant boards when connecting along the edge, usually $\rho_k \approx 350 \text{ kg/m}^3$.
- α is the angle between the wood screw's axis and the wood grain.
- l_{ef} is the wood screw's effective anchor length in the wood; a minimum effective anchor length of $l_{ef,min} = 4d$ is required.

The anchor length only relates to the threaded part of the wood screw:

$$4.5 \quad n_{ef} = n^{0.9}$$

where:

- n_{ef} is the effective no. of wood screws.
- n is the no. of wood screws that interact in the joint.

Withdrawal capacity of wood screws in edge

The withdrawal capacity of wood screws in the edge of CLT panels can be calculated using *equation 4.6* and applies under the stated conditions. Two different cases can occur, wood screws perpendicular to the grain and wood screws parallel with the grain.

For connections perpendicular to the grain, a conservative assumption is made, since the wood screws are not placed with any certainty in the midline of the cross-section. The factor for the wood screw's relation to the grain, α , is therefore set at zero, which gives:

$$4.6 \quad F_{ax,Rk} = \frac{31 \cdot d^{0.8} \cdot l_{ef}^{0.9}}{1.5}$$

where:

- d is the wood screw's thread diameter in millimetres.
- l_{ef} is the effective anchor length.

The equation is valid under the following conditions:

- outer thread diameter for wood screw, $d \geq 8 \text{ mm}$
- effective anchor length, $l_{ef} \geq 10 \cdot d$
- more than two wood screws per connection
- thickness of board into which screw is driven, $t \geq 3 \cdot d$
- total board thickness, $t_{tot} \geq 10 \cdot d$
- characteristic density, $\rho_k \approx 350 \text{ kg/m}^3$.

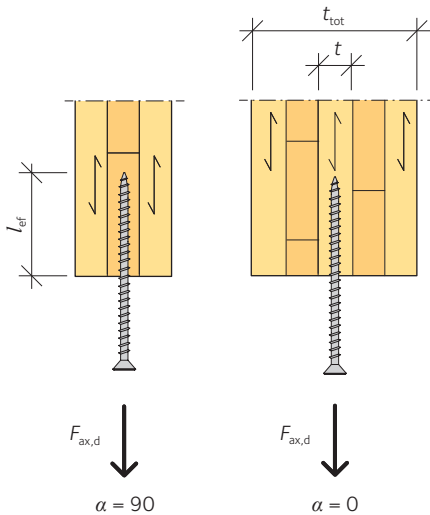

Figure 4.29 Wood screw in edge of panel, perpendicular to the grain and parallel with the grain.

Table 4.3 Characteristic withdrawal capacity, $F_{ax,Rk}$ for certain wood screw diameters and lengths. Wood screw in edge of CLT panel, anchor length as in table and wood material characteristic density of 350 kg/m^3 .

Wood screw diameter d (mm)	Anchor length, l_{ef} (mm)	Characteristic withdrawal capacity, $F_{ax,Rk}$ (kN)
8	50	3.7
8	100	6.9
10	50	4.4
10	100	8.2

Connections for load-bearing purposes that are made parallel to the grain should be avoided, as at the time of publishing *The CLT Handbook* only a few long term tests have been carried out. The suggestion is to screw within the board layer with parallel fibres, but with the wood screws angled at around 30 degrees. This means that the wood screws will cut through several fibres, which will increase the load-bearing capacity of each wood screw. The other suggestion is to reduce the characteristic withdrawal capacity when skew screwing (30-degree screw angle) by a factor of 0.5 and to insert the screws in pairs.

Tables 4.4 and 4.5 states the characteristic withdrawal capacity of skew screwed joints and the necessary correction regarding the number of pairs of wood screws. The figures in the tables are based on the assumption that the centre spacing of the wood screws is not less than $a_1 = a_2 = 5d$. The thickness of the CLT panels, t_1 and t_2 , should be greater than $10d$ and 81 respectively, see figure 4.30.

Table 4.4 Characteristic withdrawal capacity, $F_{ax,Rk}$ for skew screwed joints (30° screw angle, two screws). Wood screw in edge of CLT panel, anchor length as in table and wood material characteristic density of 350 kg/m^3 .

Wood screw diameter d (mm)	Anchor length, l_{ef} (mm)	Characteristic withdrawal capacity, $F_{ax,Rk}$ * Screw pairs 30° screw angle, reduction of 50 percent (kN)
8	50	3.7
8	100	6.9
10	50	4.4
10	100	8.2

Table 4.5 Correction factor depending on no. of skew screwed screw pairs that interact in the joint.

No. of screw pairs	1	2	4	8	12	16
Factor	1.15	1.07	1.00	0.93	0.90	0.87

If the connection is a node between transverse and longitudinal CLT panels (e.g. in a corner) or an internal wall that joints to an exterior wall panel, the ratio between the wood screw anchor lengths should be:

$$l_{ef,2} \geq 0.8l_{ef}$$

where:

$l_{ef,2}$ is the wood screw's anchor length in the transverse CLT panel.

l_{ef} is the wood screw's anchor length in the longitudinal CLT panel.



Assembly of a summer house, Skellefteå, Sweden.

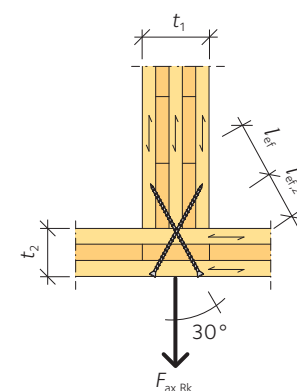

Figure 4.30 Skew screwed joint.

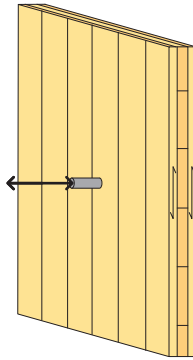

Figure 4.31 Principle for calculating withdrawal capacity for wood screws perpendicular to the CLT panel's plane.

Withdrawal capacity for wood screws perpendicular to the plane

The withdrawal capacity for wood screws placed perpendicular to the surface of the CLT panel is calculated using *equation 4.8* under the conditions stated below:

4.8
$$F_{ax,Rk} = 31 \cdot d^{0.8} \cdot l_{ef}^{0.9}$$

where:

- d is the wood screw's outer thread diameter in millimetres.
- l_{ef} is the effective anchor length.

The equation is valid under the following conditions:

- outer thread diameter for wood screw, $d \geq 6$ mm
- nominal diameter, $d_1 \geq 0.6 \cdot d$
- effective anchor length, $l_{ef} \geq 8 \cdot d$
- more than two wood screws per connection
- anchor length must cover at least 3 board layers
- total board thickness, $t_{tot} \geq 10 \cdot d$
- characteristic density, $\rho_k \approx 350$ kg/m³.

Tables 4.6 and 4.7 states the characteristic withdrawal capacity of certain wood screw types and the necessary correction regarding the number of pairs of wood screws. The figures in the tables are based on the assumption that the centre spacing of the wood screws is not less than $a_1 = a_2 = 5d$. The thickness of the CLT panels, t_1 and t_2 , should be greater than $10d$ and $8d$ respectively, see figure 4.30, page 83.

Table 4.6 Characteristic withdrawal capacity, $F_{ax,Rk}$ for certain wood screw diameters and anchor lengths. Wood screw perpendicular to plane of CLT panel, anchor length as in table and wood material characteristic density of 350 kg/m³.

Wood screw diameter d (mm)	Anchor length, l_{ef} (mm)	Characteristic withdrawal capacity, $F_{ax,Rk}$ (kN)
8	50	5.5
8	100	10.3
8	140	13.9
10	50	6.6
10	100	12.3
10	140	16.7

Table 4.7 Correction factor depending on no. of screw pairs interacting in joint.

No. of screws	2	4	8	12	16
Factor	1.07	1.00	0.93	0.90	0.87

4.5.4 Designing nail plates for CLT

Wall panels can be connected to foundations or to each other using steel plates. Plates with varying hole patterns, thicknesses and finishes can be ordered from manufacturers that sell punched plates and brackets. The price is usually lowest if the holes are punched, which means that the thickness of the metal plate must not exceed the diameter of the holes. The holes should be around 1 mm larger than the outer diameter of the fastener.

Control of steel plate

This type of joint transfers vertical compression forces via contact between the CLT panel and the foundation. The nails transfer the horizontal force $F_{E,y}$ and any vertical tensile force $F_{E,x}$ to the steel plate, which in turn channels them down to the foundation, see figure 4.32. Fixing plates cast into concrete or plates that are welded to cast weld plates are usually considered to be a fixed foundation bracket.

The following failure modes should be checked:

- shear stress in CLT
- block shear, see Eurocode 5, Appendix A
- steel plate failures caused by moment, axial force and shear force (both gross cross-section and net cross-section)
- buckling of the steel plate caused by axial force.

When checking the shear of the nailed connection, the horizontal force and any vertical tensile force are assumed to act at the nail group's centre of mass. The resulting force F_E is then as set out in equation 4.9:

$$F_E = \sqrt{F_{E,x}^2 + F_{E,y}^2}$$

To determine the number of nails, values for the capacity per fastener, $F_{v,Rd}$ are used as set out in Eurocode 5 or verified values from the manufacturer. For nails with a diameter of less than 8 mm, the load-bearing capacity is the same, whatever the direction of the force. The number of nails, n , can thus be determined using equation 4.10:

$$n = \frac{F_E}{F_{v,Rd}}$$

If the centre spacing of the nails in the direction of the grain is set at a minimum of $14d$, you do not need to limit the effective number of nails in a row, see Eurocode 5, table 8.1. If standardised nail plates are used, the distance is also determined by the whole pattern of the plate.

Block shear failure in the joint can be checked in accordance with Eurocode 5, Appendix A. If the steel plate is subject to a vertical and a horizontal force, the eccentricity of the horizontal force causes a bending moment. In the steel plate's fixed cross-section, the moment becomes:

$$M_E = F_{E,y} \cdot e_1$$

In the rows of holes with the greatest stress, the following applies:

$$M_E = F_{E,y} \cdot e_2$$

Stresses in the steel plate's different cross-sections are calculated based on the moment and the vertical and horizontal forces. If the steel plate is thin, it may be necessary to check the risk of the plate buckling. If the spacing of the fastenings in the steel plate is executed as recommended, this does not need to be checked. Therefore, the distance between the holes in the plate and between the first row of holes and the foundation should not exceed the lesser of $14t$ (t is the plate thickness) or 200 mm. The plate's connection to the foundation should also be checked.



4.9

Innovative joint solutions, X-RAD.

4.10

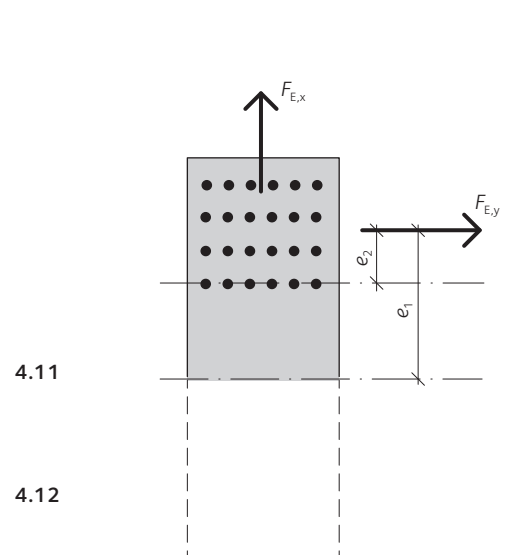

4.11

4.12

Figure 4.32 Connecting of CLT panel using steel plates. Schematic diagram. The plates can be fastened using nails or wood screws.



Supported roof of CLT, Flyinge, Lund, Sweden.

Control of steel

Steel plates are checked in line with Eurocode 3 – Design of steel structures. Various failures may occur in steel plates: tensile, compression, shear and bending failures, a combination of these and hole edge failures, although hole edge failures with standard dimensions are uncommon.

In the case of tensile failures in steel plate, the whole cross-section and the net cross-section (the part of the cross-section that remains once the holes for the fasteners have been considered) are controlled. Load-bearing capacity $N_{pl,Rd}$ for the whole cross-section can be calculated using *equation 4.13*:

$$4.13 \quad N_{pl,Rd} = \frac{f_y \cdot A}{\gamma_{M0}}$$

The load-bearing capacity $N_{u,Rd}$ for the net cross-section is:

$$4.14 \quad N_{u,Rd} = \frac{0.9 \cdot f_u \cdot A_{net}}{\gamma_{M2}}$$

$$4.15 \quad \gamma_{M2} = \max \left[1.1; 0.9 \cdot \frac{f_u}{f_y} \right]$$

where:

- f_y is the yield point for the steel material.
- f_u is the endurance limit for the steel material.
- A is the gross area of the steel plate's cross-section.
- A_{net} is the net area of the steel plate (through a row of holes).
- γ_{M0} is the partial factor for the material, here 1.0.

Compression failure in the steel plate is checked and the load-bearing capacity under stress $N_{c,Rd}$ is calculated using *equation 4.16*:

$$4.16 \quad N_{c,Rd} = \frac{f_y \cdot A}{\gamma_{M0}}$$

where:

- f_y is the yield point for the steel material.
- A is the gross area of the steel plate's cross-section.
- γ_{M0} is the partial factor for the material, here 1.0.

Buckling of the steel plate does not need to be checked if the distance between the fasteners is less than a_1 and where a_1 can be expressed:

$$4.17 \quad a_1 \leq 9t \cdot \varepsilon = 9t \sqrt{\frac{235}{f_y}}$$

where:

- f_y is the yield point for the steel material.
- t is the thickness of the steel plate.
- ε is a dimensionless factor for determining the cross-section class of the steel plate.

If the distance between the fasteners is greater than a_1 , the plate is checked by treating it as a compressed post with a buckling length of $0.6a_1$.

Bending failures in the steel plate are checked and the load-bearing capacity $M_{c,Rd}$ during bending when the cross-section is fully plastic is calculated using *equation 4.18*, for moment rotating about a centre of mass for a cross-section:

$$M_{c,Rd} = \frac{W_{pl} \cdot f_y}{\gamma_{M0}} \quad 4.18$$

where:

- W_{pl} is the plastic bending resistance of the steel plate.
- f_y is the yield point for the steel material.
- γ_{M0} is the partial factor for the material, here 1.0.

For a rectangular cross-section:

$$W_{pl} = \frac{b \cdot h^2}{4} \quad 4.19$$

where:

- h is the height of the cross-section
- b is the width of the cross-section.

The effect of the holes in the compressed zone does not need to be considered if the holes are filled with a fastener. In the tensile zone, the holes do not need to be considered as long as the following is met:

$$\frac{A_{net} \cdot 0.9 \cdot f_u}{\gamma_{M2}} \geq \frac{A \cdot f_y}{\gamma_{M0}} \quad 4.20$$

$$\gamma_{M2} = \max \left[1.1; 0.9 \cdot \frac{f_u}{f_y} \right] \quad 4.21$$

where:

- f_y is the yield point for the steel material.
- f_u is the endurance limit for the steel material.
- A is the gross area of the steel plate's cross-section.
- A_{net} is the net area of the steel plate (through a row of holes).
- γ_{M0} is the partial factor for the material, here 1.0.

Shear failure in the steel plate is checked and load-bearing capacity $V_{c,Rd}$ calculated using *equation 4.22* if the whole cross-section becomes fully plastic:

$$V_{c,Rd} = V_{pl,Rd} = \frac{A_v (f_y / \sqrt{3})}{\gamma_{M0}} \quad 4.22$$

where:

- f_y is the yield point for the steel material.
- A_v is the shear area of the steel plate's cross-section.
- γ_{M0} is the partial factor for the material, here 1.0.

The failure criterion in *equation 4.23* can be used when the steel plate is subject to simultaneous axial forces and shear force:

$$\left(\frac{\sigma_{x,Ed}}{f_y / \gamma_{M0}} \right)^2 + \left(\frac{\sigma_{y,Ed}}{f_y / \gamma_{M0}} \right)^2 - \left(\frac{\sigma_{x,Ed}}{f_y / \gamma_{M0}} \right) \left(\frac{\sigma_{y,Ed}}{f_y / \gamma_{M0}} \right) + 3 \left(\frac{\tau_{Ed}}{f_y / \gamma_{M0}} \right)^2 \leq 1 \quad 4.23$$



Staircases made of CLT.

where:

- $\sigma_{x,Ed}$ is the design value for axial stress along the length of the steel plate.
- $\sigma_{y,Ed}$ is the design value for axial stress perpendicular to the length of the steel plate.
- τ_{Ed} is the design value for shear stress.
- f_y is the yield point for the steel material.
- γ_{M0} is the partial factor for the material, here 1.0.

4.5.5 Permitted edge and centre spacing for nails, wood screws and dowels

To fully exploit the load-bearing capacity and avoid peeling, certain requirements concerning edge spacing and centre spacing between the fasteners must be met. Details of edge spacing and centre spacing can be found in *tables 4.8 – 4.11, page 89*, and *figures 4.33 – 4.34*.

The values stated assume that the grain and the direction of the force are parallel with or perpendicular to the system lines of the joint.

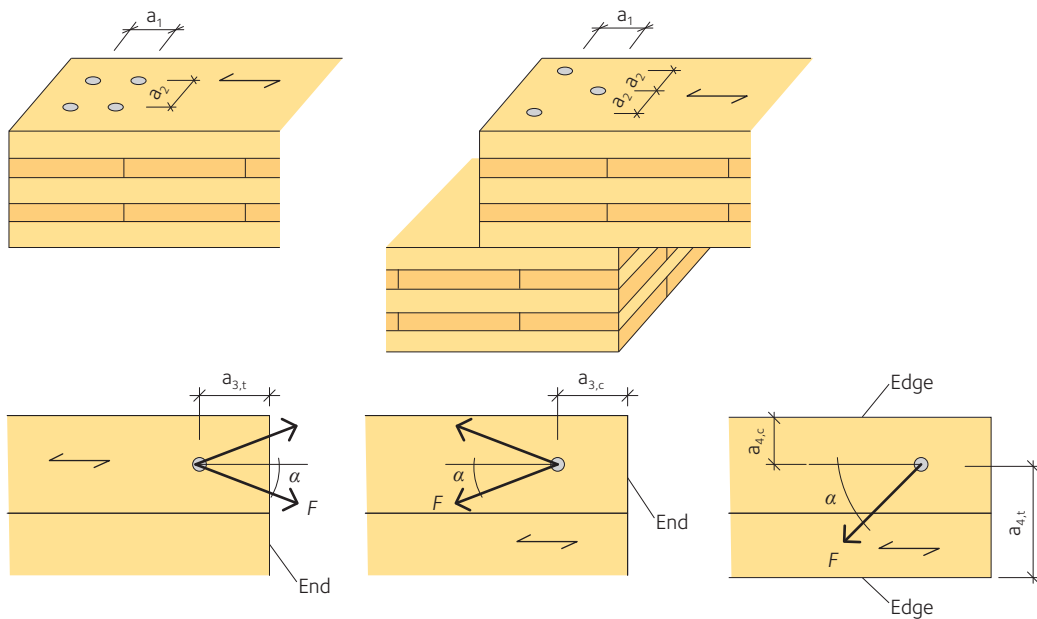

Figure 4.33 Minimum centre spacing and edge spacing for nails, wood screws and dowels in the CLT panel's plane.

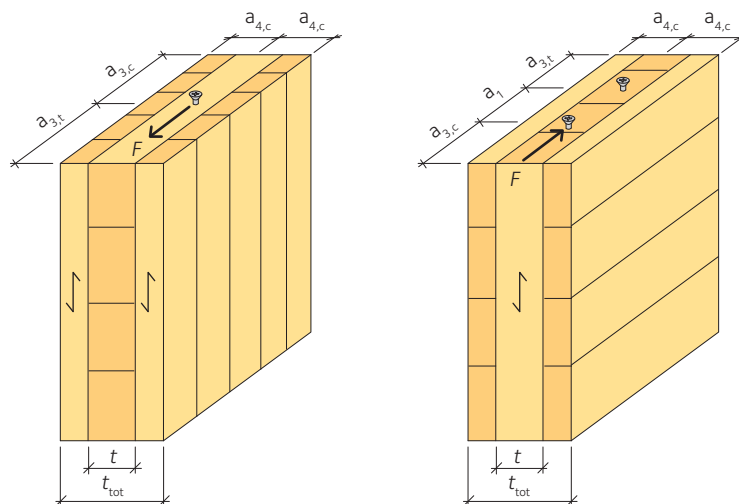

Figure 4.34 Minimum centre spacing and end/edge spacing for nails, wood screws and dowels in the CLT panel's edge.

Table 4.8 Minimum centre spacing and end/edge spacing for self-drilling wood screws in the CLT panel's plane. Wood screws with outer diameter ≥ 8 mm. See figure 4.33, page 88.

	Designation	Spacing
Centre spacing		
Parallel with grain	a_1	$4d$
Perpendicular to grain	a_2	$2.5d$
End/edge spacing		
Loaded end	$a_{3,t}$	$6d$
Unloaded end	$a_{3,c}$	$6d$
Loaded edge	$a_{4,t}$	$6d$
Unloaded edge	$a_{4,c}$	$2.5d$

Table 4.9 Minimum centre spacing and end/edge spacing for nails and dowels in the CLT panel's plane and a load parallel with the grain of the outer board layer. Designations, see table 4.8. See figure 4.33, page 88.

Fastener	a_1	a_2	$a_{3,t}$	$a_{3,c}$	$a_{4,t}$	$a_{4,c}$
Nail	$(3+3 \cos\alpha)d$	$3d$	$(7+3 \cos\alpha)d$	$6d$	$(3+3 \cos\alpha)d$	$3d$
Dowel	$(3+3 \cos\alpha)d$	$4d$	$5d$	$4d \sin\alpha$ (min. $3d$)	$3d$	$3d$

α angle between load direction and grain of outer board layer.

Table 4.10 Minimum centre spacing and end/edge spacing for self-drilling wood screws in the CLT panel's edge with outer diameter ≥ 8 mm. See figure 4.34, page 88.

	Designation	Spacing
Centre spacing		
Parallel with grain	a_1	$10d$
Perpendicular to grain	a_2	$3d$
End/edge spacing		
Loaded end, parallel with grain	$a_{3,t}$	$12d$
Unloaded end, parallel with grain	$a_{3,c}$	$7d$
Loaded edge, perpendicular to grain	$a_{4,t}$	$12d$
Unloaded edge, perpendicular to grain	$a_{4,c}$	$5d$

Table 4.11 Minimum wood thicknesses. See figure 4.34, page 88.

Fastener	Minimum thickness of loaded board layer t (mm)	Minimum total thickness t_{tot} (mm)	Minimum wood thickness and anchor length (mm)
Wood screw	$d > 8$ mm: $3d$ $d \leq 8$ mm: $2d$	$10d$	$10d$
Dowel	$8d$	$6d$	$5d$

Floor structures

- 5.1 **Floor structures – overview** 91
 - 5.1.1 Flat floor structure 91
 - 5.1.2 Cassette and hollow floor structure 92
 - 5.1.3 Composite floor structure 92
- 5.2 **Deformations** 94
 - 5.2.1 Deflection in the floor structure 94
 - 5.2.2 Load combinations 96
 - 5.2.3 Calculation methods 96
- 5.3 **Sagging and vibrations** 97
 - 5.3.1 Damping 98
 - 5.3.2 Calculation method 98
- 5.4 **Fire safety** 101
- 5.5 **Acoustic performance** 101
- 5.6 **Details** 104
- 5.7 **Example calculations** 106
 - 5.7.1 Checking floor structures 106

Floor structures and their design often have a major impact on the perception of a building and its interior environment. The design of the floor affects the whole structure's load-bearing capacity and stability, as well as its fire safety and acoustic properties. A good design will give you a floor structure that is quiet, stable and comfortable. By CLT floor structure, we mean one that is constructed almost entirely from cross laminated timber. There are various ways to construct a CLT floor structure, which can be grouped into three main categories.

- Slab floor structure
- Cassette and hollow floor structure
- Composite floor structure.

A floor structure comprises a CLT slab that, if necessary, can have cladding panels and insulation added. A cassette floor is a CLT slab with added web joists to provide extra stiffness. In a hollow floor structure, spaced web joists are sandwiched between two CLT slabs to create a hollow unit. A composite floor involves CLT slabs working in concert with a cast concrete slab. All these types are suitable for prefabrication.



Multi-storey building, Sundbyberg, Sweden.

When designing wooden structures, the planners need to take a number of factors into account. These factors include load duration, service class and the load's direction in relation to the grain, a particularly important consideration since CLT is made up of layers of boards in different directions. When designing wood joints, it is also vital that the structural engineer is well-versed in the material's orthotropy and its hygroscopic properties.

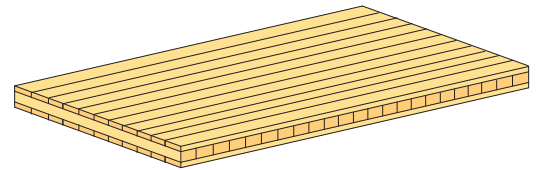

Figure 5.1 Flat floor structure.

5.1 Floor structures – overview

A floor structure is a generally horizontal load-bearing structural element that separates the different storeys of a building above and/or below it. A floor structure comprises a load-bearing part that is usually accompanied by a further separating layer and finally a surface layer in the form of carpet or wood flooring and a ceiling. The floor structure needs to be designed for horizontal and vertical loads such as self-weight, imposed load, snow load and wind load, individually or in combination. Similarly, regulatory requirements concerning deformation, sagging and vibrations must also be met. The floor structure must also be designed so that it complies with requirements concerning fire safety, sound and thermal insulation.

5.1.1 Flat floor structure

A flat floor structure in CLT is the simplest form of floor structure. The CLT panel alone takes up all the load and distributes it to the underlying structure. The composition of the panel, in terms of number and thickness of layers, is determined by the requirements for the end result. To meet sound and fire safety requirements, the CLT panel will usually have to be complemented with additional constructions on the top, bottom or sometimes both.

The cross laminated boards of the CLT slab give the floor structure high transverse stiffness with little in the way of moisture-related movement. For housing and offices, spans as set out in *table 5.1* can be expected. These values are intended for use in determining initial design values and do not offer a replacement for full calculations.

Table 5.1 Maximum permitted spans in serviceability limit state for a few different CLT floors. Stated spans meet deflection requirement $\leq L/300$ or $\leq L/600$ and deflection < 20 mm plus fundamental frequency $f_1 > -8$ Hz. Self-weight is included for subceiling and flooring totalling 25 kg/m^2 . The table applies for a simply supported floor structure and continuous floor structure over two spans in service class 1.

Design	Thickness (mm)	No. of layers	Self-weight (kg/m ²)	Maximum span (m)	
				L/300	L/600
	100	3	55	3.7	2.8
	140	5	90	4.2	3.2
	160	5	105	5.3	4.1
	100	3	55	3.9 ¹⁾	3.3
	140	5	90	4.5 ¹⁾	3.8
	160	5	105	5.2 ¹⁾	4.8

¹⁾ Sagging design factor.

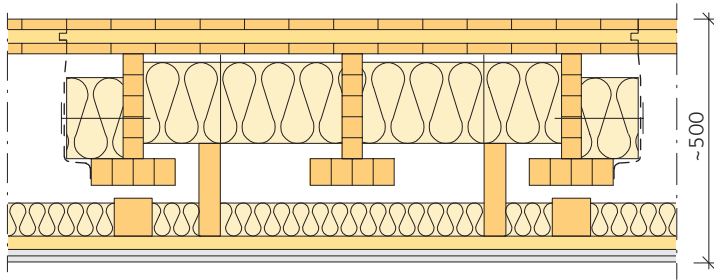

Figure 5.2 Example of a cassette floor, with CLT slab reinforced by glulam web joists and flanges plus a suspended ceiling.

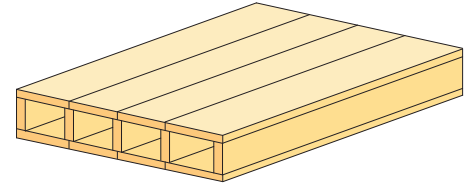

Figure 5.3 Hollow floor structure.

5.1.2 Cassette and hollow floor structure

Bonding glulam joists to the underside or top of the CLT slab enables the floor structure to handle larger loads and longer spans. The floor structure comprises a CLT slab and web joists with or without flanges. The wooden elements often must be added to in order to meet sound and fire safety requirements. The voids in the floor structure can be filled with mineral wool insulation, for example, and the underside can be fitted with a sprung suspended ceiling of plasterboard on battens. Even better acoustic solutions can be achieved if the sub ceiling can be kept entirely separate from the floor structure above. Pipes and cables can also be run through the voids.

A hollow CLT floor structure is one where the top and bottom slabs have been joined together with spaced web joists that form a void. Hollow CLT floor structures can be designed so that they can handle long spans and large loads. CLT hollow floors are not currently used to any great extent in Sweden.

5.1.3 Composite floor structure

This type of floor structure mainly comprises two parts, a CLT slab on the underside and a cast concrete slab on the top.

Usually, some form of shear connector is used to join the wood section to the concrete section and so increase the bending stiffness of the structure. From a static point of view, this type of structure is highly efficient, as you make optimum use of the materials' properties, i.e. the compressive strength of the concrete and the tensile strength of the wood. A composite floor structure has considerably higher bending stiffness than an equivalent wooden floor structure of the same height. This means that larger spans can be built when wood is used together with concrete. In addition, the dynamic properties are generally better in a composite floor structure than in an equivalent wooden floor structure, since the damping effect is often greater in the former.

Another positive aspect of this type of structure is the stiffness of the concrete slab in the floor structure's plane, which means that horizontal loads caused, for example, by wind can be spread evenly across the vertical load-bearing components such as posts and walls. The acoustics are also often better with a composite floor structure and a traditional wooden floor structure.

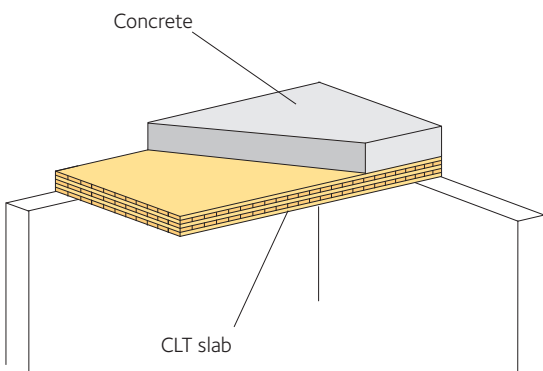

Figure 5.4 Composite floor structure in two parts, schematic.

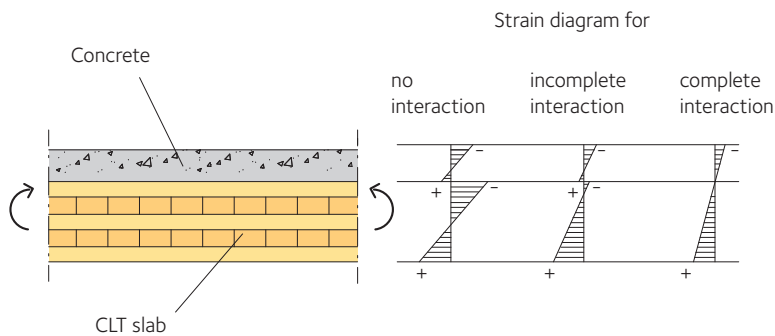

Figure 5.5 Strain diagram of composite floor structure with varying degree of interaction. The strains shown in the figure are caused only by bending moment.

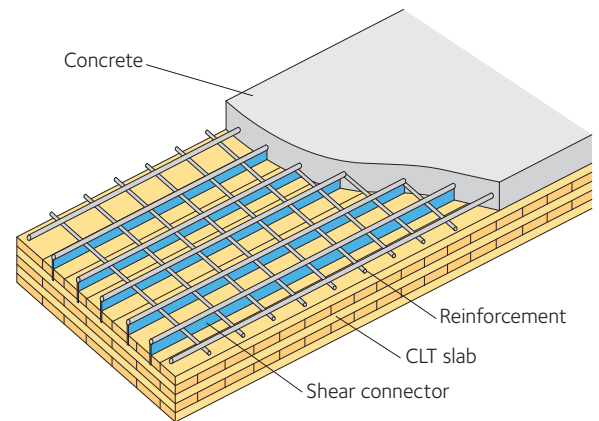

Figure 5.6 Composite floor structure in CLT and concrete, with shear connector of type HBV, Holz-Beton-Verbund.

Composite floor structure with incomplete interaction

It tends to be difficult to achieve complete interaction between wood and concrete. This section briefly describes composite components with incomplete interaction, where the transfer of shear forces between the wood and concrete parts causes more than negligible sliding in the joint. *Figure 5.4, see page 92*, shows part of a simply supported floor structure that comprises two parts, a CLT slab and a concrete slab, with incomplete interaction.

Figure 5.5 shows that in the deformed state a displacement has occurred in the joint between the component parts. This displacement varies from zero at the midspan to a peak value at the supports. This displacement generates forces in the shear connectors that join the two parts of the floor structure. If you have a sufficiently large number of shear connectors and/or choose shear connectors with extremely high shear stiffness, sliding between the wood and concrete is negligible, which means that full interaction between the materials can be assumed when designing the floor structure. On the other hand, where the number of shear connectors is very small, and their shear stiffness is low, the sliding between the two materials can occur almost unhindered, which means that no interaction at all can be assumed in designing the floor structure. In normal cases, the shear stiffness of the shear connectors is neither infinite nor zero, but somewhere in between, creating incomplete interaction, see *figure 5.5*.

The shear connectors have a critical impact on the function of the floor structure. The choice of shear connectors should be a compromise between effectiveness and economy: the shear connectors must be as stiff as possible and at the same time quick and easy to install. There are a number of shear connectors that meet these requirements to a lesser or greater extent. These include:

- Shear connector with perforated steel plate.
- Shear connector with special screws.
- Shear connector via a large notch in the top face of the CLT slab.

A shear connector of type HBV, Holz-Beton-Verbund is a special stretched net steel plate that is inserted longitudinally into the top face of the wooden component. The most common method is to have perforated steel plates bonded to the CLT slab with a polyurethane or epoxy glue, see *figure 5.6*.

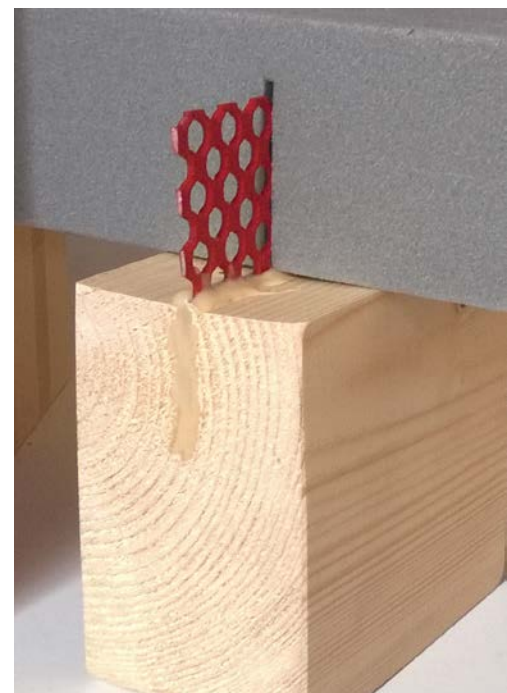

Principle of interaction between wood and concrete with shear connector of type HBV.

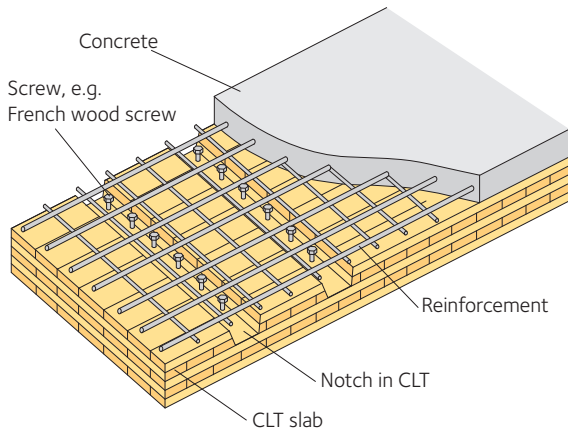

Figure 5.7 Composite floor structure in CLT and concrete, where the interaction is achieved via a notch in the upper face of the CLT slab.

Another simple way to ensure good interaction between wood and concrete is to cut a notch out of the CLT slab’s upper face. Sometimes a few screws are also screwed into the notch. The main purpose of the screws is to take up any tensile force that occurs between the sections of wood and concrete when the floor structure is put under a load, see figure 5.7.

Designing composite floor structures: principles and rules of thumb

Composite floor structures made from CLT and concrete are suitable for spans of 6 – 12 m. A preliminary value for the total cross-section height h_{tot} can be calculated as $h_{tot} \approx L/25$, where L is the span of the floor structure. The thickness of the concrete slab h_b is normally chosen as $h_b \approx 0.4 \times h_{tot}$, making the thickness of the CLT slab $h_{CLT} \approx 0.6 \times h_{tot}$. During the preliminary design of the floor structure, where checks of the dynamic properties are usually crucial, it can be assumed that the level of interaction is around 85 percent and 70 percent when using shear connectors as set out in figure 5.6, page 93 and figure 5.7 respectively.

In other words, it is assumed that the composite floor structure in question has an effective bending stiffness that is respectively around 85 % and 75 % of the bending stiffness in a corresponding floor structure that has full interaction – depending on the choice of shear connector.

Designing in the ultimate limit state is mostly done in two stages. The first stage is to calculate the cross-sectional properties and corresponding stresses in the wood and in the concrete, using the modulus of elasticity for short-term loads.

The second stage involves checking the cross-section about the materials’ long-term properties. Here account must be taken of the fact that concrete generally shrinks more than wood, which means that the load uptake mechanism in the composite floor structure changes under long-term load, with consequent “unloading” on the concrete section and corresponding “loading” on the wooden section. In other words, at any given cross-section in the floor structure and after a certain period of load, the bending stresses in the concrete reduce while the corresponding bending stresses in the wood increase. Account is taken of long-term effects by reducing the modulus of elasticity by the associated creep coefficients stated in Eurocode 2 and Eurocode 5, for concrete and wood respectively. This stage is often critical for the design in the ultimate limit state.

5.2 Deformations

5.2.1 Deflection in the floor structure

CLT that is used for apartment-separating floor structures is designed according to the prevailing national standards. The serviceability limit state is usually the design determiner for CLT floor structures under normal loads in housing and offices. The utilisation of load-bearing capacity in floor structures is usually less than 50 percent. When designing in the serviceability limit state, deformations, sagging and vibrations should be considered. The floor should be an orthotropic slab with different strength and stiffness properties in both directions.

For most designs, the load comprises a permanent component G and a variable component Q . For wooden structures, where the variable loads dominate, deflection varies during the lifetime of the structure.

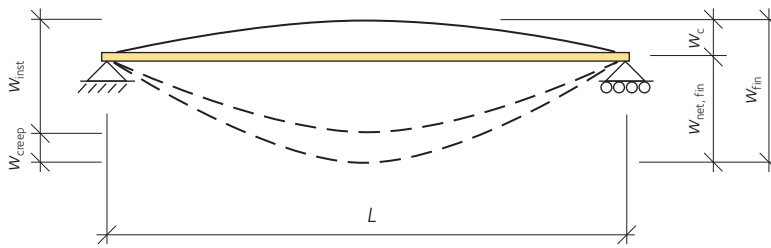

Figure 5.8 Definitions of deflection.

- W_{inst} is instantaneous deflection.
- W_{creep} is deflection caused by creep.
- W_c is any pre-camber.
- W_{fin} is final deflection.
- $W_{net,fin}$ is final net deflection.



Office building with bearing structure of CLT, Ålta, Sweden.

For a structural component subject to a constant load during its lifetime, deflection is determined based on the initial deflection, w_{inst} , the material's creep, w_{creep} , and the deformation factor, k_{def} , which is determined by the moisture content of the wood material and the variation in that moisture content.

$$w_{creep} = k_{def} w_{inst} \quad 5.1$$

The final deformation for permanent actions can thus be expressed as:

$$w_{fin,G} = w_{inst,G} + w_{creep,G} = w_{inst,G} (1 + k_{def}) \quad 5.2$$

and for variable actions:

$$w_{fin,Q_i} = w_{inst,Q_i} + w_{creep,Q_i} = w_{inst,Q_i} (1 + \psi_{2,i} k_{def}) \quad 5.3$$

Since the shrinkage (creep) depends on the length of time during which the load is active, the factor ψ_2 has been introduced to describe this effect. For floor structures, it is typical to use service class 1 ($k_{def} = 0.8$ or 0.85) and quasi-permanent values for variable actions.

A specific deflection limit can be chosen based on functional requirements or for visual reasons. Experience has shown that the deflection requirement $L/300$ ($W_{net,fin}$) is the lowest acceptable value with a small safety margin. When designing floor structures in storage spaces it is, however, often acceptable to permit deflections in the order of $L/200 - L/150$ ($W_{net,fin}$). Table 5.2 shows recommended deflection criteria.

Table 5.2 Examples of deflection limits for various load combinations.

Structural component	W_{inst}	$W_{net,fin}$	W_{fin}
Recommendations as set out in Eurocode 5			
Beam with two supports (max 20 mm)	$L/300-L/500$	$L/250-L/350$	$L/150-L/300$
Recommendations based on literature and experience			
Floor structure (max 20 mm)	$L/400-L/600$	$L/300$	$L/200-L/250$



Parking structure made of glulam and CLT, Skellefteå, Sweden.

5.2.2 Load combinations

When making deformation calculations, checks should be performed based on the loads that are expected to apply for the structure in question. For floor structures there are generally three different load combinations that may be relevant: characteristic, frequent and quasi-permanent. The load combinations usually used are expressed in equations 5.4, 5.5 and 5.6.

Characteristic combination is normally used when short-term deformations, w_{inst} , are calculated:

$$5.4 \quad \sum_{j \geq 1} G_{k,j} + Q_{k,1} + \sum_{i > 1} \psi_{0,i} Q_{k,i}$$

Frequent combination is used to estimate reversible effects:

$$5.5 \quad \sum_{j \geq 1} G_{k,j} + \psi_{1,1} Q_{k,1} + \sum_{i > 1} \psi_{2,i} Q_{k,i}$$

Quasi-permanent combination is used to determine long-term effects in the form of creep in the final deformation:

$$5.6 \quad \sum_{j \geq 1} G_{k,j} + \sum_{i \geq 1} \psi_{2,i} Q_{k,i}$$

where:

- $G_{k,j}$ are load effects of permanent actions.
- $Q_{k,1}$ is the variable leading action.
- $\psi_{0,i}, \psi_{1,1}, \psi_{2,i}$ are load combination factors.
- $Q_{k,i}$ are other variable actions.

5.2.3 Calculation methods

The deflection calculations for floor structures are performed using a number of load combinations, and in many cases, CAD makes it easier to determine the structure's deformations. The simplest method of calculating a flat plate floor structure's deflection due to self-weight and external load is to treat the slab as strips resting on two supports.

The floor slab's deflection can then be calculated using the imposed moment. If the ratio between the span, L , and the slab's thickness, h_{CLT} , is less than 10, greater account must be taken of the shear deformation.

For a floor structure that is simply supported on two supports, the deflection in the middle of the span due to bending moment can be calculated using equation 5.7:

$$5.7 \quad w_m = \frac{5 \cdot q \cdot L^4}{384 \cdot E \cdot I_{net}}$$

where:

- q is evenly distributed load.
- L is floor span.
- E is floor structure's modulus of elasticity, see section 3.3.1, page 40.
- I_{net} is floor structure's moment of inertia, see table 3.9, page 41.

The deflection of a moment-loaded floor structure or slab is obtained not only from the bending moment but also from shear forces. The proportion of the shear deformation depends on the slab's modulus of elasticity E , the panel's shear modulus G and the ratio between

the slab's thickness h_{CLT} and the span L . For CLT slabs, the ratio E/G is approximately 15 – 30 and in practice h_{CLT}/L usually falls within the range 0.02 – 0.04, which leads to a shear deformation of 5 – 20 per cent of the bending deformation. The shear deformation should be considered even for short spans.

The shear deformation's contribution w_s to the total deformation can be calculated using *equation 5.8*:

$$w_s = \frac{qL^2}{8GA_s}$$

5.3 Deflection, sagging and vibrations

Dynamic effects that occur, for example when people walk on a floor, affect our perception of the structure's quality.

The function of the floor structure is affected by a host of different factors such as the floor structure's mass, span, stiffness, load distribution and composition. CLT floor structures can be even more beneficial in contexts where the floor structures can to some extent be four-sided supported slabs that thus distribute the dynamic loads sideways, which can dampen the vibrations that arise.

Vibrations caused by people are a problem that occurs in the use phase. People walking around on a floor often tolerate greater vibrations than people who are sitting still, reading or writing. Vibrations may be felt by the person causing them, or it might be the activities of others that cause the vibrations. Vibrations can thus be separated according to the following definitions:

- Floor sagging describes the experience of a self-generated vibration or deflection in the floor caused by a single movement.
- Oscillation describes how a person perceives floor vibrations caused by other people.

Deflection is usually only a problem for light floor structures and ones that deform under a concentrated load. These floors are common in lightweight structures with a wooden frame and in other buildings with wooden floor structures. In terms of the response of a floor system, sagging involves static deflection and impulse velocity response, while disturbing oscillations involve impulse velocity response and stationary resonant response.

One method for taking vibrations into account is to verify that the structure's lowest fundamental frequency, at peak energy, is higher than the excitation frequency, i.e. avoiding the load coinciding with the response frequencies. Practically, this can be done by increasing the stiffness, reducing the mass or reducing the span. It is usually easier to increase the construction materials' ratio of strength to mass than to increase the stiffness to mass ratio.

Alternatively, the damping in the floor structure can be increased. This tends, however, to be a complex and expensive option.

It is also important to note that floor slabs can transfer vibrations between different rooms. When using continuous slabs, the vibrations are transferred from one room to another and this can be disturbing even though no problems are noticed in the room from which the vibrations originate. Vibrations from a neighbouring room are often felt to be more irritating than when the source of the vibrations is in the same room.

5.8



Roof made of glulam and CLT.



Multi-storey building, Bergen, Norway.

5.3.1 Damping

For wooden floor structures, the relative damping as set out in Eurocode 5 should be assumed to be 1 percent, unless other values have been shown to be more suitable. The relative damping for a CLT slab can therefore be estimated at around 1 percent. It is best to achieve as high a value as possible to reduce the risk of discomfort. There are relatively few studies of damping in CLT floor structures, but experience shows that the damping is probably higher for the finished floor, *see table 5.3*.

Table 5.3 Suggested values for relative damping in floor structures made from wood and CLT.

Material and composition	Relative damping
Wooden floor structure	1.0 percent
Bonded boards with cast layer	2.0 percent
Composite structure with nailed wooden joists and cast layer	3.0 percent
CLT floor structure with or without additional lightweight top layer, two-sided supported	2.5 percent
CLT floor structure with cast layer, two-sided supported	2.5 percent
CLT floor structure with cast layer, four-sided supported	3.5 percent
CLT floor structure with cast layer, four-sided supported on stud walls	4.0 percent

5.3.2 Calculation method

A CLT floor structure can be treated as a two-dimensional thin slab. In many cases, the slab’s static stiffness properties are sufficient to achieve satisfactory performance regarding to vibrations.

The key factors that determine the quality of the floor structure are the load’s frequency range and size plus the floor’s self-weight, stiffness and damping. Floor slabs in CLT usually have higher self-weight than a traditional wooden floor structure made from joists. A CLT slab can be an orthotropic slab with different stiffnesses in each load-bearing direction.

A CLT floor structure can be simply designed using beam theory. Eurocode 5 sets out a simplified method for judging a floor structure’s inclination to oscillate. This method involves calculating the static deflection for a wooden floor structure under the effect of a point load of 1 kN that simulates a footstep. The load acts in the middle of a simply supported beam and the deflection must not exceed a set value. CLT floor slabs for residential buildings can be designed and checked schematically in accordance with Eurocode 5:

- Determine the fundamental frequency. If the fundamental frequency is lower than 8 Hz a special assessment is required, but if it is higher the calculations are performed as described below.
- Determine the required quality of the floor structure by determining threshold values for *a* and *b*, *see figure 5.9*.

- Check the stiffness by calculating the deflection, w , for a point load, F , of 1 kN and compare with the recommended value in accordance with *equation 5.9*:

$$\frac{w}{F} \leq a \quad [\text{mm/kN}] \quad 5.9$$

where w is the maximum vertical instantaneous deflection of a vertical concentrated static force F .

- Check the impulse velocity response v against the chosen floor structure quality using *equation 5.10*:

$$v \leq b^{(f_1^{\zeta}-1)} \quad [\text{m}/(\text{Ns}^2)] \quad 5.10$$

where:

v is the floor structure's impulse velocity response, which can be calculated using *equation 5.15, page 100*, for a rectangular floor structure. This is the maximum vertical initial velocity in m/s due to an ideal impact of 1 Ns applied where it has the greatest effect. Vibration components over 40 Hz can be ignored.

ζ is relative damping, *see table 5.3, page 98*.

f_1 is initial fundamental frequency, which can be calculated using *equation 5.14, page 100*.

b is a factor set at 100 m/(Ns²).

The deflection criteria in this relatively basic method vary in different regulations and handbooks.

The static load that simulates force during walking is 1 kN and acts at the middle of the floor structure. The deflection, a , should not exceed a set value and the quality of the floor structure is determined based on the requirements. For Swedish conditions, Boverket has chosen the following recommendations:

$a = 1.5 \text{ mm/kN}$ and $b = 100 \text{ m}/(\text{Ns}^2)$. People are sensitive to vibrations below 8 Hz and so to avoid disturbing vibrations, the floor structure's fundamental frequency should not be lower than this value. However, vibrations over 8 Hz can also be disturbing.

The impulse velocity response is a partial indicator of how disturbing the vibrations will be. The permitted impulse velocity response depends on the floor structure's fundamental frequency and damping but should be as low as possible. Where CLT floor structures are designed for the requirements deflection $\leq L / 300$ and fundamental frequency $f_1 > 8 \text{ Hz}$, the impulse velocity response will fall within the range that is seen as positive in terms of oscillation and vibration.

Calculation of deflection

Deflection from a point load placed in the middle of a 1 m wide flat strip that is treated like a beam can be calculated using *equation 5.11*:

$$w = \frac{PL^3}{48EI_{ef}} \quad 5.11$$

where:

w is the calculated deflection for point load P .

L is the floor span.

EI_{ef} is the floor structure's bending stiffness.

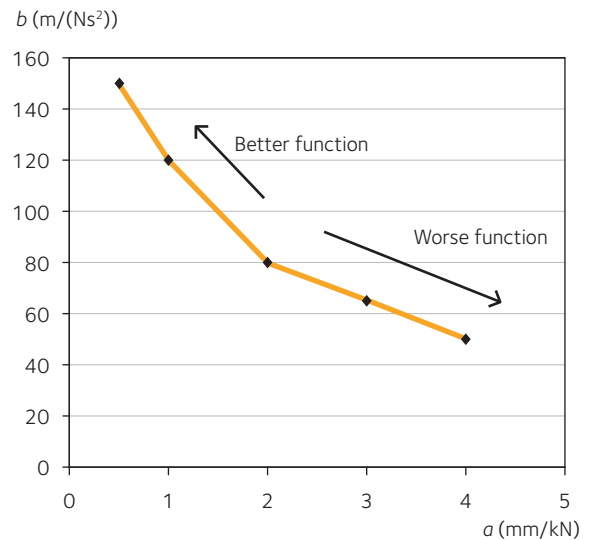

Figure 5.9 Recommended threshold values a and b and recommended correlation between a and b according to Eurocode 5.



Summer house, Skellefteå, Sweden.

Equation 5.11 gives the value for deflection for load-bearing in one direction. However, a CLT slab has two load-bearing directions and the stiffness of the floor structure in both directions can therefore be used, with the deflection determined using equation 5.12:

$$5.12 \quad w = \frac{PL^3}{48 \cdot (EI)_L \cdot B_{ef}}$$

where B_{ef} is a load distribution factor that can be calculated using equation 5.13:

$$5.13 \quad B_{ef} = \frac{L}{1.1} \sqrt{\frac{(EI)_B}{(EI)_L}}$$

where:

$(EI)_L$ is the bending stiffness in the floor structure's stiffest direction.

$(EI)_B$ is the bending stiffness perpendicular to the stiffest direction.
 L is the length in the stiffest direction.

Calculation of fundamental frequency, f_1

The lowest fundamental frequency of a floor structure that is treated as a beam is usually calculated using equation 5.14:

$$5.14 \quad f_1 = \frac{\pi}{2L^2} \sqrt{\frac{(EI)_L}{m}}$$

where:

f_1 is the lowest fundamental frequency.

L is the floor span.

$(EI)_L$ is the bending stiffness in the floor structure's stiffest direction.

m is the floor structure's mass per metre.

Calculation of impulse velocity response

For a rectangular floor structure of dimensions $B \times L$, simply supported along its four sides, v can be estimated using equation 5.15:

$$5.15 \quad v = \frac{4(0.4 + 0.6n_{40})}{mBL + 200}$$

where:

v is the impulse velocity response, [m/Ns²].

B is the floor width, [m].

L is the floor span, [m].

m is the floor structure's mass per unit of area, [kg/m²].

n_{40} is the number of first-order modes with fundamental frequencies of up to 40 Hz and calculated using:

$$5.16 \quad n_{40} = \left[\left[\left(\frac{40}{f_1} \right)^2 - 1 \right] \left(\frac{B}{L} \right)^4 \left(\frac{(EI)_L}{(EI)_B} \right) \right]^{0.25}$$

where:

$(EI)_L$ is the bending stiffness in the floor structure's stiffest direction [Nm²/m].

$(EI)_B$ is the bending stiffness perpendicular to the stiffest direction [Nm²/m], $(EI)_B < (EI)_L$.

5.4 Fire safety

To achieve the desired fire resistance classification, it is important to choose and assemble the materials correctly. Different fire resistance classifications can be obtained by adding plasterboard or a suspended ceiling and/or flooring as a complement to the floor structure. There are several ceiling designs, which can be heavy, light, insulating and/or absorbent. The ceilings can be rigidly fixed, suspended on sprung fixings or self-supporting. Housing usually has fixed ceilings that cannot be opened. They usually comprise one or two layers of plasterboard over battens and insulation. They can either be built on site or delivered pre-fabricated. They have a load-bearing frame that is often filled with insulation and parts of the installations can be pre-assembled. Delivery to the construction site should coincide with delivery of the floor structure. In housing, the ceiling is sometimes self-supporting since the spans are smaller and the internal walls can be used as supports.

Floor structures made from CLT slabs with or without additional cladding on the underside lose their load-bearing capacity at different times when exposed to fire. The floor structure's remaining load-bearing capacity is determined by the remaining effective cross-section, h_{eff} . The effective cross-section is determined by the way the layer of charcoal, d_{char} , develops and the non-load-bearing layer beneath the charcoal, d_0 .

Chapter 7, *CLT and fire*, see page 133, presents underlying data for calculations of several different cross-sectional constructions.

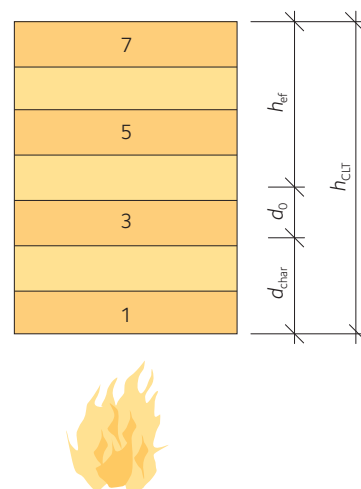

Figure 5.10 Effective cross-section, h_{eff} , charcoal layer, d_{char} , and non-load-bearing layer, d_0 for a cross-section subjected to fire.

5.5 Acoustic performance

To achieve the required acoustic performance, it is important to choose and assemble the materials correctly. Sub ceilings are used to improve sound insulation between different parts of a building, but also to hide installations for electricity, ventilation, water and sewerage. Different acoustic requirements can be met by adding plasterboard, a sub ceiling and/or flooring as a complement to the floor structure.

A flooring layer can be added in the form of joists and boarding or using concrete. The choice depends on the requirements that must be met. Generally, the concrete option is not as thick, while the floor structure's self-weight is higher. Both options can be used in residential and office buildings. To help with the choice, which really comes down to the context, you simply must weigh up the pros and cons of each option.

There are many different types of ceiling, which can be heavy, light, insulating and/or absorbent. The ceilings can be rigidly fixed, suspended on sprung fixings or self-supporting. Self-supporting ceilings provide the best sound insulation. A sprung suspended ceiling offers acceptable sound insulation, but it is not as good as a self-supporting ceiling. However, in office environments for example, a suspended ceiling may be preferable due to the long spans.

Housing usually has heavier, fixed ceilings that cannot be opened. They usually comprise one or two layers of plasterboard over battens and insulation. They can either be built on site or delivered as pre-fabricated surface units.

In housing, the surface units are normally self-supporting since the spans are smaller and the internal walls can be used as supports for the units. From the time of assembly until the internal walls are erected, the surface units rest on temporary supports, known as props.

Office blocks tend to have lightweight, openable suspended ceilings that are fitted on site once all the cables and pipes have been installed above. These ceilings are usually only absorbent, but types that are both absorbent and insulating do exist. Table 5.4 presents the sound values for certain designs of ceiling and/or flooring combined with a flat plate floor structure. *L* is the impact sound level and *D* is the airborne sound insulation. The ideal is to have as low a value as possible for impact sound level and as high a value as possible for airborne sound insulation. The sound levels are given in dB and the values in brackets relate to the adaptation values $C_{1,50-2500}$ and $C_{50-3150}$. See also table 8.14, page 153.

Table 5.4 Acoustic performance for different types of floor structure with CLT slabs. The table also shows which sound insulation classes (A–D) can be expected for various floor structure designs. The values and classes should be considered as approximate and further additions may be required in order to achieve them. Contributions from flanking transmission must also be considered.

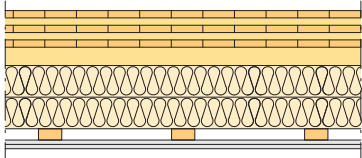
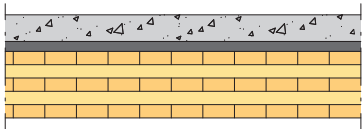
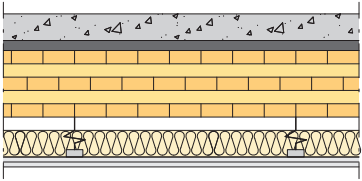
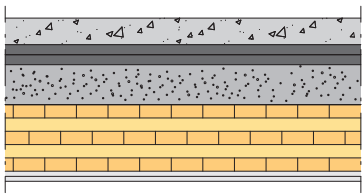
Floor structure type	Material (mm)	Total height (mm)	Weight (kg/m ²)	Vertical sound insulation (dB)	
				Impact sound level, <i>L</i>	Airborne sound insulation, <i>D</i>
	Floor structure type 1 110 CLT slab 220 fixed joists 2 × 95 insulation 34 battens 2 × 13 plasterboard	390	92	63 (+7)	56 (-6)
		Residential houses sound insulation class ²⁾		–	D
		Offices sound insulation class ³⁾		A	A
	Floor structure type 2 80 concrete 30 impact sound insulation, dynamic stiffness ≤: 9 MN/m ³ 200 CLT slab	310	266	52 (+5)	63 (-8)
		Residential houses sound insulation class ²⁾		C	C
		Offices sound insulation class ³⁾		A	A
	Floor structure type 3 80 concrete 30 impact insulation, dynamic stiffness ≤: 9 MN/m ³ 200 mm CLT slab 120 suspended ceiling joists 80 insulation 2 × 15 plasterboard, density ≥ 1050 kg/m ³	460	207	33 (+17)	79 (-14)
		Residential houses sound insulation class ²⁾		B	A
		Offices sound insulation class ³⁾		A	A
	Floor structure type 4 80 concrete 30 mm impact insulation, dynamic stiffness ≤: 12 MN/m ³ 30 mm impact insulation, dynamic stiffness ≤: 12 MN/m ³ 120 washed gravel 200 CLT slab 2 × 15 plasterboard, density ≥ 1050 kg/m ³	460	450	40 (+4)	75 (-7)
		Residential houses sound insulation class ²⁾		A	A
		Offices sound insulation class ³⁾		A	A

¹⁾ Value not available.

²⁾ Space outside home to space inside home.

³⁾ From space to space for private work or conversations.

Cont >>>

Cont >>>

Floor structure type	Material (mm)	Total height (mm)	Weight (kg/m ²)	Vertical sound insulation (dB)	
				Impact sound level, <i>L</i>	Airborne sound insulation, <i>D</i>
	Floor structure type 5 13 mm plasterboard, floating 3 foam 200 CLT slab 50 heavy insulation, density ≥ 100 kg/m ³	266	130	64	¹⁾
		Residential houses sound insulation class ²⁾		–	–
		Offices sound insulation class ³⁾		B	–
	Floor structure type 6 CLT slab 50 heavy insulation, density ≥ 100 kg/m ³	250	106	68	¹⁾
		Residential houses sound insulation class ²⁾		–	–
		Not suitable for offices		–	–
	Floor structure type 7 14 wood flooring 3 foam 22 fibreboard, floating 12 impact insulation, damping 4 dB 13 plasterboard, screwed 200 CLT slab 50 heavy insulation, density ≥ 100 kg/m ³	334	160	60	¹⁾
		Residential houses sound insulation class ²⁾		–	–
		Offices sound insulation class ³⁾		B	–
	Floor structure type 8 14 wood flooring 3 foam 22 fibreboard, floating 20 impact insulation, damping 4 dB 22 fibreboard 95 floor joists 95 insulation 25 sylodyn 200 mm CLT slab	401	145	54 (+6)	52 (-4)
		Residential houses sound insulation class ²⁾		D	D
		Offices sound insulation class ³⁾		B	B
	Floor structure type 9 14 wood flooring 3 foam 13 plasterboard 22 fibreboard 20 impact insulation 80 washed gravel, 8-11 mm 200 CLT slab	352	235	44 (+6)	63 (-1)
		Residential houses sound insulation class ²⁾		B	A
		Offices sound insulation class ³⁾		A	A
	Floor structure type 10 14 wood flooring 2x13 plasterboard 22 fibreboard beams with struts 200 insulation 130 CLT slab 13 plasterboard	413	130	56	52
		Residential houses sound insulation class ²⁾		C	C
		Offices sound insulation class ³⁾		A	A
	Floor structure type 11 14 wood flooring 2x13 plasterboard 22 fibreboard beams with struts 260 insulation 160 CLT slab 13 plasterboard	493	145	56	56
		Residential houses sound insulation class ²⁾		B	B
		Offices sound insulation class ³⁾		A	A

¹⁾ Value not available.²⁾ Space outside home to space inside home.³⁾ From space to space for private work or conversations.

5.6 Details

The structure of a building consists, among other things, of several connections between walls/beams, walls/walls or walls/ceilings. Depends on the fire and sound requirements imposed on the building and the structural parts the design may vary. *Figures 5.11 – 5.15* show several principle solutions. *Figure 5.11 – 5.13* shows solutions where the major part of the insulating layers are placed on the under the CLT slab plate and *Figures 5.14 – 5.15, page 105*, show solutions where the insulating layer are placed both on the top and under the CLT slab.

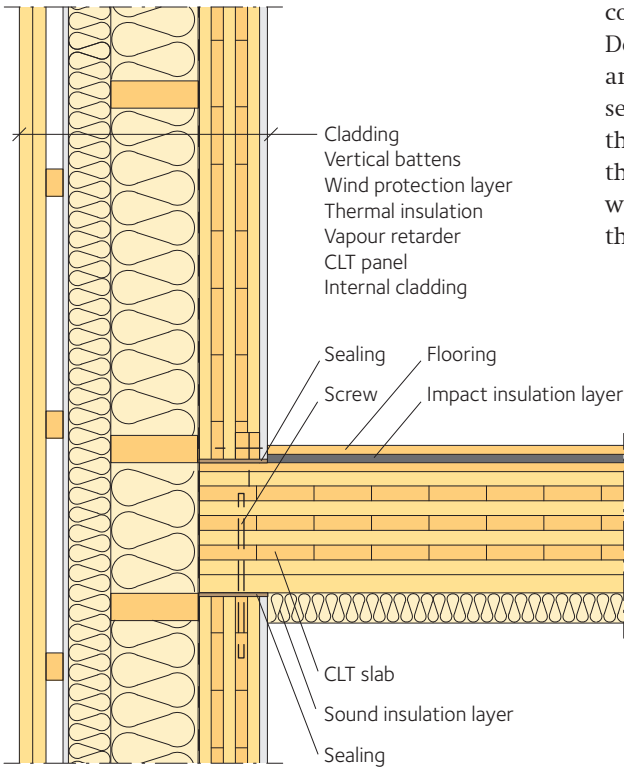

Figure 5.11 Vertical section for building without higher requirements.

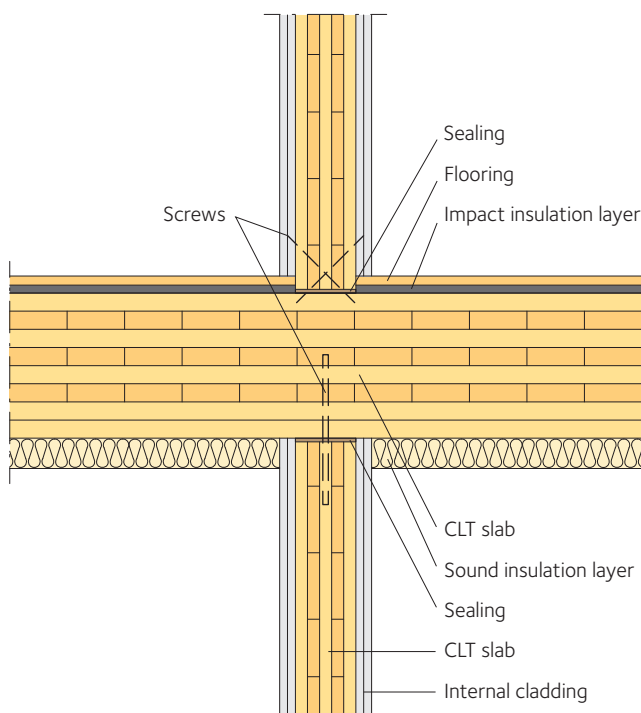

Figure 5.12 Vertical section for building without higher requirements, premises, regarding sound insulation. Joint flooring to bearing inner wall.

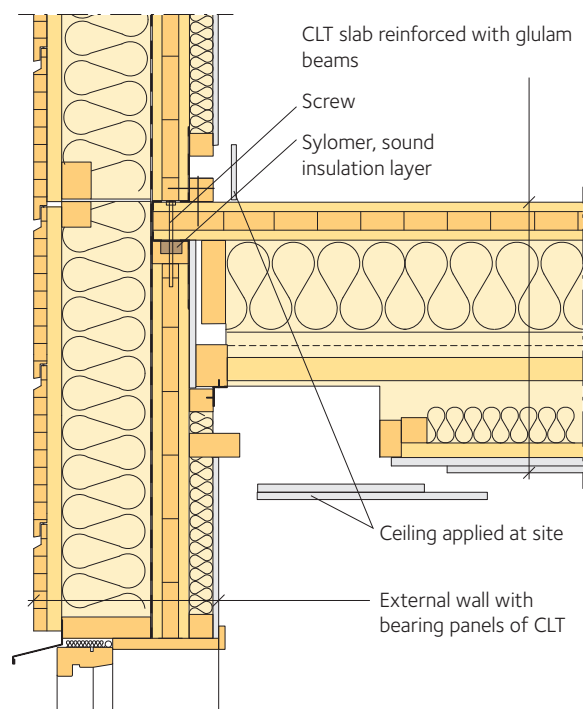

Figure 5.13 Vertical section for building with high requirements, regarding sound insulation. Joint flooring and external wall.

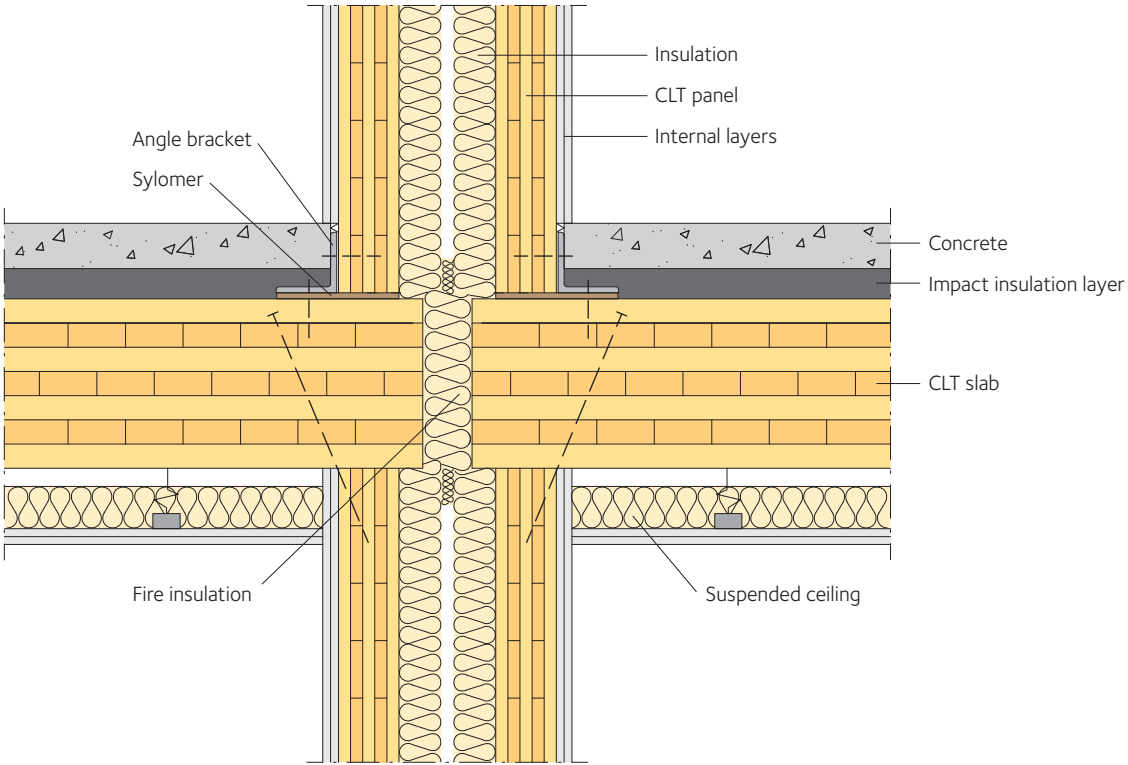

Figure 5.14 Vertical section for building with high demands, regarding sound insulation. Joint flooring to load-bearing apartment separating wall.

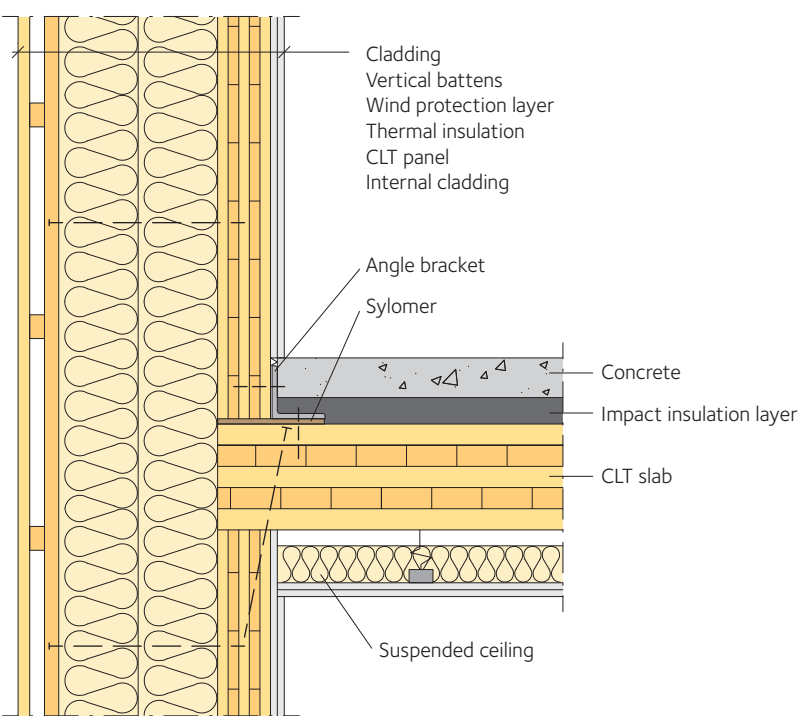

Figure 5.15 Vertical section for building with high demands regarding sound insulation. Joint to exterior wall.

5.7 Example

5.7.1 Design of floor structure

Simply supported floor structure of length $L = 4.5$ m and load and load effects as set out in *table 5.5, page 107*, service class 1.

Loads:

Self-weight $g_k = 1.1$ kN/m²

Imposed load $q_k = 2.0$ kN/m²

The floor structure comprises a 5-layer CLT panel with a thickness of $40 + 20 + 40 + 20 + 40 = 160$ mm and with all the layers of boards in strength class C24. Service class 1, safety class 3 ($\gamma_d = 1$).

For CLT with boards only of strength class C24, the following applies in line with *table 3.7, page 38*:

$$E_{0,x,0.05} = 7,400 \text{ MPa}$$

$$E_{0,x,0.05} = 7\,400 \text{ MPa}$$

$$E_{0,x,\text{mean}} = 11\,000 \text{ MPa}$$

$$G_{9090,x,\text{lay,mean}} = 50 \text{ MPa}$$

$$G_{090,x,\text{lay,mean}} = 690 \text{ MPa}$$

Using *table 3.6, page 38*:

$$f_{m,k} = 24 \text{ MPa}$$

$$f_{v,k} = 4 \text{ MPa}$$

With $\gamma_{mm} = 1.25$ according to *table 3.2, page 35*, and $k_{mod} = 0.8$ according to *table 3.3, page 36* (imposed load is leading action = medium load duration) the design strengths become:

$$f_{m,d} = \frac{k_{mod} \cdot f_{m,k}}{\gamma_M} = \frac{0.8 \cdot 24}{1.25} = 15.36 \text{ MPa}$$

$$f_{v,d} = \frac{k_{mod} \cdot f_{v,k}}{\gamma_M} = \frac{0.8 \cdot 4}{1.25} = 2.56 \text{ MPa}$$

Calculations:

Cross-sectional dimensions for different sizes of 5-layer CLT panels can be found in *table 3.12, page 46* and in *table 3.14, page 50* for CLT panels with boards in strength class C24. Cross-sectional properties can also be calculated for a strip $b_x = 1.0$ m of the board using *table 5.6, page 107*:

Design load combination for vertical load for a strip $b_x = 1.0$ m:

$$q_d = \gamma_G \cdot g_k + \gamma_Q \cdot q_k = 0.89 \cdot 1.35 \cdot 1.1 + 1.5 \cdot 2.0 = 4.32 \text{ kN/m}$$



Example of floor structure.

Moment

Design moment for a single-span beam of length $L = 4.5$ m:

$$M_d = \frac{q_d \cdot L^2}{8} = \frac{4.32 \cdot 4.5^2}{8} = 10.93 \text{ kNm}$$

$$\sigma_d = \frac{M_d}{W_{x,\text{net}}} = \frac{10.93 \cdot 10^3}{3800} = 2.88 \text{ MPa} < f_{m,d} = 15.36 \text{ MPa}$$

Shear force

Design shear force:

$$V_d = 0.5 \cdot q_d \cdot L = 0.5 \cdot 4.32 \cdot 4.5 = 9.72 \text{ kN}$$

$$\tau_d = \frac{V_d \cdot S_{x,\text{net}}}{I_{x,\text{net}} \cdot b_x} = \frac{9.72 \cdot 10^3 \cdot 2600 \cdot 10^3}{30400 \cdot 10^4 \cdot 1000} = 0.083 \text{ MPa} < f_{v,d} = 2.56 \text{ MPa}$$

$$\tau_{Rv,d} = \frac{S_{Rv,\text{net}} \cdot V_d}{I_{x,\text{net}} \cdot b_x} = \frac{2400 \cdot 10^3 \cdot 9.72 \cdot 10^3}{30400 \cdot 10^4 \cdot 1000} = 0.076 \text{ MPa} < f_{Rv,d} = 0.45 \text{ MPa}$$

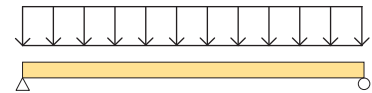
**Table 5.5** Loads and load factors.

Load	kN/m ²	γ_g, γ_Q	Load duration	k_{mod}	Ψ_0	Ψ_1	Ψ_2
g_k	1.1	0.89 · 1.35	Permanent	0.6	-	-	-
q_k	2.0	1.5	Medium duration	0.8	0.70	0.50	0.30

Table 5.6 Properties of 5-layer symmetrical CLT panel, strip of width $b_x = 1.0$ m. Slab thickness 160 mm (40/20/40/20/40).

Property	Calculation formula	Application to example
Net cross-section area (mm ²)	$A_{x,\text{net}} = b_x \cdot 3 \cdot t_1$	$A_{x,\text{net}} = 1000 \cdot 3 \cdot 40 = 1200 \text{ mm}^2$
Net moment of inertia (mm ⁴)	$I_{x,\text{net}} = b_x \left(\frac{t_1^3}{12} + t_1 a_1^2 + \frac{t_3^3}{12} + t_3 a_3^2 + \frac{t_5^3}{12} + t_5 a_5^2 \right) = b_x \left(3 \cdot \frac{t_1^3}{12} + 2 \cdot t_1 a_1^2 \right)$	$I_{x,\text{net}} = 1000 \left(3 \cdot \frac{40^3}{12} + 2 \cdot 40 \cdot 60^2 \right) = 30400 \cdot 10^4 \text{ mm}^4$
Net moment of resistance (mm ³)	$W_{x,\text{net}} = \frac{2 \cdot I_{0,\text{net}}}{h_{\text{CLT}}}$	$W_{x,\text{net}} = \frac{2 \cdot 30400 \cdot 10^4}{160} = 3800 \cdot 10^3 \text{ mm}^3$
Static moment of rolling shear (mm ³)	$S_{R,x,\text{net}} = b_x t_1 a_1$	$S_{R,x,\text{net}} = 1000 \cdot 40 \cdot 60 = 2400 \cdot 10^3 \text{ mm}^3$
Static moment of longitudinal shear (mm ³)	$S_{x,\text{net}} = b_x t_1 a_1 + b_x \cdot \frac{t_3^2}{4 \cdot 2}$	$S_{x,\text{net}} = 1000 \cdot 40 \cdot 60 + 1000 \cdot \frac{40^2}{4 \cdot 2} = 2600 \cdot 10^3 \text{ mm}^3$
Effective moment of inertia (cm ⁴) for span $L = 4.5$ m	$\gamma_1 = \gamma_5 = \frac{1}{1 + \frac{\pi^2 E_{x,1} t_1}{L^2} \cdot \frac{t_2}{G_{9090,2}}}$ $I_{x,\text{ef}} = b_x \left(\frac{3 \cdot t_1^3}{12} + 2 \gamma_1 t_1 a_1^2 \right)$	$\gamma_1 = \gamma_5 = \frac{1}{1 + \frac{\pi^2 11000 \cdot 40}{4500^2} \cdot \frac{20}{50}} = 0.921$ $I_{x,\text{ef}} = 1000 \cdot \left(\frac{3 \cdot 40^3}{12} + 2 \cdot 0.921 \cdot 40 \cdot 60^2 \right) = 28125 \cdot 10^4 \text{ mm}^4$



One family house, Nacka, Sweden.

Deformations

$$\frac{L}{300} = \frac{4500}{300} = 15 \text{ mm}$$

$$w_{g,k} = \frac{5 \cdot g_k \cdot L^4}{384 \cdot E_{x,\text{mean}} \cdot I_{x,\text{ef}}} = \frac{5 \cdot 1.1 \cdot 10^3 \cdot 4.5^4}{384 \cdot 11000 \cdot 10^6 \cdot 28 \cdot 125 \cdot 10^{-8}} =$$

$$= 0.00189 \text{ m} = 1.89 \text{ mm}$$

$$w_{q,k} = \frac{5 \cdot q_k \cdot L^4}{384 \cdot E_{x,\text{mean}} \cdot I_{x,\text{ef}}} = \frac{5 \cdot 2.0 \cdot 10^3 \cdot 4.5^4}{384 \cdot 11000 \cdot 10^6 \cdot 28 \cdot 125 \cdot 10^{-8}} =$$

$$= 0.00345 \text{ m} = 3.45 \text{ mm}$$

Short-term deformation of characteristic load:

$$w_{\text{inst}} = w_{g,k} + w_{q,k} = 1.89 + 3.45 = 5.34 \text{ mm} < 15 \text{ mm} \quad \text{OK}$$

Final deformation because of creep on quasi-permanent action:

$$k_{\text{def}} = 0.85 \text{ for service class 1, in line with table 3.4, page 36.}$$

$$w_{\text{fin}} = w_{\text{inst}} + w_{\text{creep}}$$

$$w_{\text{fin,g}} = w_{g,k} \cdot (1 + k_{\text{def}}) = 1.89 \cdot 1.85 = 3.50 \text{ mm}$$

$$w_{\text{fin,q}} = w_{q,k} \cdot (1 + \Psi_2 \cdot k_{\text{def}}) = 3.45 \cdot (1 + 0.3 \cdot 0.85) =$$

$$= 3.45 \cdot 1.25 = 4.31 \text{ mm}$$

$$w_{\text{fin}} = 3.50 + 4.31 = 7.81 \text{ mm} < 15 \text{ mm} \quad \text{OK}$$

Vibrations

The lowest fundamental frequency, f_1 , for floor structures is calculated as:

$$f_1 = \frac{\pi}{2L^2} \sqrt{\frac{(EI)_L}{m}} = \frac{\pi}{2 \cdot 4,5^2} \sqrt{\frac{11000 \cdot 10^6 \cdot 28 \cdot 125 \cdot 10^{-8}}{110}} =$$

$$= 13,0 \text{ Hz} > 8 \text{ Hz} \quad \text{OK}$$

Control the stiffness by calculating the deflection, w , for a point load, $F = 1 \text{ kN}$ and compare with the largest permitted value $a = 1.5 \text{ mm}$ according to EKS.

$$w = \frac{FL^3}{48EI} = \frac{1 \cdot 10^3 \cdot 4500^3}{48 \cdot 11000 \cdot 28 \cdot 125 \cdot 10^4} = 0.61 \text{ mm} < 1.5 \text{ mm} \quad \text{OK}$$

Check the impulse velocity response v with $b = 100$ according to EKS, and with damping of 2.5 percent in line with *table 5.3, page 98*.

$$v \leq b^{(f_1 \zeta - 1)} = 100^{(13.0 \cdot 0.025 - 1)} = 0.045$$

Floor structures of width $B = 4.5$ m, simply supported along four sides:

$$n_{40} = \left[\left[\left(\frac{40}{f_1} \right)^2 - 1 \right] \left(\frac{B}{L} \right)^4 \left(\frac{(EI)_L}{(EI)_B} \right) \right]^{0.25}$$

$$= \left[\left[\left(\frac{40}{13.0} \right)^2 - 1 \right] \cdot \left(\frac{4.5}{4.5} \right)^4 \cdot \frac{11000 \cdot 10^6 \cdot 30400 \cdot 10^{-8}}{11000 \cdot 10^6 \cdot 3733 \cdot 10^{-8}} \right]^{0.25} = 2.88$$

where:

I_L, I_B is the surface moment of inertia for bending about the y and x axis respectively, in line with *table 3.13, page 47*.

$$v = \frac{4(0.4 + 0.6n_{40})}{mBL + 200} = \frac{4(0.4 + 0.6 \cdot 2.88)}{110 \cdot 4.5 \cdot 4.5 + 200} = 0.004 < 0.045 \quad \mathbf{OK}$$



Balconies made of CLT, Växjö, Sweden.

Walls

- 6.1 Walls – overview 111
 - 6.1.1 Load-bearing external and internal walls 111
 - 6.1.2 Non-load-bearing internal walls 112
- 6.2 Static design 112
 - 6.2.1 CLT and load-bearing capacity 112
 - 6.2.2 Load combinations 112
 - 6.2.3 Load-bearing capacity and stiffness 113
- 6.3 Structure stability 115
 - 6.3.1 Deformation of individual and composite CLT panels 115
 - 6.3.2 Structure stability 116
- 6.4 Fire 121
- 6.5 Acoustic 121
- 6.6 Wall cross-sections 123
- 6.7 Design and detailed solutions 124
 - 6.7.1 Connections wall to foundation 124
 - 6.7.2 Connections wall to floor 125
 - 6.7.3 Connections wall to roof joists 126
 - 6.7.4 Connections external wall to window 126
 - 6.7.5 Connections in external wall corners 127
- 6.8 Example calculations 127
 - 6.8.1 Wall panel with openings – control of buckling 127
 - 6.8.2 Beam over opening, supported by posts 129

Walls are often part of a building's load-bearing structure, but in many instances their task is only protection and separation. In many cases, CLT panels are a clear option, as they can serve as a load bearer while also performing a separating function.

A wall of CLT panels can be anything from a single large surface unit to composite units of multiple smaller surface units. The size of the wall units is limited in the main part by the practicalities of handling and the transport and craning options, but also by manufacturing capacity. CLT walls are built up as panels with a thickness of 60 mm to 300 mm, which means that it is possible to manufacture long, storey-height ceiling wall units with considerable load-bearing capacity. To reduce the risk of large components becoming weak laterally, they can be stiffened with external timbers. In terms of transport, the height of the components should be less than 3.6 m, although in exceptional cases surface units up to 4 m tall can be transported, and the length should not exceed 12 m. Larger units can, however, be transported on a trailer or using specialist transport. Storey-height walls of CLT panels normally weigh between 25 kg/m² and 130 kg/m² depending on the design. Walls are usually delivered with fitted lifting straps or prepared for craning in some other way.

The wall may be made entirely from CLT or supplemented with insulation, façade material, windows and doors. In most cases, external walls are supplemented with further layers of insulation and façade cladding. The smooth surface of the CLT panel provides a good underlay for other panels.

Internal walls are designed according to need and application. The wall may be load-bearing or non-load-bearing. Internal partition walls separating apartments have to meet particular requirements concerning sound insulation and fire resistance, while bathroom walls also have to be designed so that they meet tough standards of moisture-safety. To ensure the moisture-safety, it is important that the connection with other building components is designed correctly, so that transit damage can be avoided.

Common panel thicknesses and compositions are listed in *table 6.1*. Other types of panel can be manufactured on demand. Ask the CLT manufacturers about your requirements.

Table 6.1 Common dimensions for CLT used for load-bearing and non-load-bearing walls. Approximate design values for line load for a 3 m high wall with a load duration class of medium term (M), service class 1 or 2 and safety class 2.

Thickness (mm)	No. of layers	Self-weight (kg/m ²)	Load value q_{Rd} (kN/m)
80	3	40	100
100	5	50	175
120	5	60	320



Cross-section through load-bearing CLT wall.

CLT panels ready for finishing.

CLT panels ready for supplementary layers.

6.1 Walls – overview

6.1.1 Load-bearing external and internal walls

The main task of load-bearing external walls, as well as forming a building envelope, is to take up vertical loads from floor structures above and to transfer wind load to stabilising building components. In cases where the walls are involved in stabilising the structural frame, they also must take up the horizontal loads in the wall's plane. Wind load and internally acting loads such as railing load and live load cause bending moments for which the wall must be designed. The fire load factor can, in many situations, be a defining design factor and means that the thickness of the CLT panel can rarely be less than 70 mm.

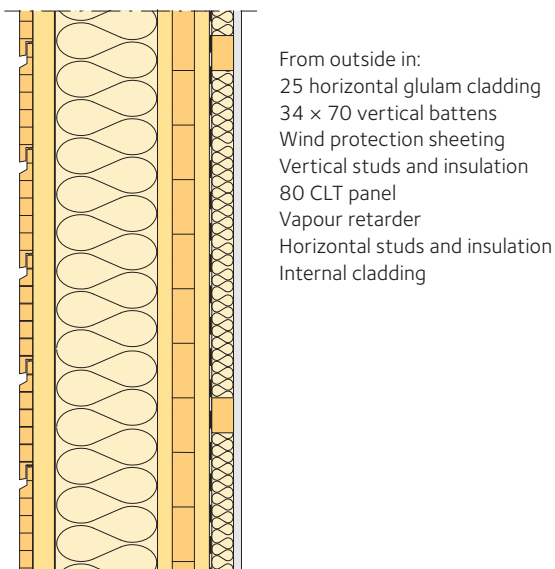

From outside in:
 25 horizontal glulam cladding
 34 × 70 vertical battens
 Wind protection sheeting
 Vertical studs and insulation
 80 CLT panel
 Vapour retarder
 Horizontal studs and insulation
 Internal cladding

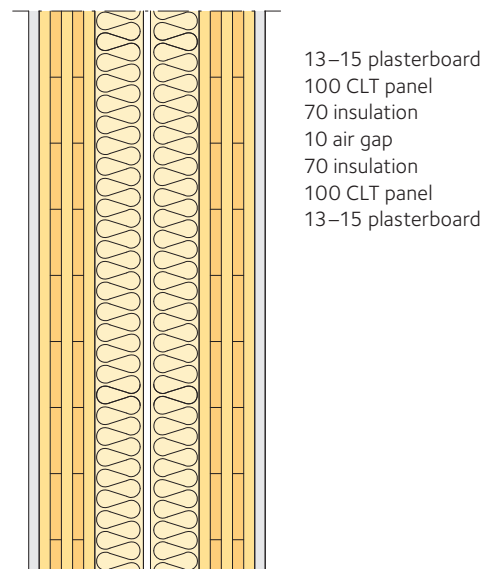

13–15 plasterboard
 100 CLT panel
 70 insulation
 10 air gap
 70 insulation
 100 CLT panel
 13–15 plasterboard

Figure 6.1 Example of external wall structure using load-bearing CLT panel.

Figure 6.2 Example of partition wall between apartments using load-bearing CLT panel.



External wall made of CLT.

The finished wall can be manufactured industrially in its entirety or built on site, based on the prefabricated CLT panel. The principle structure is the same in both cases. CLT panels are commonly supplemented with a wind-proof layer, a heat-insulation layer and a vapour barrier or vapour retarder. Internally, the CLT panel can be fitted directly with interior plasterboard or additional insulation. A less insulated, or uninsulated, gap on the inside may be preferable as it can serve as space for installations. If the fire safety requirements are met, there is an opportunity to leave the CLT panel exposed on the interior. Externally, the wind protection is distanced from the CLT panel with studs or spacing battens.

Load-bearing internal walls usually have just one main task, to lead vertical loads down to the underlying structure or to the foundations. In contrast to an external wall, a load-bearing internal wall often must tolerate the effect of fire from both sides at the same time, where the wall is located within the same fire compartment. If other requirements are met, internal walls can successfully be made from exposed CLT.

6.1.2 Non-load-bearing internal walls

Internal walls are designed differently, depending on their type. In most cases, the desire is for a wall in its simplest form, which generally means a stud wall. CLT can be chosen for internal walls that are not load bearing, where a heat and moisture-resistant frame is required. Internal party walls must meet particular requirements concerning sound insulation and fire resistance, while bathroom walls also have to be designed so that they meet tough standards of moisture-proofing. CLT panels are also used for internal walls in buildings where high mechanical strength and resistance to external actions are required, such as in sports halls and stables.

6.2 Static design

6.2.1 CLT and load-bearing capacity

CLT panels that are affected by vertical loads and moments, for example from eccentric loads from floor structures or wind load, are to be designed as bending and compression members. In most cases, the deformation occurs in the structure's weak direction, and so the rules for bending and compression columns can be applied. Mass timber structures under compression can be designed as CLT in line with Eurocode 5. For the slender CLT panels, the stability factor is usually critical for the wall's load-bearing capacity. Bearing pressure on the wall's ends and against sills and floor structures must also be checked.

6.2.2 Load combinations

When designing walls, there are three main variable loads to consider: imposed load, snow load and wind load. The design should be checked based on each of these loads being considered a leading action. A wall is usually checked in the ultimate limit state and the design value for load effect E_d of the load combination is calculated using *equation 6.1* as stated in the Eurocode (SS-EN 1990, *equation 6.10b*) and applicable EKS:

$$6.1 \quad E_d = \gamma_d \cdot 0.89 \cdot 1.35 \cdot G_k + \gamma_d \cdot 1.5 \cdot Q_{k,1} + \sum_{i=2}^n \gamma_d \cdot 1.5 \cdot \psi_{0,i} \cdot Q_{k,i}$$

where:

- γ_d is the partial factor for safety class.
- G_k is the load effect of permanent actions.
- $Q_{k,1}$ is the variable leading action.
- Ψ is the load combination factor.
- $Q_{k,i}$ are other variable actions.

6.2.3 Load-bearing capacity and stiffness

The load-bearing capacity and stiffness of walls made from CLT panels is generally calculated on the basis that normal forces and bending moment are taken up only by the panel, and not by a secondary composite structure. There are two options for designing CLT panels: designing with the help of available diagrams or tables and designing through calculation. Diagrams and tables should however be used primarily for initial design values.

Designing with the help of available diagrams or tables

Since most CLT manufacturers provide design help for their products, it can be a good idea to make use of these tools. Many manufacturers, for example, use design diagrams like *figure 6.3*. When using these tools, it is important to note the conditions for which the stated values apply. Check the safety class, load duration, service class, support system, and note whether account has been taken of any eccentric load.

a) **Determine the design loads** in the ultimate limit state, i.e. the design value for vertical load F_d and transverse load q_d for the load case in question. Walls do not usually require designing in the serviceability limit state.

b) **Determine the wall's buckling length, l_e .**

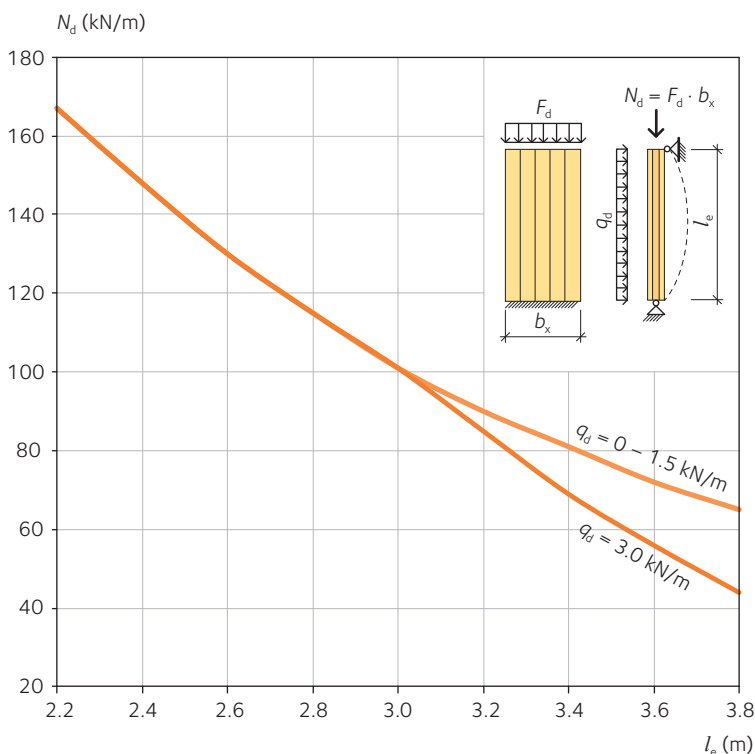

Figure 6.3 Permitted vertical load for CLT panels with a thickness of 80 mm.



Assembly of CLT walls.



Building for boats, Skellefteå, Sweden.

c) Determine the load-bearing capacity using design diagrams.

The diagram in *figure 6.3*, for example, shows the calculation for a load duration class of medium term (M) for vertical load and short term (S) for transverse load, service class 1 or 2 and safety class 3, plus the loads on the wall are taken to be centric. For walls under eccentric loads, a supplement is made to the horizontal load equating to the additional moment arising from the load's eccentricity. The load-bearing capacity is compared with the design value for vertical load F_d .

Designing through calculation (see also section 3.3.5, page 52)

a) Determine the design loads in the ultimate limit state, i.e. the design value for vertical load F_d and transverse load q_d for the load case in question.

b) Calculate the design load effects.

Determine the design value for normal force, N_d based on the load conditions in question, which may be bearing loads from a floor structure, for example.

Determine the design moment:

$$6.2 \quad M_d = \frac{q_d l_e^2}{8}$$

where:

- l_e is the wall's buckling length.
- q_d is the design value for transverse load.

In a normal case, the wall's buckling length is the same as the wall's true height. When calculating the design moment, the contributing moment from vertical loads due to the eccentricity of the supports must also be considered.

The bending stresses that arise are calculated as follows:

$$6.3 \quad \sigma_{m,y,d} = \frac{M_{y,d}}{W_{x,net}} \leq f_{m,xlay,d}$$

where:

- $M_{y,d}$ is the moment design value.
- $W_{x,net}$ is the panel's net moment of resistance.

c) Control of cross-section in the case of pure axial compression

According to the principles of the Eurocodes, wall panels are designed using linear buckling theory. Non-linear effects (effects of other systems) are considered in designs with the help of a strength-related reduction factor k_c . The condition that must be met in *equation 6.4* is:

$$6.4 \quad \sigma_{c,x,d} = \frac{N_d}{A_{x,net}} \leq k_c \cdot f_{c,0,xlay,d}$$

where:

- $A_{x,net}$ is the wall's net cross-section, i.e. the vertical board layers.
- k_c is a reduction factor that accounts for the buckling risk.
- $f_{c,0,xlay,d}$ is the design value for the strength parallel with the grain.

d) Control of cross-section in the case of combined bending and axial compression

Theoretically, in a load-bearing wall panel axial compression and bending can occur simultaneously about both axes. In most cases, however, there is only one direction that is of interest when designing for compression and bending.

Table 6.2 Example of characteristic strength and stiffness values for CLT panels when calculating in the ultimate limit state. The $E_{0,05}$ values are based on the gross area of the whole cross-section. Other values relate to the net area.

Thickness (mm)	Bending, modulus of elasticity $E_{0,05}$ (MPa)	Compression $f_{c,k}$ (MPa)	Bending $f_{m,k}$ (MPa)
80 (3-layer)	9,500	21	24
100 (3-layer)	8,600	21	24
120 (5-layer)	9,450	21	24

The condition that must be met in *equation 6.5* is:

$$\frac{\sigma_{c,x,d}}{k_c \cdot f_{c,0,x,lay,d}} + \frac{\sigma_{m,y,d}}{f_{m,x,lay,d}} \leq 1 \quad 6.5$$

where:

- $\sigma_{c,x,d}$ is the design value for the compression stress.
- $\sigma_{m,y,d}$ is the design value for the bending stress about the panel's y-axis.
- $f_{m,x,lay,d}$ is the design value for the panel's bending strength (usually about the panel's y-axis).

Examples of characteristic strength and stiffness values that can be used in calculations, if no data is available from the CLT manufacturer, can be found in *table 6.2*.

6.3 Structure stability

6.3.1 Deformation of individual and segmented CLT walls

CLT panels are ideally suited to building stabilisation, as they have high stiffness and load-bearing capacity. In a building, loads are normally transferred from the floor structure to stabilising walls. A full wall often comprises multiple wall panels that are connected with vertical joints. The wall unit is exposed to a horizontal load in the wall unit's plane that causes shear stresses and bending stresses. The stresses in the material, combined with displacements in the joints, give a total deformation in the panel's plane due to the horizontal load. In normal cases, the deformation in joints and connections is a design value.

If the whole panel's shear modulus, G_{mean} and modulus of elasticity, E_{mean} are known, the total deformation, δ_{tot} can be expressed as:

$$\delta_{\text{tot}} = \delta_{\text{shear}} + \delta_{\text{bend}} + \delta_{\text{join}} \quad 6.6$$

Deformation due to shear forces, see *figure 6.4*, can be expressed using *equation 6.7*:

$$\delta_{\text{shear}} = \frac{F_d \cdot h}{b \cdot t_{\text{tot}} \cdot G_{\text{mean}}} \quad 6.7$$

where:

- F_d is the design value for the horizontal load acting on the panel.
- h is the panel's height.
- b is the panel's width.
- G_{mean} is the panel's shear modulus.
- t is the panel's total thickness.

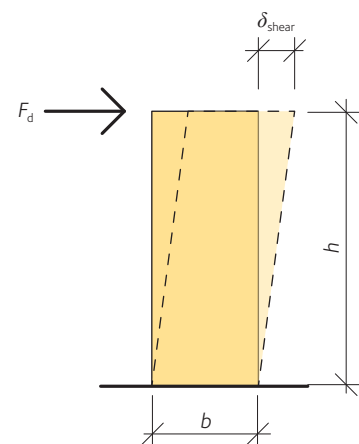

Figure 6.4 CLT panel deformation due to shear forces.

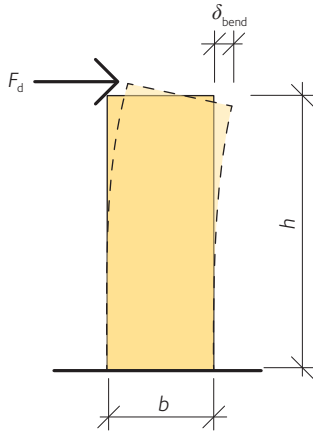

Figure 6.5 CLT panel deformation due to moment.

The panel's deformation due to moment, see figure 6.5, can be expressed using equation 6.8:

$$6.8 \quad \delta_{\text{bend}} = \frac{F_d \cdot h^3}{3 \cdot E_{\text{mean}} \cdot I}$$

where:

- F_d is the design value for the horizontal load acting on the panel.
- h is the panel's height.
- E_{mean} is the panel's modulus of elasticity.
- I is the panel's moment of inertia.

The panel's deformation due to displacements in the joints, see figure 6.6, can be expressed using equation 6.9:

$$6.9 \quad \delta_{\text{join}} = \gamma \cdot h = \Delta\gamma \frac{h}{b}$$

where:

- h is the panel's height.
- b is the panel's width.
- γ is the angle change in radians.

$$6.10 \quad \Delta\gamma = \frac{F_d}{K_{\text{ser}}}$$

where:

- F_d is the design value for horizontal load.
- K_{ser} is the stiffness of the joint.

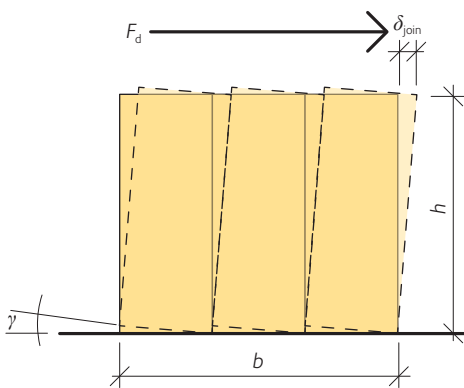

Figure 6.6 CLT panel deformation due to joint displacements.

The stiffness values for the joint and the stiffness of the panel are determined by the design of the connection and the structure of the panels. Manufacturers and suppliers of screws and fixings can, in many cases, provide data on stiffness values. Table 6.3 and table 6.4 state approximate values for a few different connections and panels.

Control of shear stresses, see section 3.3.5, page 52.

Table 6.3 Characteristic values per screw pair in ultimate limit state and serviceability limit state for a connection that comprises Spax 5 × 40 wood screws, or equivalents, and a plywood strip 12 × 60 of strength P30. The centre spacing between the wood screws must be greater than 40 mm, with values empirically sourced.

Ultimate limit state F_{Rk}	Serviceability limit state K_{ser}
1.5 ¹⁾	0.5 ²⁾

¹⁾ Max. load at 9 mm deformation.

²⁾ The stiffness value applies to deformations up to 2 mm.

Table 6.4 Properties of CLT panels for calculation in the serviceability limit state with loading in the wall panel's plane. The stiffness values are based on the gross area of the whole cross-section.

Panel thickness (mm)	Shear modulus G_{mean} (N/mm ²)	Modulus of elasticity $E_{m,0,\text{mean}}$ (N/mm ²)
80 (3-layer)	400	6,400
100 (3-layer)	400	5,700
120 (5-layer)	400	6,200

6.3.2 Structure stability

Single homes and other small buildings with no more than two storeys and in less exposed locations do not need to be checked using calculations. Sufficient stability can usually be achieved simply with external walls and partition walls comprising studs and sheet cladding. Certain parts of the building with open plan layouts or with large expanses of glazing should, however, be checked.

A high-rise block in wood tends to be stabilised against horizontal loads by using walls and floor structures as stiff, force-absorbing panels. In some cases, long ties that stretch from the foundations to the top floor structure may be needed to achieve sufficient stability and anchoring.

The wind load against the building's walls and roof is led in via the floor structures and on to the stabilising walls of the building. The external walls lead half of the load to the upper floor structure and half of the load to the lower floor structure. The diaphragm action in the floor structure distributes the load to the supporting walls. The stabilising walls must have enough load-bearing capacity

and stiffness that they can transfer both shear forces and vertical lift and compression forces. In buildings with multiple floors, it is common to use all the walls to stabilise the building. It is not uncommon for the stabilising walls to be placed so that a torsional moment is caused by wind load on the façade. This moment can be taken up by a wall placed perpendicular to the stabilising walls for this wind direction. The walls are subject to both compression and tensile forces at each end.

Checking overturning and sliding

The building must be controlled for both an overturning moment and a horizontal ground reaction. When checking overturning and sliding, the building is usually treated as a single unit, including the foundations. This places requirements on the connection between the stabilising superstructure and the foundations.

Overturning is checked by calculating that the building's self-weight is sufficient to counter the wind load's overturning moment. A simple and reassuring way to ascertain safety against overturning is to check whether the load results for the vertical ground reaction lie within the building's core limit. The core limit can be assumed to lie approximately within a sixth of the building's width, measured from the centre line, see figure 6.7.

If the self-weight of the building and foundations does not provide sufficient resistance to overturning, the design of the building must be changed by increasing the self-weight or anchoring the foundations into the ground below. The self-weight is to be reduced by a factor of 0.9 in line with prevailing standards, since the self-weight should be favourable in this case.

Securing the design against sliding at the foundations is not usually a major problem. It is checked by ensuring that the shear stress between the foundation slab and the ground does not exceed the shear strength, which is determined by the undrained shear strength of the soil when building on cohesive soil, or the material's inner angle of friction when building on frictional soil.

Diaphragm action

The distribution of the loads between the stabilising walls depends on the relationship between the stiffness of the floor structure and the stiffness of the walls.

Normally, the floor slab is entirely stiff as compared with the wall panels, which means that the distribution of the loads between the walls depends on the placement of the walls and the integral stiffness of the walls.

In the case of frame systems with stabilising walls in CLT and weak floor structures (e.g. non-reinforced beam floors), the floor structures should be weak, which means that the loads are transferred based only on the placement of the walls. For CLT slabs, wind loads can be distributed to stabilising walls based on the stiffness of the floor slab.

For buildings that are non-symmetrical in terms of the location and stiffness of the stabilising walls, the wall panels in the building's other direction are included in the stability calculation to take account of the twisting that occurs in the floor structure, see figure 6.9.

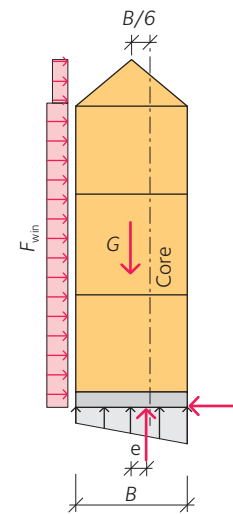

Figure 6.7 Checking for overturning.

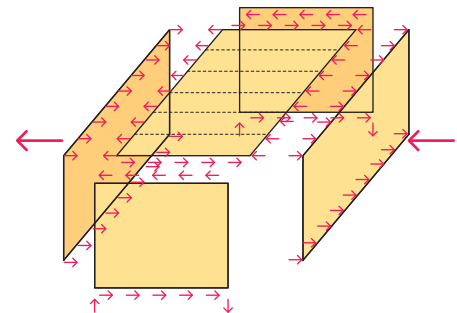

Figure 6.8 Diagram of load transfer stabilising wall panels.

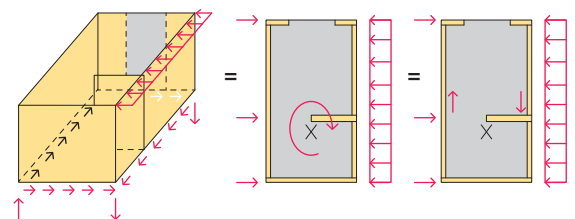

Figure 6.9 Diagram of load distribution in a non-symmetrical building.

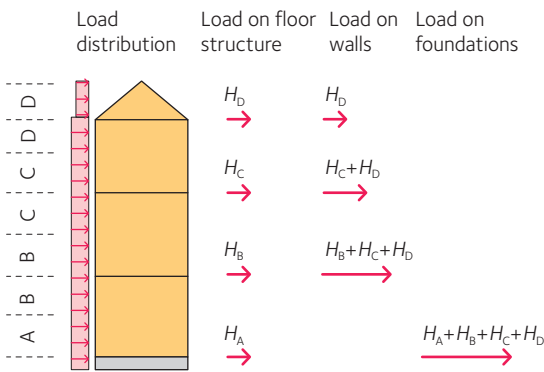

Figure 6.10 Stresses on floor slabs and wall panels.

The horizontal forces that walls and floor structures must resist when stabilising multi-storey buildings are shown in figure 6.10. The wind load is distributed to the upper and lower floor structure. If the wind load is constant across the whole height, all the floor structures (except the floor structures of the top floor and ground floor) are subject to the same forces.

The shear force in the wall panels will, however, increase, the further down the building you come, since the horizontal loads are added storey by storey.

Since it must be possible for the forces that occur to be fully transferred between walls and floor structures and led down to the ground, the nodes must be designed for this.

The calculation of the diaphragm action can be written as:

1. Determine horizontal loads on the windward and leeward side and the sway forces.
2. Determine horizontal loads for each floor structure.
3. Determine horizontal loads for each stabilising wall.
4. Check the floor structures' shear resistance for components and component joints.
5. Check the walls' shear resistance for components and component joints.
6. Check connections between walls and floor structures for horizontal shear forces.
7. Check nodes for vertical tensile and compression forces.
8. Check the risk of progressive collapse.
9. Check horizontal deformations.

Horizontal anchoring between wall and floor structure

Some form of mechanical connection is usually required to achieve sufficient shear resistance between the stabilising wall panels and the floor slabs.

In those exceptional cases where the risk of progressive collapse does not need to be considered, the friction between the components can be counted in order to transfer the horizontal forces between stabilising structural components.

For supported floor structures, the connection between the floor structure and the wall resting on top must be designed for a shear force equivalent to the horizontal load on the wall above it. For suspended floor structures, the connection between the floor structure and the wall needs to be designed for the horizontal force that the floor structure transfers to the respective underlying stabilising wall, see figure 6.11.

Vertical anchoring between wall and floor structure

Horizontal loads that are transferred to stabilising walls will cause both horizontal and vertical reaction forces in the lower edges of the walls due to the overturning moment. The wall can be prevented from lifting by loading the wall or through an anchor. The wall can also be prevented from lifting through connections to adjacent anchored wall panels. The design of the anchor for a wall panel thus depends on the size of the horizontal force that the wall has to resist, the weight of the structures above, and the wall's connection with adjacent walls.

Walls with openings can be designed either in a simplified form or through a full analysis. In the simplified method, each full-height

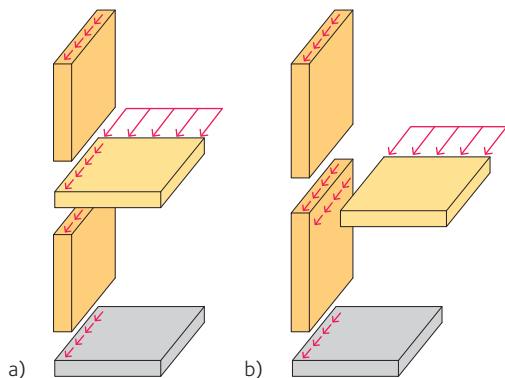

Figure 6.11 Transfer of horizontal forces between wall panels and floor slabs for supported and suspended floor structures.

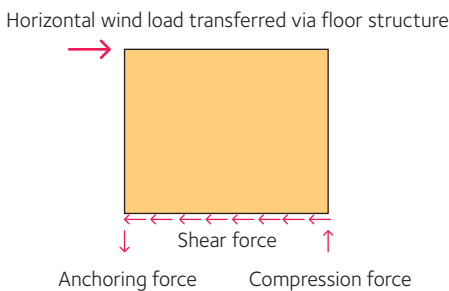

Figure 6.12 Force equilibrium for stabilising wall panel.

wall section with no openings is considered a separate, completely anchored wall panel. In a full analysis, the total load-bearing capacity is calculated, including wall sections above and below openings.

The simplified method means that in most cases anchors are also required at the openings, *see* 6.13.

A full analysis can mean that anchors are not needed at openings. If anchors are to be omitted, the CLT panels above and below the openings must have sufficient bending and shear resistance. This can be verified through testing or detailed calculations.

The vertical reaction forces from the stabilising walls above affect the need for and design of any anchors. This means that the anchoring force becomes greater, the lower down in the building you go.

Where there is a need for an anchor, it is important that the force can be lead directly down to the ground below. There are different types of anchors that can achieve this, including anchor rods and various forms of angle bracket. The anchors should normally should be prestressed to a certain extent to compensate for the long-term deformations that occur over the lifetime of the building

Calculation process for checking lift:

1. Determine vertical reaction forces caused by horizontal load for each wall panel.
2. Determine distribution of self-weight for each wall panel.
3. Check whether lift occurs for each wall panel and provide anchoring if necessary.

In taller buildings, the total compression forces can be much larger, which can lead to the strength perpendicular to the grain in the underlying CLT panels, floor beams or other connecting details being exceeded. A check of the compression capacity of the nodes must therefore be carried out using *equation* 6.11:

$$\sigma_{c,90,d} = \frac{F_{c,d}}{A} \leq f_{c,90,d}$$

6.11

where:

- $\sigma_{c,90,d}$ is the design compression perpendicular to the grain.
- $F_{c,d}$ is the design value for the total compression force from the structures above.
- A is the compression loaded area. With CLT, do not choose a length of more than $\frac{1}{4}$ of the total wall length, and only include the wall surface parallel to the grain, where compression perpendicular to the grain occurs, unless a load-distributing intermediate layer is used.
- $f_{c,90,d}$ is the design value for compressive strength perpendicular to the grain.

The load case that gives the greatest stresses depends on the geometry, use and geographic location of the building. A check should usually be carried out for the following load cases:

- Wind with a characteristic value (leading action) and the combination value for snow load and imposed load.
- Imposed load with a characteristic value (leading action) and the combination value for snow load and wind load.
- Snow load with a characteristic value (leading action) and the combination value for wind load and imposed load.

Horizontal wind load transferred via floor structure

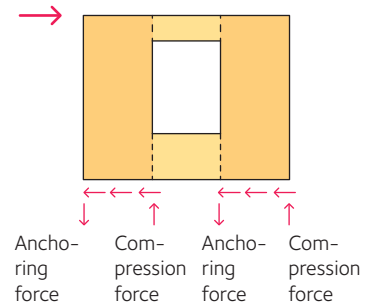

Figure 6.13 Force equilibrium using simplified method for stabilising wall panel with opening.



Example of external wall.



Example of partitional wall.

Progressive collapse

With buildings that have a load-bearing structure of CLT, it is usually not appropriate to design individual components for other constituent parts of the frame to resist accidental loads (e.g. explosive or impact loads). Instead, the composite frame system should be designed so that individual components can be knocked out without this leading to progressive collapse. The size and location of damaged areas can be determined using the principles set out in the relevant standards.

When designing for progressive collapse, the building's overall stability after primary damage and the building's structural continuity should both be checked. The overall stability of a building with primary damage is usually no problem for construction systems using CLT, since several stabilising walls are usually included in the stabilisation system. There is therefore plenty of scope to redistribute loads if a certain component is taken out of action.

Horizontal deformation

When calculating the horizontal deformations in a CLT structural system, both deformations in the individual structural components and deformations in the connections are considered. Since CLT panels are mostly extremely stiff, the greatest deformations occur in the joints.

In practice, it has been shown that the deformations in the serviceability limit state do not usually cause any problems and this check is therefore not usually carried out. There is a general lack of simple calculation methods for this type of check. However, with tall buildings of more than 8 – 10 storeys, it may be relevant to check horizontal deformation. There are commonly hidden capacity reserves that are not included in the design calculations, for example non-load-bearing walls or stabilising internal walls, which also contribute to the stiffness of the building. Research is currently underway in these areas.

The calculation process for a rough check of deformations may be as follows:

1. Determine the stress in the serviceability limit state for the walls and connections in each line of stabilising wall.
2. Determine the deformations in the individual walls based on approximate calculation formulae.
3. Determine the deformations in the individual connections based on approximate calculation formulae (see, for example, Eurocode 5, "joint slip modulus").
4. Calculate the total deformation across the entire height of the building along the wall line with the greatest load and check against set requirements (e.g. $h/500$, according to what has previously been stated in the standards). Also check the individual storeys.
5. If necessary, determine the deformations in the individual floor structures based on approximate calculation formulae.

6.4 Fire

When designing the bearing system, high reliability is also required regarding fire safety. If the requirements for class E (integrity) and class I (insulation) during a fire are met, load-bearing reserves in the global structure may be drawn on. An example of this is that a post in a fire compartment can be designed for lower fire resistance than other load-bearing parts of the fire compartment on condition that there is an alternative way to take up the load. When stabilising a high-rise building, the diaphragm action and stability of the building will often have to be ensured, even if the diaphragm action is partially reduced in a fire.

Fire safety is usually designed into building structures at component level, which involves taking an individual look at each structural component, such as walls, floor structures and posts, irrespective of any restraint in the supports. This corresponds to the same conditions as in fire safety testing. There are theoretical models for CLT panels, where the composition of the panel in terms of alternating layers is critical for the load-bearing capacity.

The charring rate of coniferous wood is 0.65 – 0.80 mm/minute according to Eurocode 5. In a fire, an asymmetry occurs regarding the geometry and mechanical properties that usually form the basis of the design, *read more in chapter 7, page 133*. Table 6.5 contains a summary of the fire resistance classification for certain CLT wall panels.

Table 6.5 Example of CLT walls that meet the requirements for fire resistance, EI, over different periods. The fire resistance applies on condition that the CLT panels are fixed to an adjacent structure.

Fire resistance classification	Panel thickness (mm)
EI60	80 (3-layer)
EI90	120 (5-layer)

6.5 Acoustic

CLT panels are orthotropic, which means they have different stiffness in different directions. This makes the ambient sound insulation significantly different from other homogeneous materials. Figure 6.14 provides an example of measured sound insulation in two different structures, both using mass timber with a thickness of 65 mm. The difference is that one is a weaker nailed wall panel and the other is a CLT wall panel.

The lower stiffness of the nailed wall provides better sound insulation: $D_{w+C50-3150}$ is 34 dB for the nailed wall and 30 dB for the bonded wall.

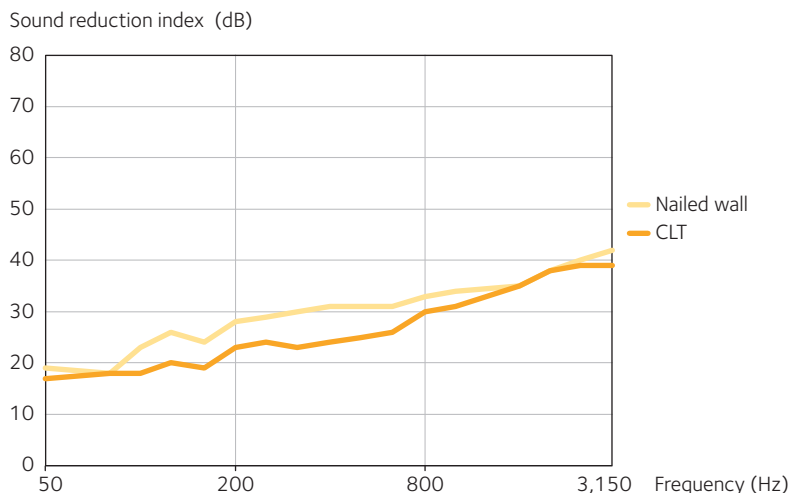

Figure 6.14 Sound reduction index measured in a laboratory for single mass timber panels with a thickness of 65 mm and a nailed or a bonded structure, in the frequency range 50 – 3,150 Hz.

Extremely high sound insulation can be achieved with a double structure. *Figure 6.15* shows the weighted sound reduction index for a double structure comprising two 65 mm thick CLT panels, where the gap is filled with insulation. The results have been obtained through interpolation from measurements for a 100, 150 and 200 mm gap. The lines on the graph are based on laboratory measurements and, like the other data in this section, include no safety margins. The panel thicknesses used here are also not standard thicknesses.

Double walls provide sufficient sound insulation for situations with very high demands, including everything from housing to music rooms in schools. Single walls, on the other hand, do not generate particularly good values and therefore cannot normally be used where there are sound insulation requirements. One should, however, bear in mind that the sound insulation curves are steady and do not have any frequency ranges with particularly poor insulation. This means it is not inconceivable that the single walls could be used as partition walls in apartment blocks.

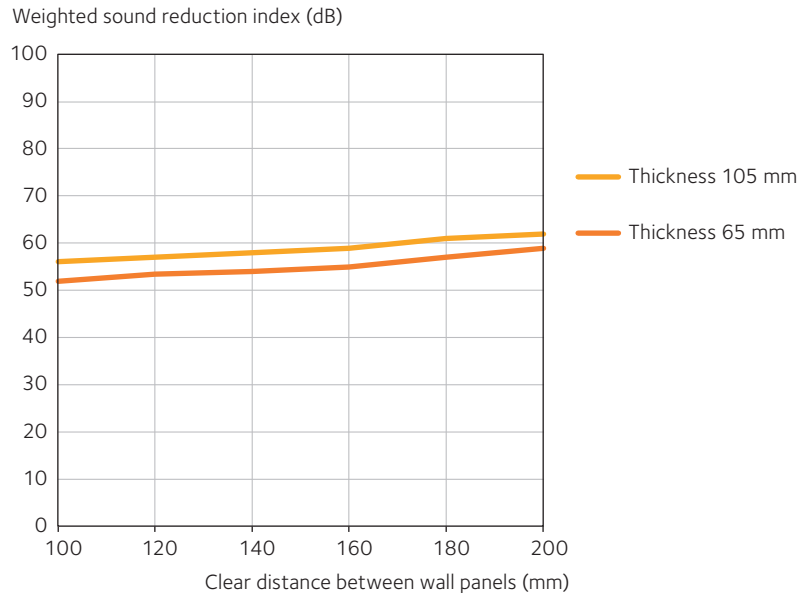

Figure 6.15 Weighted sound reduction, $R_{w,50-3150}$, for a double wall using CLT panels of thicknesses 105 mm and 65 mm. The values obtained from laboratory measurements, without any safety margins.

Table 6.6 Weighted sound reduction for single and double CLT wall panels.

Wall type	Panel thickness (mm)	Air gap between walls (mm)	Insulation thickness (mm)	$R_{w,50-3150}$ (dB)
Single sheet of CLT	65	–	–	31 (-1)
Single sheet of CLT	105	–	–	34 (-1)
Double sheet of CLT	2 × 65	10	2 × 70	55 (-3)
Double sheet of CLT	2 × 65	10	2 × 95	58 (-2)

6.6 Wall cross-sections

When it comes to the composition of external walls, many options and preferences come into play. Exposed on the inside, internal layer for installations, lightweight insulation between studs or thick insulation and just long wood screws to fix the façade layer in place – these are just some of the possible combinations. Several different variations on the composition of external walls are presented below. The stated values are to be taken as a guide only.

Table 6.7 Selection of external wall designs.

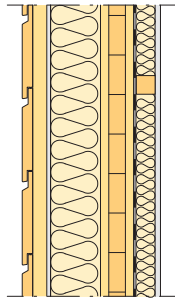
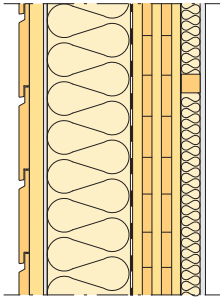
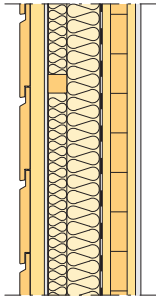
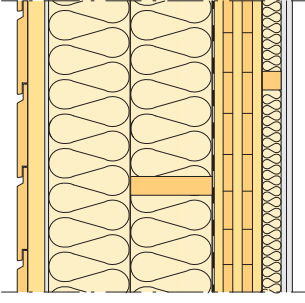
Wall type	Material (mm)	U-value [W/m ² K]	Total thickness (mm)	Fire class	Ljudisolering $D_w (C; C_{tr})$
	Wall type 1 22 external cladding 34 battens Wind protection 120 heavy insulation 80 CLT panel Vapour retarder 45 studs and insulation 13 plasterboard	0.25	314	REI60	38 (-;-4)
	Wall type 2 22 external cladding 34 battens Wind protection Vapour retarder 195 heavy insulation 100 CLT panel 45 studs and insulation 13 plasterboard	0.15	409	REI60	41 (-;-)
	Wall type 3 22 external cladding 34 battens Wind protection 45 studs and insulation 95 insulation Vapour retarder 80 CLT panel 15 fire-resistant plasterboard	0.25	291	REI60	51 (-3;-9)
	Wall type 4 22 external cladding 34 battens Wind protection 170 vertical studs and insulation horizontal studs and insulation Vapour retarder 100 CLT panel 45 studs and insulation 2 x 13 mm plasterboard	0.10	567	REI90	52 (-;-)

Partition walls are required to provide separation between two apartments in terms of fire and sound, and often party walls also must handle vertical and horizontal loads. The composition of party walls using CLT can, in principle, be divided into two alternatives: double CLT wall panels and single CLT wall panels that are encased in stud structures. Several different variations on the composition of party walls are presented below. The stated values are to be taken as a guide only. See also table 8.15, page 155.

Table 6.8 Selection of partition wall designs.

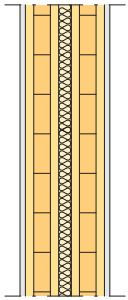
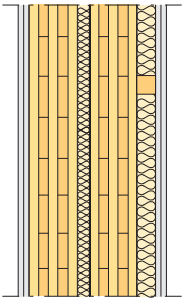
Wall type	Material (mm)	Total thickness (mm)	Fire class	Sound insulation $D_w (C; C_{tr})$
	Wall type 1 13 plasterboard 80 CLT panel 30 insulation 80 CLT panel 13 plasterboard	216	REI60	56 (-;-)
	Wall type 2 22 x 13 plasterboard 100 CLT panel 30 insulation 100 CLT panel 45 studs and insulation 2 x 13 plasterboard	327	REI90	62 (-;-)

6.7 Design and detailed solutions

6.7.1 Connections wall to foundation

There are various ways to connect an external wall to the foundation. Where the wall is built up on the construction site, a CLT panel is delivered and then fitted with insulation, weatherproofing, façade cladding, windows and doors on site. Adding additional layers on site offers excellent opportunities to conceal the fixings. When a wall is prefabricated, the delivered product includes installation, weatherproofing and possibly façade cladding, depending on type, plus windows and doors as required. A common method of fixing a wall in place is to attach a sole plate to the foundations to serve as both a fixing and a guide rail for the wall. The CLT panel is then screwed from the inside into the sole plate fixed to the concrete slab, see figure 6.16, page 125. A waterproof strip must be placed on top of the sole plate to provide a good seal against the lower edge of the prefabricated wall.

The highest lift and shear forces tend to occur in the connection between the wall and the foundations. To meet the requirements concerning the connections' load-bearing capacity and weatherproofing, it is important that the foundations are made with very small dimensional tolerances. Having very little unevenness in the foundations also makes the fitting of the mass timber components more efficient. For more information on fixings, see section 4.4.6, page 79.

6.7.2 Connections wall to floor structure

The connection between a load-bearing wall and a floor structure is the node that most often must meet a large number of functions: transferring loads both vertically and horizontally, while at the same time meeting the physical requirements concerning weatherproofing and insulation, as well as the fire safety and sound requirements. There are, in principle, two methods for connecting the floor structure and a wall: the supported floor structure and the suspended floor structure.

With a supported floor structure, see figure 6.17, the floor structure rests on the load-bearing wall below. The advantage of placing the floor structure on the wall is primarily the ease of construction and the fact that the vertical load comes down centrally on the load-bearing wall. The CLT floor slab is placed on the load-bearing CLT wall panel. A flanking transmission strip is placed between the floor and the wall, taking account of the bearing pressure. The floor slab is fixed to the underlying wall with an angle bracket or wood screws. The number of screws and fixings is determined by the conditions that apply for the building in question. If a supplementary layer is required to meet the fire safety and sound classifications, it may be possible for this to be included in the floor structure delivery so that only minor additions are required on site.

Depending on the requirements concerning sound insulation, surface layer and so on, the top of the floor structure in a bathroom may be finished with gypsum flooring, waterproofing and tiles/carpet, see chapter 8, page 145. In other rooms, the floor may be finished with carpet or wood flooring.

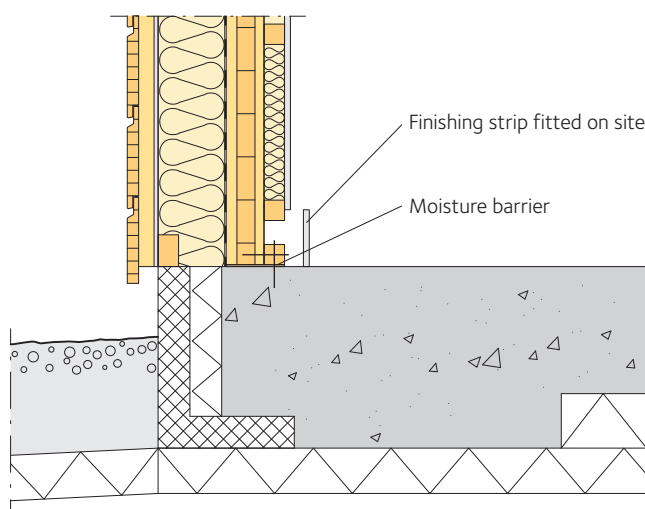

Figure 6.16 Connecting prefabricated external CLT wall to concrete slab.

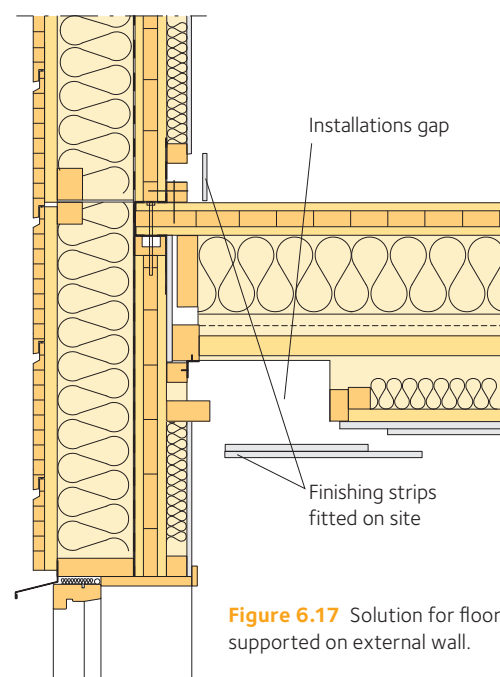

Figure 6.17 Solution for floor structure supported on external wall.

With a suspended floor, the connection involves placing the floor structure between the load-bearing walls. The floor is suspended on specially designed hangers or on a support beam fixed along the wall.

The benefit of using suspended floor structures is that flanking transmission strips of lower density and load-bearing capacity can be used, which saves money. For taller buildings with major vertical loads, it can be difficult to find flanking transmission strips with enough load-bearing capacity. Another advantage over supported floor structures is that you have less wood subject to large vertical loads perpendicular to the grain.

6.7.3 Connections walls to roof joists

Roof joists and CLT panels can be connected using angle brackets, truss hangers or skew screwing directly into the CLT panels. The bearing pressure between a traditional roof structure and the CLT panel can be relatively large, since the wall panel is relatively thin and the roof's tie beams are usually only 45 mm timbers. To distribute the bearing pressure, the roof truss can have glued and nailed wooden cover plates added.

Moisture-proofing and thermal insulation are achieved by continuing the wall structure up into the roof, with external moisture protection provided by the external cladding, air gap and diffusion-open vapour control membrane. Internally, the wall's vapour control membrane is connected to the vapour control membrane of the roof.

6.7.4 Connections external wall to window

CLT panels provide great freedom when it comes to designing the way windows, doors and fixings are mounted. When mounting windows and doors, there are basically two main solutions: mounting directly

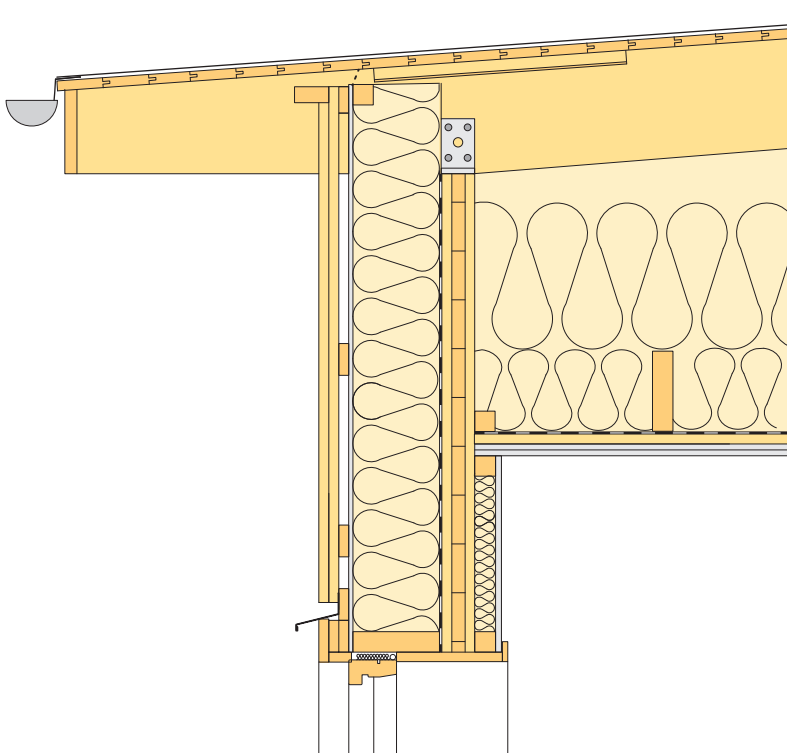

Figure 6.18 Example of connection and fixing to rafters.

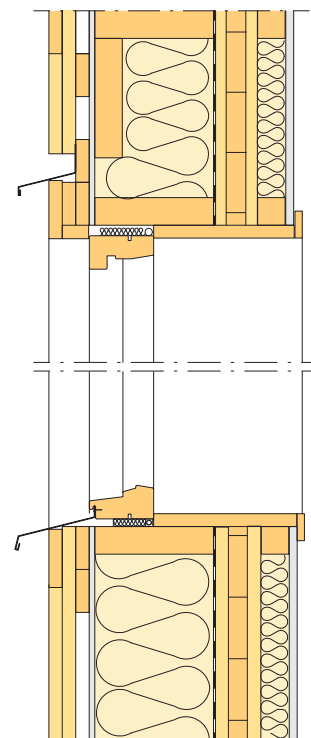

Figure 6.19 Design principle for window mounting.

in the CLT panel or attaching an external frame or angle bracket to the CLT panel so that a window can be mounted on that. Windows and doors can be fitted in the traditional way, usually following the connection instructions set out in AMA Hus and RA Hus. The vapour retarder is sandwiched against the retainer strip and supplemented in the reveal. The seal is supplemented internally with sealant.

A drop apron is fitted against the wooden supporting frame. The nailing battens and the horizontal stud below the window sill are positioned so that the window flashing has a good slope on it.

6.7.5 Connections external wall corners

A load-bearing CLT frame offers extensive options when it comes to designing the structure of external corners. Supplementary studs and insulation may be added on site or prefabricated together with the load-bearing CLT panel. The wind protection is screwed or clamped into place against the studs.

6.8 Example calculations

6.8.1 Wall panel with openings – control of buckling

Background:

A vertically loaded external wall on the ground floor of a two-storey building has a height $l_e = 2.95$ m and a width $b_0 = 4.54$ m. The wall has two windows and the effective wall width without windows is $b_{ef} = 2.40$ m, see figure 6.21 and figure 6.22, page 128.

The design load from the roof, the wall and the floor structure above the wall is $F_d = 30$ kN/m. Wind pressure across the wall is $q_d = 2.4$ kN/m². The wall comprises a 3-layer panel of CLT, thickness $3 \times 30 = 90$ mm, with all the layers of boards meeting strength class C24. Service class 1, safety class 3 ($\gamma_d = 1$).

For CLT with boards only of strength class C24, the following applies, in line with table 3.7, page 38:

$$\begin{aligned} E_{0,x,0.05} &= 7,400 \text{ MPa} \\ E_{0,x,\text{mean}} &= 11,000 \text{ MPa} \\ G_{9090,x,\text{lay,mean}} &= 50 \text{ MPa} \\ G_{090,x,\text{lay,mean}} &= 690 \text{ MPa} \end{aligned}$$

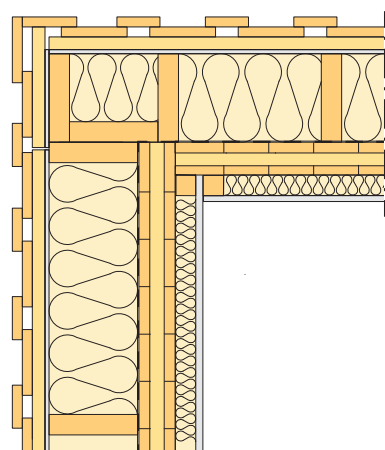

Figure 6.20 Design principle for corners of external walls, horizontal cross-section.

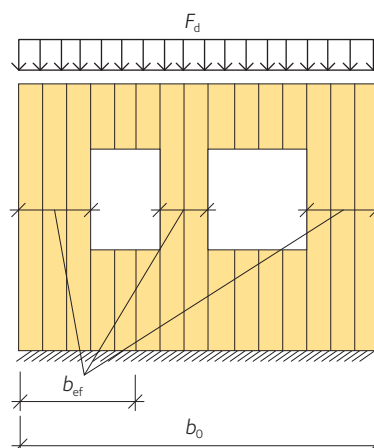

Figure 6.21 Wall panel with openings.

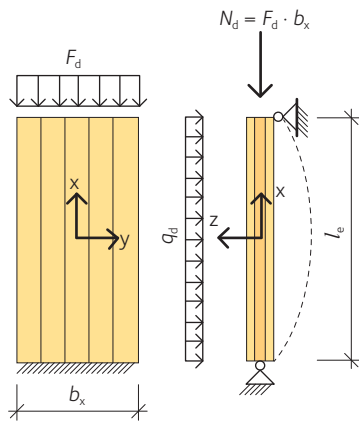

Figure 6.22 Part of a wall panel.

Using table 3.6, page 38 the following applies:

$$f_{m,k} = 24 \text{ MPa}$$

$$f_{c,0,k} = 21 \text{ MPa}$$

With $\gamma_M = 1.25$ as in table 3.2, page 35, and $k_{mod} = 0.9$ as in table 3.3, page 36 (wind load leading action = short-term load), the design strengths are:

$$f_{m,d} = \frac{k_{mod} \cdot f_{m,k}}{\gamma_M} = \frac{0.9 \cdot 24}{1.25} = 17.28 \text{ MPa}$$

$$f_{c,0,d} = \frac{k_{mod} \cdot f_{c,0,k}}{\gamma_M} = \frac{0.9 \cdot 21}{1.25} = 15.12 \text{ MPa}$$

Calculations:

Cross-sectional dimensions for different sizes of 3-layer CLT panels can be found in table 3.11, page 45 and in table 3.13, page 47 for CLT panels with boards in strength class C24. Cross-sectional properties can also be calculated for a strip $b_x = 1.0$ m of the board, see table 6.9. Buckling is checked in the ultimate limit state:

$$\frac{\sigma_{c,0,d}}{k_{c,y} \cdot f_{c,0,d}} + \frac{\sigma_{m,d}}{f_{m,d}} \leq 1$$

Table 6.9 Properties of 3-layer symmetrical CLT panel, strip of width $b_x = 1.0$ m. Panel thickness 90 mm (30/30/30).

Property	Calculation formula	Application in example
Centre of gravity (mm)	$z_s = \frac{h_{CLT}}{2}$	$z_s = \frac{90}{2} = 45 \text{ mm}$
Cross-section area (mm ²)	$A_{x,net} = b_x \cdot 2 \cdot t_1$	$A_{x,net} = 1000 \cdot 2 \cdot 30 = 600 \cdot 10^2 \text{ mm}^2$
Net moment of inertia (mm ⁴)	$I_{x,net} = b_x \left(\frac{t_1^3}{12} + t_1 a_1^2 + \frac{t_3^3}{12} + t_3 a_3^2 \right) = b_x \left(2 \cdot \frac{t_1^3}{12} + 2 \cdot t_1 a_1^2 \right)$	$I_{x,net} = 1000 \left(2 \cdot \frac{30^3}{12} + 2 \cdot 30 \cdot 30^2 \right) = 5850 \cdot 10^4 \text{ mm}^4$
Net moment of resistance (mm ³)	$W_{x,net} = \frac{I_{x,net}}{z_s}$	$W_{x,net} = \frac{5850 \cdot 10^4}{45} = 1300 \cdot 10^3 \text{ mm}^3$
Gamma values	$\gamma_1 = 1; \quad \gamma_3 = \frac{1}{1 + \frac{\pi^2 E_{x,3} t_3}{l_e^2} \frac{t_2}{G_{9090,2}}}$	$\gamma_1 = 1; \quad \gamma_3 = \frac{1}{1 + \frac{\pi^2 11000 \cdot 30}{2950^2} \frac{30}{50}} = 0.817$
Effective moment of resistance (mm ⁴)	$I_{x,ef} = \frac{b_x t_1^3}{12} + b_x t_1 a_1^2 + \frac{b_x t_3^3}{12} + \gamma_3 b_x t_3 a_3^2 = b_x \cdot \left(\frac{2 \cdot t_1^3}{12} + (1 + \gamma_3) t_1 a_1^2 \right)$	$I_{x,ef} = 1000 \cdot \left(\frac{2 \cdot 30^3}{12} + (1 + 0.817) \cdot 30 \cdot 30^2 \right) = 5356 \cdot 10^4 \text{ mm}^4$
Effective radius of gyration $i_{0,ef}$	$i_{x,ef} = \sqrt{\frac{I_{x,ef}}{A_{x,net}}}$	$i_{x,ef} = \sqrt{\frac{5356 \cdot 10^4}{600 \cdot 10^2}} = 29.87 \text{ mm}$
Slenderness factor λ_y	$\lambda_y = \frac{l_e}{i_{x,ef}}$	$\lambda_y = \frac{2950}{29.87} = 98.8$

Reduction factor $k_{c,y}$ can be expressed as:

$$k_{c,y} = \frac{1}{k_y + \sqrt{k_y^2 - \lambda_{rel,y}^2}} = \frac{1}{1.971 + \sqrt{1.971^2 - 1.675^2}} = 0.332$$

where:

$$k_y = 0.5 \left(1 + 0.1 (\lambda_{rel,y} - 0.3) + \lambda_{rel,y}^2 \right) = 0.5 \left(1 + 0.1 (1.675 - 0.3) + 1.675^2 \right) = 1.971$$

where:

$$\lambda_{rel,y} = \frac{\lambda_y}{\pi} \sqrt{\frac{f_{c,0,k}}{E_{0,05}}} = \frac{98.8}{\pi} \sqrt{\frac{21}{7400}} = 1.675$$

Openings in the wall cause larger loads on the remaining sections of the wall. As a rule, it is possible to assume an evenly spread load on the wall sections between the windows. Loads are distributed to the effective width b_{ef} with factor f_b :

$$f_b = \frac{b_0}{b_{ef}} = \frac{4.54}{2.40} = 1.89$$

The vertical load is calculated for a 1.0 m strip of effective width b_{ef} :

$$N_d = b_x \cdot f_b \cdot P_d = 1.0 \cdot 1.89 \cdot 30 = 57 \text{ kN}$$

Moment of the wind load:

$$M_{y,d} = \frac{q_d \cdot l_e^2}{8} = \frac{2.4 \cdot 1.89 \cdot 2.95^2}{8} = 4.93 \text{ kNm}$$

$$\frac{\sigma_{c,0,d}}{k_{c,y} \cdot f_{c,0,d}} + \frac{\sigma_{m,d}}{f_{m,d}} = \frac{N_d}{k_{c,y} \cdot A_{x,net} \cdot f_{c,0,d}} + \frac{M_{y,d}}{W_{x,net} \cdot f_{m,d}} =$$

$$\frac{57 \cdot 10^3}{0.332 \cdot 600 \cdot 10^2 \cdot 13.44} + \frac{4.93 \cdot 10^6}{1300 \cdot 10^3 \cdot 15.36} = 0.213 + 0.247 = 0.460 \leq 1 \quad \text{OK}$$

The wall can handle the stresses from the compression and moment, with a capacity utilisation of 46 percent.

6.8.2 Beam over opening, supported by posts

With a reducing span to height ratio, linear stress distribution under beam theory no longer applies. Non-linear behaviour becomes noticeable in wall beams with around $l/h \leq 4$, and must be taken into account at $l/h \leq 2$. Edge stresses when calculating using plate theory depend on the load on the upper and lower sections of the panel and on the l/h ratio.

In continuous systems, the shear deformation affects the internal forces. The moment at the supports reduces and the moment in the midfield increases. It is therefore recommended that moment and bending stresses are determined based on a simply supported beam along the longest span. Reaction forces and shear forces can be determined based on a continuous beam.



Portvaktén, Växjö, Sweden.

Table 6.10 Loads and load factors.

Last	kN/m ²	γ_d, γ_Q	Duration class	k_{mod}	ψ_0	ψ_1	ψ_2
g_k	11.7	0.89 · 1.35	Permanent (P)	0.6	-	-	-
n_k	6.00	1.5	Medium (M)	0.8	0.7	0.5	0.3
s_k	3.50	1.5	Medium (M)	0.8	0.8	0.6	0.2

Background:

A vertically and horizontally loaded wall panel, with two spans of lengths $l_1 = 4.5$ m and $l_2 = 6.5$ m and height $h = 3$ m, see figure 6.23.

Loads:

- The self-weight from the roof above the wall is $g_k = 4.0$ kN/m and from the wall and floor structure along the lower edge it is $g_k = 7.7$ kN/m.
- The imposed load acting on the lower edge is $n_k = 6.0$ kN/m.
- The snow load acting on the upper edge is $s_k = 3.5$ kN/m.
- Loads and load factors as in table 6.10.

The wall comprises a 5-layer CLT panel with a thickness of $30 + 20 + 30 + 20 + 30 = 130$ mm and with all the boards in strength class C24. Service class 1, safety class 3 ($\gamma_d = 1$).

For CLT with boards only of strength class C24, the following applies, in line with table 3.7, page 38:

$$E_{0,x,0.05} = 7\,400 \text{ MPa}$$

$$E_{0,x,mean} = 11\,000 \text{ MPa}$$

$$G_{9090,x,lay,mean} = 50 \text{ MPa}$$

$$G_{090,x,lay,mean} = 650 \text{ MPa}$$

According to table 3.6, page 38:

$$f_{m,k} = 24 \text{ MPa}$$

$$f_{c,0,k} = 21 \text{ MPa}$$

$$f_{v,k} = 4 \text{ MPa}$$

With $\gamma_M = 1.25$ in line with table 3.2, page 35 and $k_{mod} = 0.8$ in line with table 3.3, page 36 (imposed load leading action = medium term), the design strengths become:

$$f_{m,d} = \frac{k_{mod} \cdot f_{m,k}}{\gamma_M} = \frac{0.8 \cdot 24}{1.25} = 15.36 \text{ MPa}$$

$$f_{c,0,d} = \frac{k_{mod} \cdot f_{c,0,k}}{\gamma_M} = \frac{0.8 \cdot 21}{1.25} = 13.44 \text{ MPa}$$

$$f_{v,d} = \frac{k_{mod} \cdot f_{v,k}}{\gamma_M} = \frac{0.8 \cdot 4}{1.25} = 2.56 \text{ MPa}$$

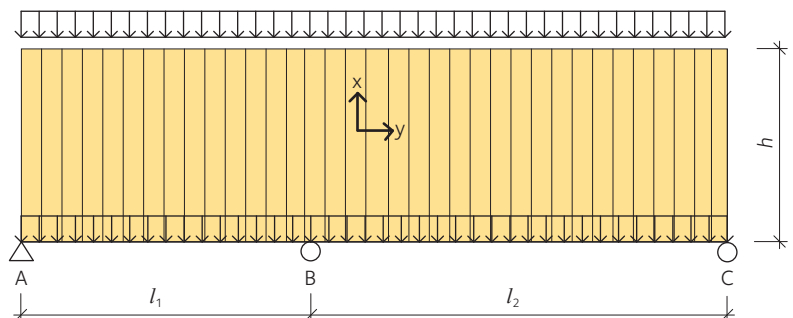

Figure 6.23 Wall panel on supporting posts.

Calculations:

Design load combination for vertical load:

$$q_d = \gamma_G \cdot g_k + \gamma_{Q,n} \cdot n_k + \gamma_{Q,s} \cdot \Psi_{0,s} \cdot s_k =$$

$$0.89 \cdot 1.35 \cdot 11.7 + 1.5 \cdot 6.00 + 1.5 \cdot 0.8 \cdot 3.5 = 27.3 \text{ kN/m}$$

MomentDesign moment for a single-span beam of length $l_2 = 6.5 \text{ m}$:

$$M_d = \frac{q_d \cdot l_2^2}{8} = \frac{27.3 \cdot 6.5^2}{8} = 144.2 \text{ kNm}$$

The cross-section during bending is calculated for the horizontal layers, i.e. only the layers of boards in the bearing direction:

$$W_{z,\text{net}} = \frac{d_z \cdot h^2}{6} = \frac{0.04 \cdot 3^2}{6} = 0.06 \text{ m}^3$$

with d_z = total board thickness for the horizontal layers:

$$\sigma_d = \frac{M_d}{W_{z,\text{net}}} = \frac{144.2 \cdot 10^3}{0.06 \cdot 10^6} = 2.40 \text{ MPa} < f_{m,d} = 15.36 \text{ MPa}$$

Shear force

Design shear force:

$$V_d = 0.625 \cdot q_d \cdot l_2 = 0.625 \cdot 27.3 \cdot 6.5 = 110.9 \text{ kN}$$

$$A_{z,\text{net}} = d_z \cdot h = 0.04 \cdot 3 = 0.12 \text{ m}^2$$

with d_z = total board thickness for the horizontal layers::

$$\tau_d = 1.5 \cdot \frac{V_d}{A_{z,\text{net}}} = 1.5 \cdot \frac{110.9 \cdot 10^3}{0.12 \cdot 10^6} = 1.38 \text{ MPa} < f_{v,d} = 2.56 \text{ MPa}$$

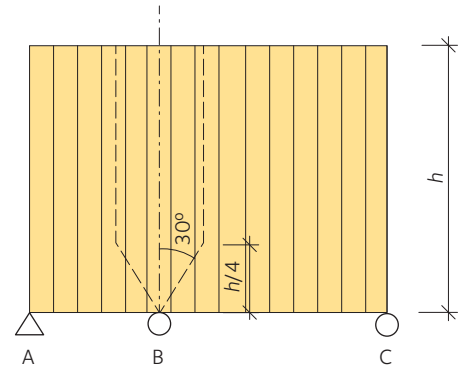
**Figure 6.24** Load spread from support reaction.**Table 6.11** Properties of 5-layer symmetrical CLT panel, strip of width $b_x = 1.0 \text{ m}$. Panel thickness 130 mm (30/20/30/20/30).

Property	Calculation formula	Application to example
Cross-section area (mm ²)	$A_{x,\text{net}} = b_x \cdot 3 \cdot t_1$	$A_{x,\text{net}} = 1000 \cdot 3 \cdot 30 = 900 \cdot 10^2 \text{ mm}^2$
Gamma values	$\gamma_3 = 1 \quad \gamma_1 = \gamma_5 = \frac{1}{1 + \frac{\pi^2 E_{x,3} t_3}{l_{\text{ref}}^2} \cdot \frac{t_4}{G_{9090,4}}}$	$\gamma_3 = 1 \quad \gamma_1 = \gamma_5 = \frac{1}{1 + \frac{\pi^2 11000 \cdot 30}{3000^2} \cdot \frac{20}{50}} = 0.874$
Effective moment of resistance (mm ⁴)	$I_{x,\text{ef}} = \frac{b_x t_1^3}{12} + \gamma_1 b_x t_1 a_1^2 + \frac{b_x t_3^3}{12} + \frac{b_x t_5^3}{12} + \gamma_5 b_x t_5 a_5^2 = b_x \cdot \left(\frac{3 \cdot t_1^3}{12} + 2\gamma_1 t_1 a_1^2 \right)$	$I_{x,\text{ef}} = 1000 \cdot \left(\frac{3 \cdot 30^3}{12} + 2 \cdot 0.874 \cdot 30 \cdot 50^2 \right) = 13785 \cdot 10^4 \text{ mm}^4$
Radius of gyration $i_{x,\text{ef}}$	$i_{x,\text{ef}} = \sqrt{\frac{I_{x,\text{ef}}}{A_{x,\text{net}}}}$	$i_{x,\text{ef}} = \sqrt{\frac{13785 \cdot 10^4}{900 \cdot 10^2}} = 39.1 \text{ mm}$
Slenderness factor λ_y	$\lambda_y = \frac{l_k}{i_{x,\text{ef}}}$	$\lambda_y = \frac{3000}{39.1} = 76.7$



Interior with CLT and glulam beams.

Compressive force

Load spreading from supports is calculated for an angle of 30° out from the support up to the height $h/4$.

Support reaction:

$$M_B = -\frac{q_d l_1^3 + q_d l_2^3}{8(l_1 + l_2)} = \frac{27.3 \cdot 4.5^3 + 27.3 \cdot 6.5^3}{8(4.5 + 6.5)} = 113 \text{ kNm}$$

$$R_B = \frac{q_d l_1}{2} + \frac{q_d l_2}{2} - \frac{M_B}{l_1} - \frac{M_B}{l_2} = \frac{27.3 \cdot 4.5}{2} + \frac{27.3 \cdot 6.5}{2} - \frac{113}{4.5} - \frac{113}{6.5} = 193 \text{ kN}$$

Load spreading:

$$B = 2 \cdot \frac{h}{4} \cdot \tan(30^\circ) = 2 \cdot \frac{3}{4} \cdot 0.577 = 0.86 \text{ m}$$

This means that the load reaction spreads to a width of 0.86 m with a force of:

$$n_d = \frac{R_B}{B} = \frac{193}{0.86} = 224 \text{ kN/m}$$

Checks on buckling are made for a strip of 1.0 m, which gives the force:

$$n_{1,d} = \frac{n_d}{B} = \frac{224}{0.86} = 260 \text{ kN/m}$$

Control of buckling

The properties of the 5-layer panel are set out in *table 6.11, page 131*.

Buckling is checked in the ultimate limit state:

$$\frac{\sigma_{c,0,d}}{k_{c,y} \cdot f_{c,0,d}} \leq 1$$

Reduction factor $k_{c,y}$ can be expressed as:

$$k_{c,y} = \frac{1}{k_y + \sqrt{k_y^2 - \lambda_{rel,y}^2}} = \frac{1}{1.395 + \sqrt{1.395^2 - 1.30^2}} = 0.526$$

where:

$$k_y = 0.5 \left(1 + 0.1(\lambda_{rel,y} - 0.3) + \lambda_{rel,y}^2 \right) = 0.5 \left(1 + 0.1(1.30 - 0.3) + 1.30^2 \right) = 1.395$$

where:

$$\lambda_{rel,y} = \frac{\lambda_y}{\pi} \sqrt{\frac{f_{c,0,k}}{E_{0,05}}} = \frac{76.7}{\pi} \sqrt{\frac{21}{7400}} = 1.30$$

$$\sigma_{c,0,d} = \frac{n_{1,d}}{A_{x,net}} = \frac{260 \cdot 10^3}{900 \cdot 10^2} = 2.88 \text{ MPa}$$

$$\frac{\sigma_{c,0,d}}{k_{c,y} \cdot f_{c,0,d}} = \frac{2.88}{0.526 \cdot 13.44} = 0.41 \leq 1 \quad \text{OK}$$

The wall is able to handle the compressive force, with a capacity utilisation of 41 percent.

CLT and fire safety

Since the mid-1990s, there has been a transition to functional requirements in fire safety regulations. This has been sparked by extensive studies that have increased knowledge of fire safety behaviour in wooden materials and wooden structures. Wooden structures can now be designed for fire safety using new calculation models.

7.1 Wood and fire safety

If an exposed non-fire-retardant-treated wooden surface is exposed to the effects of fire, it will ignite. The burning then continues inwards, but at a largely constant speed. The penetration rate is slow since the char layer that forms provides thermal insulation and combats the heat flow from the source of the fire to the pyrolysis zone. The pyrolysis zone is subject to temperatures of between around 250 °C and 350 °C and it is here that flammable gases are formed and then diffuse through the char layer until they encounter oxygen on the surface and begin to burn. A clear boundary forms between the char layer and the residual cross-section at 300 °C, see figure 7.1. The penetration of the burning is greater at wide splits and external corners. The wood's good properties in a fire are mainly because it "protects itself" via the char layer, but sometimes extra cladding is required to provide additional fireproofing.

The temperature in the unburned parts of a large-scale wooden structure remain largely unaffected even under prolonged exposure to fire.

Temperatures more than 100 °C only occur in a narrow zone around 10 mm deep immediately beneath the char layer, but strength and stiffness are significantly lower there than in the unaffected wood.

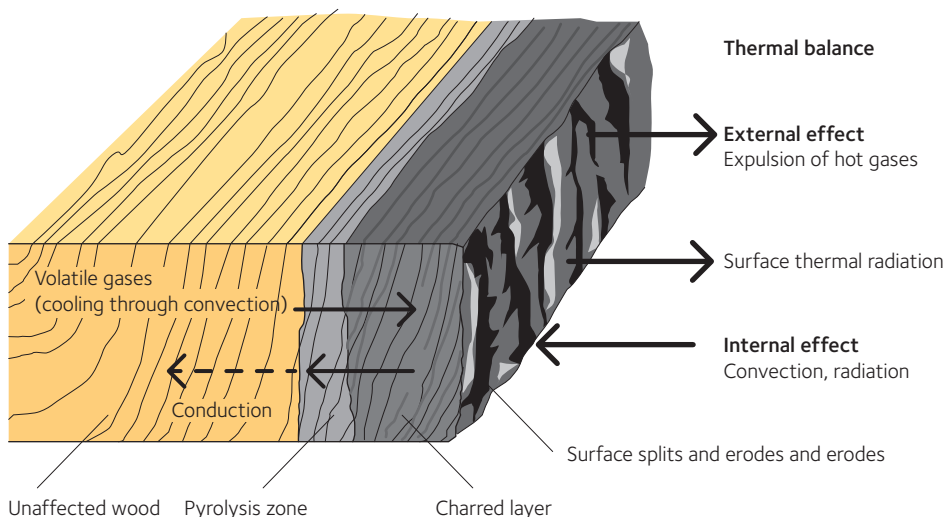

Figure 7.1 The phenomenon of the charring process.

7.1 Wood and fire safety 133

- 7.1.1 Fire safety in buildings – two key phases 134
- 7.1.2 Fire safety requirements in building regulations 135
- 7.1.3 Design loads in event of fire 136

7.2 Fire resistance in CLT 138

- 7.2.1 Charring 138
- 7.2.2 Effective cross-section 138

7.3 Details 140

- 7.3.1 Conduits 140

7.4 Example calculations 141

- 7.4.1 Unprotected floor slab 141
- 7.4.2 Protected floor slab 142
- 7.4.3 Unprotected wall panel 143
- 7.4.4 Protected wall panel 143

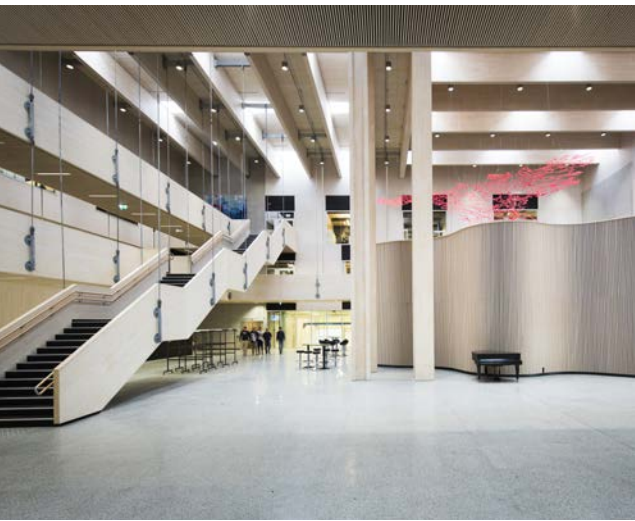

Nordoster school, Norway.

During a fire, a large proportion of the heat is transferred via mass transfer primarily through diffusion of fire gases. When these gases move inwards, the temperature rises until the wood begins to decompose and char, while the gases in the charred zone dampen the temperature rise in the glowing char layer. Just before the charred layer is a layer where the temperature is not high enough for charring to occur, but the properties of the wood are nevertheless affected. Standard SS-EN 1995-1-2 suggests a reduction in the wood material's mechanical properties by introducing reduction coefficients, but this method is not recommended. Instead the reduced cross-section method in SS-EN 1995-1-2 should be used.

Methods for calculating the fire resistance of CLT are not included in the current version of SS-EN 1995-1-2, but will appear in the next version, based in part on the European handbook *Fire Safety in Timber Buildings*, see section 7.2, page 138.

Metallic fasteners such as nails, wood screws, dowels and so on can contribute to a higher thermal flow in the wood and increase burning.

7.1.1 Fire safety in buildings – two key phases

There are two key phases for fire in buildings, the initial course of the fire, with its related requirements concerning surface materials, and the fully developed fire and the associated requirements relating to the structural frame, see figure 7.2.

In the initial phase of the fire, the building's contents, i.e. furniture and fittings, have the greatest significance, but these are not regulated in building standards. Surface materials on walls and ceilings can help, particularly in evacuation routes and similar spaces where loose items should not be present. Restrictions on the use of combustible surface materials in evacuation routes can therefore be found in most countries' building standards. Once a fire has fully developed, i.e. flashover has occurred in a room, the fire resistance of the walls and floor structure become important in limiting the fire to the place of origin. Wooden structures can achieve high fire resistance, although the fire behaviour of exposed wooden surfaces does not meet the highest fire safety requirements.

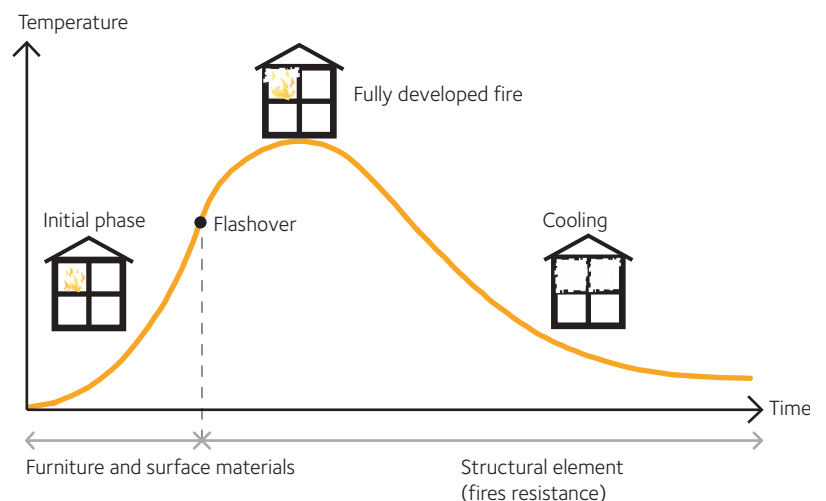

Figure 7.2 Fire development in buildings includes two main phases, the initial fire with its requirements concerning the fire safety properties of surface materials, and the fully developed fire, with its related requirements concerning the fire resistance of structural elements.

7.1.2 Fire safety requirements in building regulations

Fire safety requirements for buildings relate to both surface materials and the structural frame.

General requirements

Fire safety in buildings must be planned, implemented and verified based on simplified or analytical design methods. Simplified design means that the developer meets the regulations via the solutions and methods stated in the Swedish Boverket's Building Regulations (BBR). Analytical design means that the developer meets the regulations in some other way and verifies this by conducting a qualitative assessment, scenario analysis or quantitative risk analysis.

The requirements that apply to a building are determined by building classes Br 0 – Br 3 for entire buildings and depend primarily on the evacuation options and how great a risk there is of serious personal injury in the event of a fire occurring. Factors such as the building's size, number of floors and use, for example housing, affects the building class. Building classes Br 0 – Br 3 are defined in BBR based on fire protection needs, *see table 7.1*.

There is also a division of buildings into occupancy classes 1 – 6 that must be considered.

Fire safety requirements concerning frame and structural elements

Structural elements must meet the following fire safety functions:

- R Load-bearing capacity
- E Integrity (airtightness)
- I Insulation.

The designations can be combined and accompanied by a time requirement: 15, 30, 60, 90, 120, 180, 240 or 360 minutes. The figures state the time in minutes that the building component must be able to resist the effect of a standard fire, without losing its load-bearing and separating function. A load-bearing separating wall may, for example, need to meet requirement REI 60, which means that it needs to resist a standard fire for 60 minutes regarding all three functions.

Where the structure needs to handle a mechanical impact, the classification will include the letter M. The designation REI 90-M thus states that the structure can handle the mechanical effect while at the same time meeting the load-bearing, integrity and temperature requirements for 90 minutes for a standard fire. The structure's mechanical strength is determined by the occupancy of the premises, with CLT able in most cases to meet the set requirements simply with the dimensions achieved when designing in the fire load case.

According to national Swedish regulations, load-bearing structures must be designed so that there is a comfortable safety margin against failure even during exposure to fire. This is proven by calculating the load-bearing capacity under realistic conditions relating, for example, to the temperature progression (known as the natural fire method). Calculation methods for natural fires are complex for structures and so a simplified and standardised method is used, where the temperature time curve follows a given reference (standard fire exposure). The support structure is thus built up of fire safety classified elements designed for standard fire exposure of different durations, in accordance with national regulations.



Sporthall, Svenljunga, Sweden.

Table 7.1 Building classes as defined in BBR based on fire protection needs.

Building class	Definition
Br 0	Buildings with extremely high fire protection requirements, new class introduced in 2012. Building > 16 storeys must be designed analytically.
Br 1	Buildings with high fire protection requirements, primarily buildings > 2 storeys.
Br 2	Buildings with moderate fire protection requirements, primarily buildings with 1 – 2 storeys.
Br 3	Buildings with low fire protection requirements, primarily single-storey buildings.



CLT at the manufacturer.

Fire safety requirements for building products

A surface is defined as the visible outer part of a building's structure or component that may be exposed in a fire's early phase, with the surface class indicating the capacity to prevent or delay flashover and development of smoke. The surface may be an untreated wooden surface.

Building construction materials are divided into European fire safety classes, see table 7.2. Examples of fire safety classes for certain construction materials are also shown in the table.

Class B is the highest class that can be achieved for combustible products and class D equates to the properties of untreated wood cladding.

Ceilings in fireproof buildings (building class Br 1) should have a surface material of class B and walls of class C. Fire resistant buildings (building class Br 2) should have surface materials in class C for the ceiling and class D on the walls. In both cases, ceilings should have a substrate in a non-combustible material, such as gypsum plasterboard or some other non-combustible sheet material.

Surface material class D can be used primarily in building class Br 3, for example a single-family house. Other building classes require a surface material of class B or C, which can be achieved with fire retardant treatment. However, if the building has a sprinkler system, a class D surface material can also be used in taller and larger buildings. In addition, this offers extremely safe accommodation, since sprinklers allow time for evacuation and thus save lives.

Floorings have similar European fire safety classes, ranging from A_{fl} – F_{fl} . Spruce mass timber floors can achieve class C_{fl} , while the class for pine is D_{fl} .

7.1.3 Design loads in event of fire

The design load for a structural element in the fire load case is the accidental load, and the structure's load-bearing capacity in a fire must be verified for every element by meeting the criterion in equation 7.1:

$$7.1 \quad A_{d,f}(t) \leq R_{d,f}(t)$$

where:

- $A_{d,f}$ is the design value for a load in a fire.
- $R_{d,f}$ is the load-bearing capacity under the same conditions.
- t is the duration of the fire's effect.

Table 7.2 European surface material classes excluding floorings.

Main class	Smoke class	Droplet class	Requirements relate to			FIGRA (W/s)	Examples of products
			Non-combustible	SBI	Low flammability		
A1	–	–	x	–	–	–	Stone, glass, steel
A2	s1, s2 or s3	d0, d1 or d2	x	x	–	≤ 120	Plasterboard (thin paper), mineral wool
B	s1, s2 or s3	d0, d1 or d2	–	x	x	≤ 120	Plasterboard (thick paper), fireproofed wood
C	s1, s2 or s3	d0, d1 or d2	–	x	x	≤ 250	Wallpaper on plasterboard, fireproofed wood
D	s1, s2 or s3	d0, d1 or d2	–	x	x	≤ 750	Wood, CLT and wood-based panels
E	–	– or d2	–	–	x	–	Certain synthetic materials
F	–	–	–	–	–	–	No fire safety class decided

SBI = Single Burning Item, SS-EN 13823, main method for surface materials excluding floorings.
 FIGRA = Fire Growth Rate, key parameter for fire safety classes using the SBI method.

When designing in the fire load case, use the load combination in equation 7.2, in line with Eurocode 0 and EKS 10:

$$G_k + \psi_{1,1}Q_{k,1} + \sum_{i=1}^n \psi_{2,i}Q_{k,i}$$

where:

- G_k is the characteristic value for permanent actions.
- $Q_{k,1}$ is the characteristic value for the leading variable action.
- $Q_{k,i}$ is the characteristic value for the other variable actions.
- $\psi_{1,1}$ is the combination factor for the leading variable action.
- $\psi_{2,1}$ is the general combination factor for the other variable actions.

The combination factors ψ are determined by the different load categories of the structural elements and they usually range between 0 and 0.7. The choice of combination factor must be given consideration if the structural element's maximum load can be expected to occur in a fire situation, such as in a library, archive or warehouse.

A simplified method is to verify the structure's load-bearing capacity in the fire load case based on a reduced load, as set out in SS-EN 1995-1-2, section 2.4.2, where the load effect in a fire $s_{d,fi}$ for an individual structural element is calculated using equation 7.3:

$$E_{d,fi} = \eta_{fi} E_d$$

where:

- E_d is the design load effect when designing for normal temperature.
- η_{fi} is the reduction factor for design load in a fire depending on the load ratio $\zeta = Q_{k,1}/G_k$ and the combination factor ψ_{fi} for frequent values for variable actions. The recommended figure for general calculations is $\eta_{fi} = 0.6$. Under an imposed load in category E as set out in Eurocode 1 (areas susceptible to accumulation of goods, including access areas), the recommended value is $\eta_{fi} = 0.7$. The reduction factor η_{fi} can be lower for lightweight floor structures.

For mechanical load-bearing capacity in the fire load case, the design values for strength and stiffness are to be determined using equations 7.4 – 7.7:

$$f_{d,fi} = k_{mod,fi} \frac{f_{20}}{\gamma_{M,fi}} \quad S_{d,fi} = k_{mod,fi} \frac{S_{20}}{\gamma_{M,fi}} \quad 7.4, 7.5$$

$$f_{20} = k_{fi} f_k \quad S_{20} = k_{fi} S_{05} \quad 7.6, 7.7$$

where:

- $f_{d,fi}$ is the design strength in a fire.
- $S_{d,fi}$ is the design stiffness in a fire.
- f_{20} is the 20 % fractile strength at normal temperature.
- S_{20} is the 20 % fractile stiffness at normal temperature.
- $k_{mod,fi}$ is the load duration and moisture modification factor in a fire. Recommended value of 1.0 when using method with reduced cross-section.
- $\gamma_{M,fi}$ is the partial factor for wood in a fire. Recommended value 1.0.
- k_{fi} Factor for converting 5 % fractile to 20 % fractile. For cross laminated wood (CLT), $k_{fi} = 1,15$.

7.2

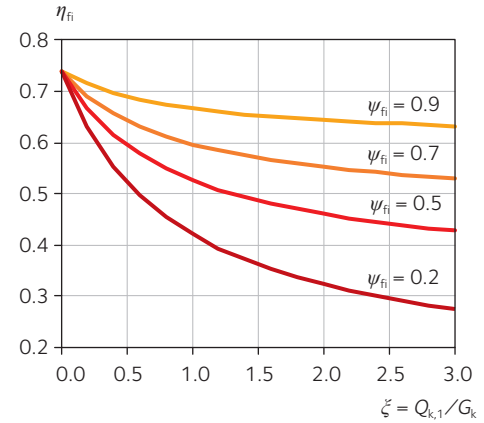
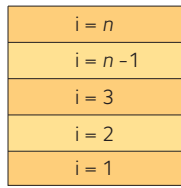

Figure 7.3 Examples of variation in reduction factor η_{fi} with load ratio $\zeta = Q_{k,1}/G_k$.

7.3

7.2 Fire resistance of CLT



a) Cross-section at normal temperature.

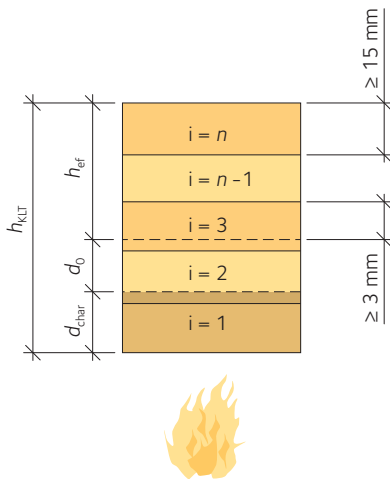

b) Residual cross-section $h_{\text{ef, char}}$ layer d_{char} and non-load-bearing layer d_0 for single-sided fire exposure.

Figure 7.4 CLT cross-section.

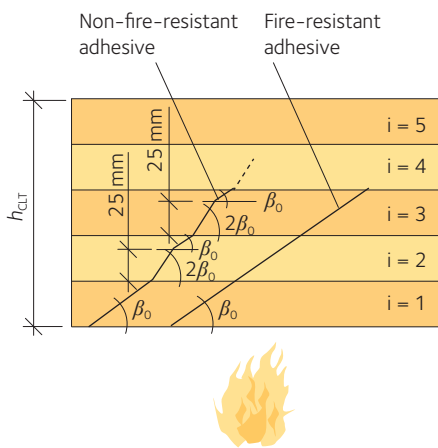

Figure 7.5 Charring of CLT with non-fire-resistant adhesive (with delamination) and fire-resistant adhesive (no delamination).

For CLT panels that comprise an odd number of layers of set thicknesses, the connections between two layers are assumed to be able to transfer shear forces under the effect of fire. When modelling CLT panels regarding bending, the outer layers and layers parallel with the outer layers are usually considered to be load-bearing. Transverse layers are not considered directly load-bearing, but they help to transfer shear forces between the layers in the longitudinal direction.

A fire safety calculation method for CLT is not included in SS-EN 1995-1-2. The European handbook Fire Safety in Timber Buildings applies the effective cross-section method to calculate fire resistance in CLT structures. In this method, account is taken of the reduction in strength of the non-load-bearing layers in a fire. Thermal simulation and testing of CLT in a fire shows that the non-load-bearing layer in CLT is not constant. The principles for a simplified model for various cross-sections are presented in figures 7.4 a) and b).

7.2.1 Charring

If a layer of cross laminated timber, (CLT) is made up of edge-glued boards or if the gap between two boards is less than 2 mm, one-dimensional charring should be used, as set out in equation 7.8:

$$7.8 \quad d_{\text{char},0} = \beta_0 t$$

where:

- β_0 is 0.65 mm/min and is a one-dimensional charring rate in a standard fire.
- t is the fire exposure time.

If the gaps between the boards are greater than or equal to 2 mm, but less than 6 mm, a notional charring rate should be used, as set out in equation 7.9:

$$7.9 \quad d_{\text{char},n} = \beta_n t$$

According to SS-EN 1995-1-2, table 3.1 notional charring rates for wood with a rectangular cross-section that is exposed to fire on three or four sides can be set at:

- β_n is 0.7 mm/min for softwood glulam and LVL.
- β_n is 0.8 mm/min for softwood construction timber (CLT).
- β_n is the equivalent design charring rate, which includes the effect of rounded corners and splits.

There are two possible scenarios for charring of CLT. With a melamine-urea-formaldehyde (MUF) adhesive (with no delamination), the charring occurs at a rate of β_0 in the same way as for construction timber. With some polyurethane (PUR) adhesives (with delamination), the charring rate for the first 25 mm of each board is doubled, giving $2\beta_0$, see figure 7.5.

7.2.2 Effective cross-section

The design method for load-bearing capacity as presented below follows the general principles in the method for a reduced cross-section, whereby the original cross-section is reduced by an effective charring depth d_{er} . The effect of temperature increases on the material's prop-

erties is considered by part of the cross-section, d_0 , not being included in the effective residual cross-section, h_{ef} . See equations 7.10 and 7.11:

$$d_{ef} = d_{char,0} + d_0 \quad 7.10$$

or:

$$d_{ef} = d_{char,n} + d_0 \quad 7.11$$

Tables 7.3 – 7.5 contain several formulae for the non-load-bearing layer d_0 which are based on test results and thermal simulations.

Table 7.3 Non-load-bearing layer, d_0 , for $t = 0 - 120$ minutes for CLT panel with 3 layers.

Fire on	Floor slab		Wall panel	
	Unprotected surface (mm)	Protected surface ¹⁾ (mm)	Unprotected surface (mm)	Protected surface ¹⁾ (mm)
Panel's side under tension	$d_0 = \frac{h_{CLT}}{30} + 3.7$	$d_0 = 10$	Not relevant	Not relevant
Panel's side under compression	$d_0 = \frac{h_{CLT}}{25} + 4.5$	$d_0 = \min \begin{cases} 13.5 \\ \frac{h_{CLT}}{12.5} + 7 \end{cases}$	$d_0 = \frac{h_{CLT}}{25} + 3.95$	$d_0 = \min \begin{cases} 13.5 \\ \frac{h_{CLT}}{12.5} + 7 \end{cases}$

¹⁾ The values can also be used for $t > t_f$, where t_f is the time when the protection ceases to function, known as the failure time.

Table 7.4 Non-load-bearing layer, d_0 , for $t = 0 - 120$ minutes for CLT panel with 5 layers.

Fire on	Floor slab		Wall panel	
	Unprotected surface (mm)	Protected surface ¹⁾ (mm)	Unprotected surface (mm)	Protected surface ¹⁾ (mm)
Panel's side under tension	$d_0 = \frac{h_{CLT}}{100} + 10$	$75 \text{ mm} \leq h_{CLT} \leq 100 \text{ mm}$ $d_0 = 34 - \frac{h_{CLT}}{4}$ $h_{CLT} > 100 \text{ mm}$ $d_0 = \frac{h_{CLT}}{35} + 6$	Not relevant	Not relevant
Panel's side under compression	$d_0 = \frac{h_{CLT}}{20} + 11$	$d_0 = 18$	$d_0 = \frac{h_{CLT}}{15} + 10.5$	$d_0 = 20$

¹⁾ The values can also be used for $t > t_f$, where t_f is the time when the protection ceases to function, known as the failure time.

Table 7.5 Non-load-bearing layer, d_0 , for $t = 0 - 120$ minutes for CLT panel with 7 layers.

Fire on	Floor slab		Wall panel	
	Unprotected surface (mm)	Protected surface ¹⁾ (mm)	Unprotected surface (mm)	Protected surface ¹⁾ (mm)
Panel's side under tension	$105 \text{ mm} \leq h_{CLT} \leq 175 \text{ mm}$ $d_0 = \frac{h_{CLT}}{6} + 2.5$ $h_{CLT} > 175 \text{ mm}$ $d_0 = 10$	Same as unprotected surface	Not relevant	Not relevant
Panel's side under compression	$105 \text{ mm} \leq h_{CLT} \leq 175 \text{ mm}$ $d_0 = \frac{h_{CLT}}{6} + 2.5$ $h_{CLT} > 175 \text{ mm}$ $d_0 = 13$	Same as unprotected surface	$105 \text{ mm} \leq h_{CLT} \leq 175 \text{ mm}$ $d_0 = \frac{h_{CLT}}{6} + 4.0$ $h_{CLT} > 175 \text{ mm}$ $d_0 = 16$	Same as unprotected surface

¹⁾ The values can also be used for $t > t_f$, where t_f is the time when the protection ceases to function, known as the failure time.



Office building made of CLT, Älta, Sweden.

For CLT used in floor structures, the simplified method has been adapted to the results of simulations, where the best conformity was achieved between 20 percent and 40 percent of the load-bearing capacity at normal temperature for up to 120 minutes in a standard fire.

The equivalent design for walls was performed for the load condition 30 percent of load-bearing capacity.

The method should not be used for fire conditions of longer than two hours. The fire protection effect of cladding (panels and insulation on the side exposed to fire) are considered as set out in SS-EN 1995-1-2. If the remainder of a load-bearing layer is less than 3 mm, it should not be included in the calculation of effective residual cross-section, h_{ef} .

d_0 is determined by:

- No. of layers.
- Thickness of CLT panel.
- Type of stress, tension or compression on the side exposed to fire.
- Temperature gradient beneath char layer, i.e. whether the layer is protected or unprotected.

For CLT panels that are exposed to fire on one side, the values for the thickness of the non-load-bearing layers, d_0 , are taken from tables 7.3 – 7.5, page 139. When exposed to fire, wooden walls bend out from the fire, which means that tensile stresses can only arise on the non-exposed side of the wall, and thus d_0 is only stated for fire exposure on the compressed side. Walls that are exposed to fire on both sides should be designed using test-related base values.

7.3 Design and details

The structural details are important for a wooden building's fire safety. Wooden structures have a predictable behaviour pattern in a fire, but structural details must be carefully designed to ensure the complete fire safety of the building. The features that directly affect building with CLT are usually cavities in walls, eaves and conduits for installations.

When planning and designing against fire, the location of fire barriers must be taken into account, in eaves, in façade cavities, in and around conduits and between apartments. There are a number of different products and systems that can be used as fire barriers. There are sealants for sealing openings and joints around electrical cables and conduits and through fire compartment separating elements such as walls and floors. Most are certified only for non-combustible structures, but many of these products should also be usable in wooden structures, for example fire retardant sealant, fireproofing tape, fireproof collars/wraps, intumescent sleeves, panels and dampers. Details see also *chapter 5.6, page 104*.

7.3.1 Conduits

The choice of sealant should be based on the design of the structural component and the installations that are being channelled through it. CLT is a combustible material and this must be taken into account when designing conduits. Some of the types that can be used include:

- Intumescent pipe sleeves are steel tubes lined with a material that expands when heated.

- Intumescent collars provide a fireproof seal around combustible pipes running through fire compartments and comprise a metal casing with an inner layer of a material that expands and prevents the spread of fire.
- Sealants designed for wood. The fire safety class of the sealant depends on which materials can be combined.
- Fireproof panels are used for large conduits and are often combined with sealants. Fire safety classes EI 60 – EI 120 are available, with the class determined by the thickness of the panels.

Fire testing of cable conduits with sealant in wooden structures has shown that:

- Joints must be completely filled through the full thickness of the element.
- Gaps between cabling and the hole diameter must be sealed.
- For bundles of more than five cables, special systems or non-combustible insulation must be used.
- For smokeproof joints and connections, permanently elastic sealant should be used.

When it comes to larger conduits for ventilation or plumbing installations, the same systems can be used for CLT as for other wood construction systems, see for example *Brandsäkra trähus, version 3* (Fire Resistant Wooden Buildings 3). Toilets, wash basins and floor drains must be plumbed in without compromising fire resistance. Insulation material must be secured in place, so it does not fall down in a fire.



Example of sealed conduits running through a CLT floor structure.

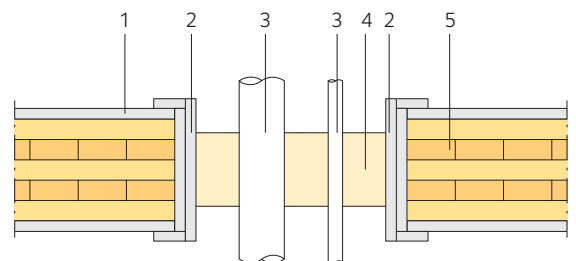

Figure 7.6 Examples of fireproofing.

1. Cladding.
2. Protection board.
3. Conduit.
4. Sealant.
5. CLT.

7.4 Examples

7.4.1 Unprotected floor structure

Design method for a CLT slab used for a floor structure. An unprotected floor slab comprising 7-layer CLT with boards 19 mm thick, exposed to fire from the underside and with less than a 2 mm gap between the boards. Determine the effective slab thickness after 60 minutes of fire exposure.

a) No char ablation (The adhesive used for bonding between laminations is fully effective in fire)

Charring depth after 60 minutes:

$$d_{\text{char},0} = \beta_0 t_{\text{req}} = 0.65 \cdot 60 = 39 \text{ mm}$$

Non-load-bearing layer for fire on side under tension, according to table 7.5, page 139:

$$d_0 = \frac{h_{\text{CLT}}}{6} + 2.5 = \frac{133}{6} + 2.5 = 25 \text{ mm}$$

Effective depth:

$$h_{\text{ef}} = h_{\text{CLT}} - d_{\text{char},0} - d_0 = 133 - 39 - 25 = 69 \text{ mm}$$

Since the effect of the fire reaches in as far as a transverse, non-load-bearing layer (layer 4), the remaining effective residual cross-section will comprise the three layers 5, 6 and 7, see principle in figure 7.7.

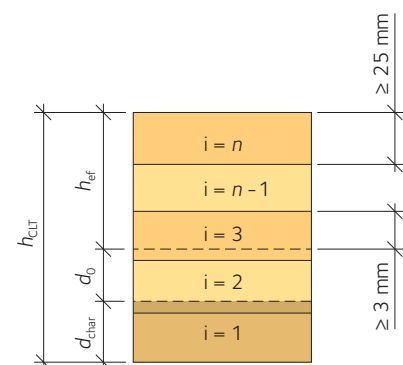

Figure 7.7 Effective cross-section height, h_{ef} .



Limnologen, Växjö, Sweden.

b) Ablation of char layer (char layer not in place)

The failure time for layer 1 is set as equalling the time when layer 2 begins to char:

$$t_{\text{ch}} = t_{f,1} = \frac{h_1}{\beta_0} = \frac{19}{0.65} = 29 \text{ minutes}$$

Charring depth after 60 minutes:

$$d_{\text{char}} = h_1 + (t_{\text{req}} - t_f) \beta_0 k_3 = 19 + (60 - 29) \cdot 0.65 \cdot 2 = 59 \text{ mm}$$

k_3 as set out in SS-EN 1995-1-2.

Non-load-bearing layer for fire on side under tension, according to table 7.5, page 139:

$$d_0 = \frac{h_{\text{CLT}}}{6} + 2.5 = \frac{133}{6} + 2.5 = 25 \text{ mm}$$

Residual cross-section:

$$h_{\text{ef}} = h_{\text{CLT}} - d_{\text{char}} - d_0 = 133 - 59 - 25 = 49 \text{ mm}$$

The residual cross-section is 49.3 mm for the unprotected floor slab.

7.4.2 Protected floor structure

Design method for a CLT slab used for a floor structure. The CLT slab is protected by a 12.5 mm gypsum plasterboard panel of type F. The failure time for the plasterboard according to the plasterboard manufacturer is $t_f = 45$ minutes. The floor slab comprises 7-layer CLT made from boards 19 mm thick, and is exposed to fire from the underside. Determine the effective slab thickness after 60 minutes

No char ablation (The adhesive used for bonding between laminations is fully effective in fire)

$$t_{\text{ch}} = 2,8h_p - 14 = 2,8 \cdot 12,5 - 14 = 21 \text{ minutes}$$

Skyddsfaktorerna för en gipsskiva av typ F kan enligt SS-EN 1995-1-2 skrivas som:

$$k_2 = 1 - 0,018h_p = 1 - 0,018 \cdot 12,5 = 0,775$$

$$k_3 = 2$$

The time limit t_a can be calculated in line with SS-EN 1995-1-2 as:

$$t_a = \frac{25 - (t_f - t_{\text{ch}}) k_2 \beta_0}{k_3 \beta_0} + t_f = \frac{25 - (45 - 21) \cdot 0,775 \cdot 0,65}{2 \cdot 0,65} + 45 = 55 \text{ minutes}$$

Charring depth after 60 minutes:

$$d_{\text{char}} = 25 + (t_{\text{req}} - t_a) \beta_0 = 25 + (60 - 55) \cdot 0,65 = 28 \text{ mm}$$

Non-load-bearing layer for fire on side under tension, according to table 7.5, page 139:

$$d_0 = \frac{h_{\text{CLT}}}{6} + 2.5 = \frac{133}{6} + 2.5 = 25 \text{ mm}$$

Residual cross-section:

$$h_{\text{ef}} = h_{\text{CLT}} - d_{\text{char}} - d_0 = 133 - 28,3 - 24,7 = 80 \text{ mm}$$

By protecting the floor slab on the underside with a 12.5 mm gypsum plasterboard panel of type F, the residual cross-section instead becomes 80 mm.

7.4.3 Unprotected wall panel

Design method for a CLT panel used for a load-bearing wall. A wall panel comprising 5-layer CLT made from boards 19 mm thick, exposed to fire from one side. The calculation assumes that no delamination occurs. Determine the effective panel thickness after 30 minutes:

$$d_{\text{char}} = \beta_0 t_{\text{req}} = 0.65 \cdot 30 = 20 \text{ mm}$$

Non-load-bearing layer for fire on side under compression, according to table 7.4, page 139:

$$d_0 = \frac{h_{\text{CLT}}}{15} + 10.5 = \frac{95}{15} + 10.5 = 17 \text{ mm}$$

Residual cross-section:

$$h_{\text{ef}} = h_{\text{CLT}} - d_{\text{char}} - d_0 = 95 - 20 - 17 = 58 \text{ mm}$$

The effect of the fire reaches in as far as the first transverse layer (layer 2). This means that around 57 mm of the wall panel remains and that the remaining load-bearing capacity is provided by two vertical layers.

7.4.4 Protected wall panel

Design method for a CLT panel used for a load-bearing wall. A wall panel comprising 5-layer CLT made from boards 19 mm thick, exposed to fire from one side for 60 minutes. The CLT panel's inner side is protected from fire by a 15 mm gypsum plasterboard panel of type F. The failure time for the plasterboard according to the plasterboard manufacturer is $t_f = 45$ minutes.



CLT panels ready for supplementary layers.

Table 7.6 Characteristic load-bearing capacity of CLT wall panels exposed to fire on one side.

CLT panel and supplementary layers	Load-bearing capacity after 30 min (kN/m)	Load-bearing capacity after 60 min (kN/m)	Load-bearing capacity after 90 min (kN/m)
5 × 19 mm in cold state; 277 kN/m	–	–	–
5 × 19 mm + GtA 13	159	6,5	–
5 × 19 mm + GtF 15	159	82	0.6
5 × 19 mm + GtF 15 + GtA 13	159	159	154
5 × 19 mm + GtF 15 + 15 GtF 15	159	159	159
5 × 19 mm + GtA 13 + mineral wool 45	159	159	6,1

Background: CLT panel 5 × 19 mm, height 2.8 m, centric load, no side loads, timber in all layers has minimum strength class of C24. Load-bearing capacity in cold state 277 kN/m. Failure time for gypsum plasterboard (Gt): GtA $t_f = 21$ minutes, GtF $t_f = 45$ minutes, GtF + GtA $t_f = 80$ minutes.



Inre Hamnen, Sundsvall, Sweden.

Residual cross-section:

$$t_{\text{ch}} = 2.8h_p - 14 = 2.8 \cdot 15 - 14 = 28 \text{ minutes}$$

According to SS-EN 1995-1-2, the protection factors for a gypsum plasterboard panel of type F can be expressed as:

$$k_2 = 1 - 0.018h_p = 1 - 0.018 \cdot 15 = 0.73$$

$$k_3 = 2$$

The time limit t_a can be calculated in line with SS-EN 1995-1-2 as:

$$t_a = \frac{25 - (t_f - t_{\text{ch}})k_2\beta_0}{k_3\beta_0} + t_f = \frac{25 - (45 - 28) \cdot 0.73 \cdot 0.65}{2 \cdot 0.65} + 45 = 58 \text{ minutes}$$

Charring depth after 60 minutes:

$$d_{\text{char}} = 25 + (t_{\text{req}} - t_a)\beta_0 = 25 + (60 - 58) \cdot 0.65 = 26 \text{ mm}$$

Non-load-bearing layer for fire on side under compression, according to table 7.4, page 139:

$$d_0 = 20 \text{ mm}$$

Residual cross-section:

$$h_{\text{ef}} = h_{\text{CLT}} - d_{\text{char}} - d_0 = 95 - 26 - 20 = 49 \text{ mm}$$

This means that two vertical layers remain, with one layer fully intact and around 11 mm of the other vertical layer remaining after 60 minutes of fire. Both layers are load-bearing.

CLT and sound

Sound and sound insulation should be considered at an early stage of the design process, but implementation in the manufacturing phases or on the construction site is naturally also important in achieving a good sound environment. The development of methods, solutions and not least measurements in finished CLT buildings shows that a good sound environment can be achieved.

Since the circumstances vary from object to object, it is vital to consider at as early a stage as possible what requirements and expectations apply for the building and what acoustic needs must be met, and then to select a suitable sound insulation class. It is important that these design adaptations are made in collaboration with acoustic engineers.

8.1 Planning for acoustics

Sound can manifest itself in many different forms. In this context, sound means pressure variations that occur in the air and that are perceptible by the human ear. The strength of a sound in air is a form of pressure, which is why it is denoted in N/m^2 or in Pascals. To make things easier, a logarithmic decibel scale has been developed that is directly related to the pressure. When a sound's strength is stated in decibels (dB), the corresponding value is called the sound pressure level. The sound pressure level is defined such that 0 dB roughly equates to the weakest sound the human ear can pick up. In addition, a change of 1 dB is around the lowest change that can be heard under favourable conditions, while a change of 8 – 10 dB is usually said to correspond to a doubling or halving of the subjective perception of the sound.

Circumstances vary from project to project, so it is essential to establish early on what activities will take place in the building and what acoustic requirements and needs exist, before selecting a suitable sound insulation class. The cost of rectifying acoustic problems due to faulty planning, errors in implementation and other erroneous assessments rises sharply as you move towards the use phase. The planning and design of building acoustics usually involves five acoustic areas: impact sound insulation, airborne sound insulation, room acoustics, sound from traffic and other external sources and sound from installations. This chapter focuses on impact sound and airborne sound.

- 8.1 Planning for acoustics 145
 - 8.1.1 Sound requirements in building regulations 147
- 8.2 Acoustics in CLT structures 151
- 8.3 Floor structures 151
 - 8.3.1 Flat plate floor structure with and without sub ceiling 152
- 8.4 Walls 154
- 8.5 Points to bear in mind 156

Costs of noise countermeasures

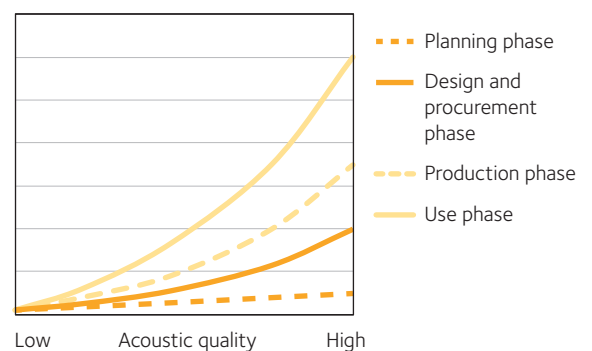

Figure 8.1 Costs of noise countermeasures in different phases.

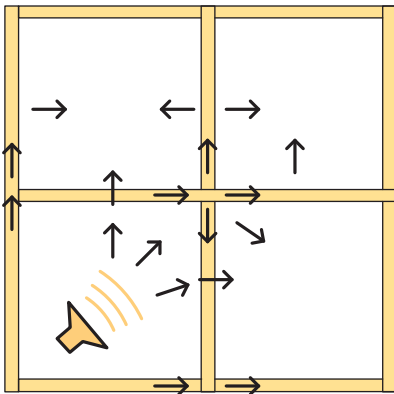

Figure 8.2 Examples of different transmission routes for airborne sound.

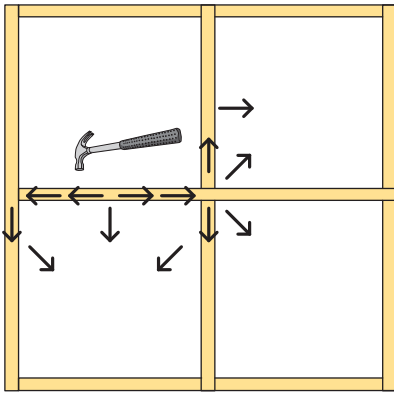

Figure 8.3 Examples of different transmission routes for impact sound.

Airborne sound insulation, *see figure 8.2*, is a measure of how much sound travels from one space to another. The higher the sound insulation value, D , the better the sound quality. The impact sound level, *see figure 8.3*, is a measure of how much sound can be heard in a room when a standardised hammer device strikes the floor in another room. The higher the impact sound value, L , the better the sound quality.

The human ear identifies different frequencies of sound as being a different strength. To account for this, a modified, or weighted, sound pressure level was introduced, and this is now often simply referred to as the sound level. The A-weighted sound pressure level is commonly used, with the designation L_A and decibels (dB) as the unit.

Requirements for peak noise levels are usually expressed with the A-weighting. *Table 8.1* gives a summary of various designations and symbols, along with definitions that are used in the field of building acoustics.

Table 8.1 Summary of designations with accompanying definitions in the field of building acoustics.

Term	Definition
Airborne sound insulation	Insulation against airborne sound such as speech. As high a value as possible is desirable.
D_{nT}	Sound level difference, a measure of a building's ability to insulate a room against airborne sound from another room or from outside. Standardised to a reverberation time of 0.5 s.
$D_{nT,w,50}$	Weighted standardised sound level difference with spectrum adaptation term [dB], an abbreviated way of expressing $D_{nT,w} + C_{50-3150}$.
$D_{nT,w,100}$	Weighted standardised sound level difference [dB], an abbreviated way of expressing $D_{nT,w} + C$.
$D_{nT,A,tr}$	Weighted standardised sound level difference with spectrum adaptation term for sound from mixed road traffic and suchlike [dB], an abbreviated way of expressing $D_{ls,2m,nT,w} + C_{tr}$.
R'_w	Weighted sound reduction in buildings.
Impact sound	Structure-related sound that arises from vibrations such as footsteps. As low a value as possible is desirable.
L_{nT}	Impact sound level, a measure of a building's ability to insulate a room against structure-borne sound from another room or from outside. Standardised to a reverberation time of 0.5 s.
$L_{nT,w,50}$	Weighted standardised impact sound level [dB], an abbreviated way of expressing $L_{nT,w} + C_{1,50-2500}$. If the adaptation term $C_{1,50-2500}$ is negative, it should be set at zero.
$L_{pAeq,nT}$	Equivalent A-weighted sound level [dB], during the time that the sound occurs more than temporarily. Standardised to a reverberation time of 0.5 s.
$L_{pAFmax,nT}$	Maximum A-weighted sound level F (FAST) [dB], for intermittent and more than temporarily occurring short sounds. Standardised to a reverberation time of 0.5 s.
T	Reverberation time, the time it takes for the sound pressure level to fall by 60 dB after the sound has been turned off. Relates to T_{20} .
Direct transmission	Sound that passes directly through the separating structure.
Flanking transmission	Sound that transfers via another part of the structure.

To understand what the designations mean in real life, tables have been drawn up that state the subjective perception of different impact sound levels, for example, *see table 8.2, page 147*.



Table 8.2 Subjective perception of different impact sound levels for lightweight structures with good impact sound damping at low frequencies ($C_{i,50-2500 \text{ max}}$ 4 dB).

$L'_{n,w}$ $L'_{nT,w}$	Slow walking in soft shoes	Slow walking in heeled shoes	Fast walking/running in soft shoes	Fast walking/running in heeled shoes	Children's play/jumping "normal"	Children's play/jumping "advanced"	Gymnastics, heavy thuds, etc.
64		■	■	■	■	■	■
60			■	■	■	■	■
56			■	■	■	■	■
52			■	■	■	■	■
48			–	■	■	■	■
44			–	–	■	■	■
40			–	–	–	■	■

- Heard.
- Can be heard, but not disturbing in normal circumstances.
- Not heard but can be felt.

Source: Boverket's handbook *Bullerskydd i bostäder och lokaler*

8.1.1 Sound requirements in building regulations

The Swedish Boverket's Building Regulations (BBR) set a general requirement that a building's sound environment must be designed so that residents and users are effectively protected against noise.

Table 8.3 Lowest sound level difference and highest impact sound level in homes where special sound insulation measures do not need to be taken, corresponding to sound insulation class C. For other situations and full information, see the current standards from Boverket.

Type of space	Sound level difference $D_{nT,w,50}$ between the spaces (dB)	Impact sound level $L_{nT,w,50}$ in the space (dB)
From space outside home to space inside home.	52	56 ¹⁾
From stairwell and corridor into home.	52	62
From businesses and services and shared garages into home.	56	52
From access balcony, stairwell or corridor with door or window to spaces for sleep, rest or daily social interaction ²⁾ .	44 / 40 ³⁾ / 38 ⁴⁾	62

¹⁾ From bathrooms and storerooms to homes, measured on floor area immediately inside front door (approx. 1 m²).

²⁾ For airborne sound, relates to $D_{nT,w,100}$.

³⁾ Relates to a shared corridor, separated from other spaces, that leads to spaces for sleep and rest, for example in student accommodation and sheltered housing for the elderly.

⁴⁾ Relates to spaces outside homes where significant footfall and high sound levels can be assumed to occur on a more than temporary basis, e.g. from postboxes or lifts.

Table 8.4 Designing a building's sound insulation to combat external sound sources. For other situations and full information, see the current standards from Boverket.

Type of space	Equivalent sound level from traffic or other external sound source, $L_{pAeq,nT}$ (dB) ²⁾	Maximum sound level at night, $L_{pAFmax,nT}$ (dB) ³⁾
Sound insulation is determined based on set sound levels outdoors so that the following sound levels indoors are not exceeded ¹⁾ .		
Spaces for sleep, rest or daily social interaction.	30	45
Spaces for cooking or personal hygiene.	35	–

¹⁾ The type of design may be simplified or detailed in line with SS-EN 12354-3.

²⁾ Relates to design 24-hour equivalent sound level.

³⁾ Relates to design maximum sound level that can be assumed to occur on a more than temporary basis on an average night.

In its general recommendations, BBR states several minimum threshold levels for housing and non-residential buildings. The recommendations also state that if better acoustic conditions are required, sound insulation class A or B can be selected in line with SS 25267 for housing and SS 25268 for non-residential buildings.

The lowest approved values regarding airborne and impact sound can sometimes be set too low. The standards SS 25267 and SS 25268 list several quality levels from sound insulation classes A to D. The developer decides on which sound insulation classes to use in the planning phase and later, in consultation primarily with acoustics experts. A requirement that is set too high can, in many cases, incur an unrealistic cost. Today it is common for housing developers to aim for sound insulation class B.

Table 8.5 Sound insulation classes.

Sound class	Quality
A	Used where an extremely high-quality sound environment is a priority.
B	Suitable for spaces and activities where a better sound environment is a priority.
C	Represents the minimum requirements in Boverket's Building Regulations (BBR). According to a questionnaire, around 20 percent of residents may to some extent feel disturbed by sound in their home when the general recommendations in BBR are met.
D	Low sound standard, used only where the use of sound insulation class C causes unreasonable consequences. A decision on use of sound insulation class D usually requires approval from the local authorities.

Since circumstances vary from object to object, it is essential to identify early on what acoustic needs exist, before selecting a suitable sound insulation class. The sound insulation class clearly shows what values must be met in the various sound categories. For each sound insulation class there is a lowest approved value for airborne sound level and impact sound level, *see tables 8.6 and 8.7, page 149*.

Sometimes there may be a good reason to deviate from the values in the tables.

Table 8.6 Lowest weighted standardised airborne sound level difference, $D_{nT,w,50}$ in dB in line with Boverket's Building Regulations (BBR)

Type of space	Sound class (dB)			
	A	B	C	D
From space outside home to space inside home.	60	56	52	48 ¹⁾
From stairwell and corridor into home.	52 ⁴⁾	48 ⁴⁾	52	40
From businesses and services and shared garages into home.	60	60	56	52
From access balcony, stairwell or corridor with door or window to spaces for sleep, rest or daily social interaction.	52	48	44/40 ²⁾ /38 ³⁾	–

¹⁾ For airborne sound, relates to $D_{nT,w,100}$.

²⁾ Relates to a shared corridor, separated from other spaces, that leads to spaces for sleep and rest, for example in student accommodation and sheltered housing for the elderly.

³⁾ Relates to spaces outside homes where significant footfall and high sound levels can be assumed to occur on a more than temporary basis, e.g. from postboxes or lifts.

⁴⁾ From spaces outside the home, where the sound level can be expected to be low, for example separate floor with entrance door to max four apartments and max 0.5 s reverberation time, it is acceptable to have $D_{nT,w,100} = 44$ dB.

Table 8.7 Highest weighted standardised impact sound level, $L_{nt,w,50}$ in dB in line with Boverket's Building Regulations (BBR).

Type of space	Sound class (dB)			
	A	B	C	D
From space outside home to space inside home.	48	52	56 ¹⁾	60 ²⁾
From stairwell and corridor into home.	48	52	62	62 ²⁾
From businesses and services and shared garages into home.	44	48	52	56
From access balcony, stairwell or corridor with door or window to spaces for sleep, rest or daily social interaction ¹⁾ .	58	62	62	66 ²⁾

¹⁾ From bathrooms and storerooms to homes, measured on floor area immediately inside front door (approx. 1 m²).

²⁾ Requirement relates to $L'_{nt,w}$.

The equivalent values for school and office buildings are set out in tables 8.8 – 8.11. Recommended values for school and office buildings are set out in various standards, with the final choice of levels determined by the activity in question and the neighbouring activities. Other key factors to consider for school and office buildings are values such as reverberation time, equivalent sound level from installations and design sound level from traffic and other external sound sources.

Table 8.8 Lowest weighted sound reduction index in building, R'_{w} , for educational premises: schools, preschools and leisure-time centres.

Type of space	From other space Sound class (dB)				From corridor Sound class (dB)			
	A	B	C	D	A	B	C	D
To spaces for full classroom teaching.	48	44	44	40	44	40	40	30
To spaces for teaching or student work in small groups.	44 ¹⁾	44 ¹⁾	44 ¹⁾	40 ¹⁾	40 ¹⁾	40 ¹⁾	40 ¹⁾	30 ¹⁾
To spaces for teaching or student work in small groups.	40	35	35	30	–	–	–	–

¹⁾ For separating structure with door from other teaching space, values 5 dB lower are acceptable.

Table 8.9 Highest weighted standardised impact sound level, $L'_{nt,w}$ for educational premises: schools, preschools and leisure-time centres

Type of space	From other space Sound class (dB)				From corridor Sound class (dB)			
	A	B	C	D	A	B	C	D
Spaces for assembly of more than 50 people ¹⁾ .	48	48	52	–	40	44	48	56
Spaces for full classroom teaching ¹⁾ .	56	56	60	–	52	52	56	60
Other teaching spaces.	60	60	64	–	56	56	60	64

¹⁾ For sound insulation classes A and B, $L'_{nt,w} + C_{1,50-2500}$ must also meet the set threshold values.

Table 8.10 Lowest weighted sound reduction index in building, R'_{w} , for offices.

Type of space	From other space Sound class (dB)				From corridor Sound class (dB)			
	A	B	C	D	A	B	C	D
To spaces for individual work or conversations.	40	35	35	–	35	30	30	–
To spaces that require moderate confidentiality or privacy.	48	44	44	40	40 ¹⁾	35 ¹⁾	35 ¹⁾	30
To spaces that require high confidentiality.	52	52	48	48	44	44	40	40
To spaces used by other tenants.	52	52	48	44	52	52	48	44

¹⁾ For separating structures with large glazed sections that provide a clear view of what is happening outside, values 5 dB lower are acceptable.

Table 8.11 Highest weighted standardised impact sound level, $L_{nT,w}$, in dB for offices.

Type of space	From spaces with low impact sound load Sound class (dB)				From spaces with high impact sound load Sound class (dB)			
	A	B	C	D	A	B	C	D
To spaces for presentations to more than 20 or so people.	52	60	60	–	48	56	56	64
To spaces for individual work or conversations.	68	–	–	–	64	64	68	–
To spaces with a demand to remain undisturbed.	64	–	–	–	60	60	64	–
From and to someone else's activity.	64 ¹⁾	64 ¹⁾	68 ¹⁾	–	60 ¹⁾	60 ¹⁾	68 ¹⁾	–

¹⁾ The requirement relates to normalised impact sound level, $L'_{n,w}$.



Example of a vibration-damping intermediate layer.

At the final inspection, it is common to hand over documents verifying compliance with the acoustic requirements. The verification may take the form of measurements or of checks in the design and implementation phases, or a combination of the two. The inspection plan sets out which verification method is to be used. Finally, the scope of the verification is decided in an agreement between the developer and the contractor.

Airborne sound insulation can, to some extent, be checked via visual inspection. Airborne sound insulation tests may need to be performed on party walls between apartments, following standardised procedures. Impact sound insulation can also be checked via visual inspection in the form of checks that the chosen flooring matches the technical specifications. In cases of uncertainty, random checks should be carried out, with the inspection plan stating which structures were involved.

8.2 Acoustics in CLT structures

As with other lightweight structures, low-frequency sound is difficult to insulate against in CLT structures. It is therefore important to design a high-performance floor structure, since it is difficult to rectify any problems retrospectively. Floor structures can handle normal spans using the CLT slab thicknesses that are available on the market. In the case of long spans and where there is a need to stiffen up the slab, load-bearing, lightweight interior walls can be used for the loads that occur in the serviceability limit state, plus sagging and vibrations. In this case, direct sound transmission between the apartments must also be taken into consideration.

In most cases, flanking transmission must be minimised in order to achieve a good sound environment, *see figure 8.2, page 146*. There are, in principle, two methods for this: vibration damping using flanking transmission barriers or separate inner cladding of load-bearing elements. A combination of these methods can also be used.

Flanking transmission barriers are used to reduce the vibrations primarily in a vertical direction. They tend to involve elastic isolation strips that are fitted to create a separation between the floors and so reduce the transfer of sound, while still permitting the transfer of static forces. Flanking transmission barriers may take various forms. Good results have been achieved not only with elastic barriers, but also non-elastic barriers in the form of steel bearings. An elastic joint must be able to absorb any forces of lift. The fixings needed for this must, however, not compromise the joint's acoustic function.

8.3 Floor structures

A floor structure must meet several demands at the same time, including sound insulation, but also load-bearing capacity, fire resistance and so on. Double structures are usually required to achieve a high level of sound insulation and meet all the other needs as well. It is better for the acoustics if the floor structure is constructed in two sections that are acoustically entirely separate from each other and from load-bearing walls.

The sound created by footsteps or walking is spread via the upper part of the floor structure and transferred to load-bearing walls in the form of vibrations. These vibrations radiate out as undesirable sound into neighbouring rooms and are known as flanking transmission. Impact sound also generates high energy at low frequencies, particularly in lightweight structures. Normally a structure with good impact sound insulation will normally also meet the requirements for airborne sound.



Example of a steel bearing that reduces flanking transmission.

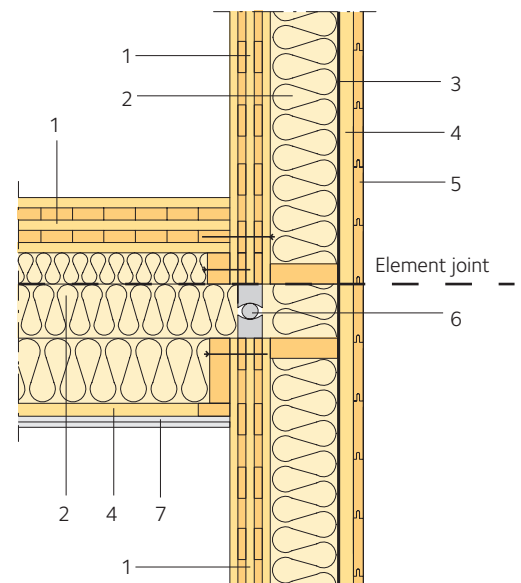

Figure 8.4 Example of connection floor to external wall.

1. CLT panel
2. Insulation
3. Wind protection
4. Batten
5. Exterior cladding
6. Steel bearing to reduce flanking transmission
7. Gypsum plasterboard



A test house designed for sound measurements, comprising 3 – 4 units.

8.3.1 Flat plate floor structure with and without sub ceiling

Sound requirements concerning structural components and between structural components must be met in all directions, both horizontally and vertically. Usually the vertical direction is the design factor. Determining acoustic properties and assessing the sound insulation capacity of different structures is complex and the stated values are often based on empirical tests and measurements in completed structures. Numerous experiments and tests have been conducted over the past decade and manufacturers now have experience from several completed buildings.

For example, experiments were performed in a test house to compare the importance of different supplementary material layers under conditions that are as realistic as possible. The test house comprised two rooms on two storeys (length 3.8 m, width 3.4 m, internal height 2.5 m) with floor and wall structures as set out in table 8.12.

Sound measurements were taken for many different designs. The standard design borders on today’s approved values. Airborne sound insulation can be improved by adding additional layers of gypsum plasterboard to the freestanding stud wall. Establishing asymmetry in the partition wall creates better conditions for improving horizontal airborne sound insulation. Horizontally, sound insulation class A can be achieved regarding impact sound levels. Vertically, impact sound levels corresponding to sound insulation class C are achieved.

There are naturally a wide variety of options for designing floor structures with CLT slabs as the load-bearing element. Below are several different floor structure solutions for which sound measurements have been conducted down to 20 Hz. The measurement values depend on several factors, such as design, room size and so on, so the stated values are to be taken as a guide only. See also table 5.4, page 102.

Table 8.12 Structures in the test house.

Building component	Structure in basic format
Floor structure	170 mm CLT slab, suspended + 24 × 40 mm ² elastomer + 195 mm self-supporting framework with insulation + 2 × 13 mm plasterboard
Outer wall	120 mm CLT panel + 70 mm studs, separate 70 mm insulation + 12 mm plywood panel + 13 mm plasterboard
Inner wall	13 mm plasterboard + 12 mm plywood + 70 mm insulation 70 mm studs, separate + 100 mm CLT panel + 70 mm studs, separate 70 mm insulation + 12 mm plywood + 13 mm plasterboard

Table 8.13 Results of sound measurements.

	Impact sound level $L_{nT,w,50}$	Airborne sound insulation $D_{nT,w,50}$	
Design as in table 8.12	56 dB (class C)	52 dB (class C)	Vertical
	48 dB (class A)	51 dB (-)	Horizontal
Extra gypsum plasterboard, walls	57 dB (-)	54 dB (class C)	Vertical
	43 dB (class A)	56 dB (class B)	Horizontal
Extra structure inner wall, 45 mm, asymmetrical or extra gypsum plasterboard on all walls	56 dB (class C)	52 dB (class C)	Vertical
	42 – 48 dB (class A)	53 – 56 dB (class C/B)	Horizontal

Table 8.14 Selection of floor structure designs.

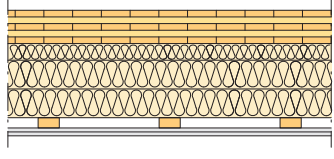
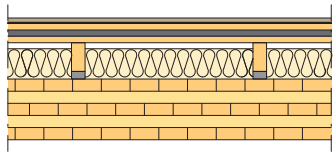
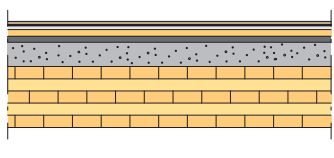
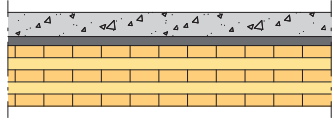
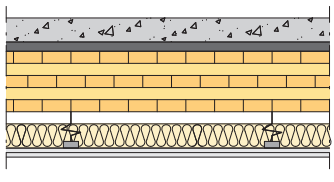
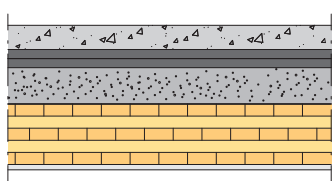
Floor structure type	Material (mm)	Total height (mm)	Weight (kg)	Impact sound $L_{n,w}(C_{1,50-2500})$ (dB)	Airborne sound $D_w(C_{50-3150})$ (dB)
	Floor type 1 140 CLT slab 70 insulation 45 × 220 studs, self-supporting 2 × 95 insulation 28 battens 2 × 13 gypsum plasterboard	449	130	≤ 54	≥ 56
	Floor type 2 14 wood flooring 3 foam underlay 22 fibreboard 20 acoustic matting 22 fibreboard 95 floor joists 95 insulation 25 Sylodyn 220 CLT slab	421	155	≤ 54 (+6)	≥ 52 (-4)
	Floor type 3 14 wood flooring 3 foam underlay 13 plasterboard 22 fibreboard 20 acoustic matting 80 washed gravel 220 CLT slab	372	245	≤ 44 (+6)	≥ 63 (-1)
	Floor type 4 80 concrete 30 acoustic matting dynamic stiffness ≤: 9 MN/m ³ 200 CLT slab	310	270	52 (+5)	63 (-8)
	Floor type 5 80 concrete 30 acoustic matting dynamic stiffness ≤: 9 MN/m ³ 200 CLT slab 120 suspended ceiling joists 80 insulation 2 × 15 gypsum plasterboard	460	310	33 (+17)	79 (-14)
	Floor type 6 80 concrete 2 × 20 acoustic matting, dynamic stiffness ≤: 12 MN/m ³ 120 washed gravel 200 CLT slab 13 plasterboard	453	460	40 (+4)	75 (-7)

8.4 Walls

Where structures are not subject to sound insulation requirements, a CLT panel can be used without any extra additions. The construction of the CLT means that acceptable values are achieved even with 3-layer panels.

Like stud walls, walls made from CLT panels are lightweight walls, compared with heavy structural materials such as concrete and brick. Since mass influences sound insulation, the number of supplementary layers has crucial relevance from an acoustic perspective, but good sound insulation can also be achieved by utilising double structures.

A simple CLT wall can be expected to provide airborne sound insulation as shown in *figure 8.5*.

A good double structure comprises double sheets of CLT separated by a cavity partially filled with insulation. The level of sound insulation provided depends on the mass and stiffness of the CLT panels, the distance between the panels and the type of insulation used. The distance between the CLT panels should be at least 100 mm, although a greater distance between the panels ensures better sound insulation properties. To avoid resonance between the CLT panels, the resonance frequency, f_0 , should be lower than 35 Hz for party walls, to achieve a good sound environment.

When it comes to the composition of external and party walls, many options and preferences come into play. Exposed on the inside, internal layer for installations, lightweight insulation between studs or thick insulation and just long wood screws to fix the façade layer in place – these are just some of the possible combinations. The composition of party walls using CLT can, in principle, be divided into two alternatives: double CLT wall panels and single CLT wall panels that are encased in stud structures. In *table 8.15*, *page 155* several different types of external walls and partition walls are presented. The values stated in *table 8.15* are to be taken as a guide only. See also *table 6.7*, *page 123* and *table 6.8*, *page 124*.

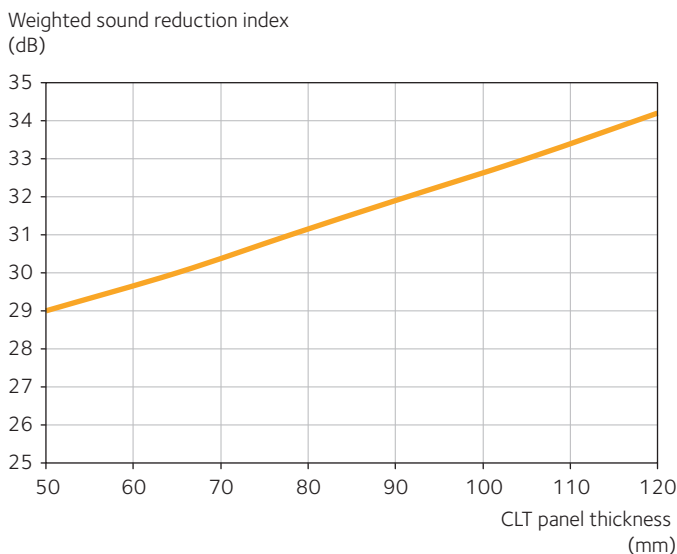

Figure 8.5 Weighted sound reduction index ($D_w + C_{50-3150}$) for CLT panels. The curve is based on laboratory measurements of walls 65 mm and 105 mm thick. The weighted sound reduction index excluding adaptation term will be 1 dB higher.

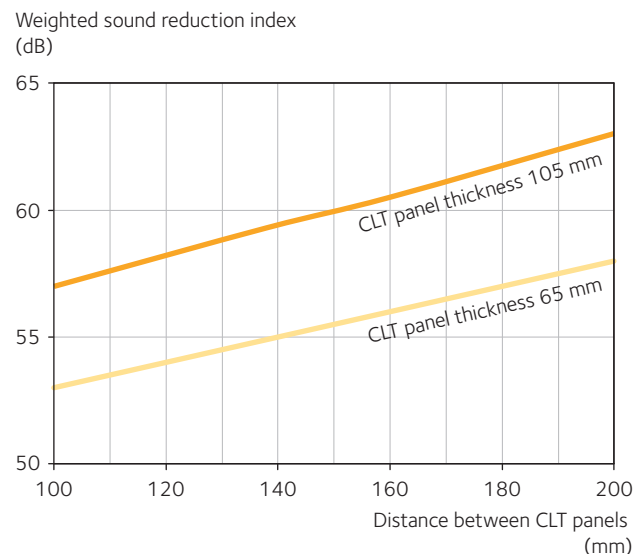
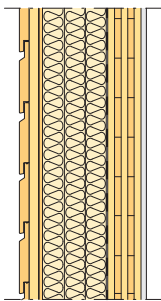
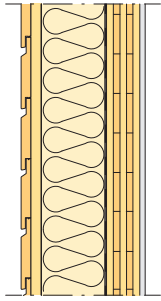
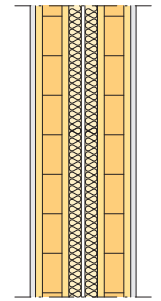
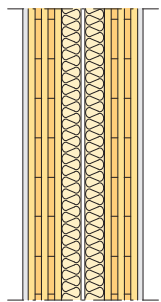
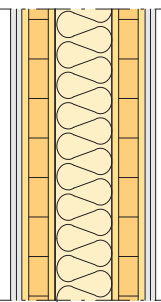

Figure 8.6 Weighted sound reduction index ($D_w + C_{50-3150}$) for CLT panels. The curve is based on laboratory measurements of walls 65 mm and 105 mm thick. The weighted sound reduction index excluding adaptation term will be 1 dB higher.

Table 8.15 Selection of wall designs.

Wall type	Material (mm)	Total thickness (mm)	Airborne sound $D'_{w'} (C, C_{tr})$ (dB)	Fire safety class/ U-value ($W/m^2 \text{ } ^\circ C$)
	External wall type 1 22 exterior cladding 22 battens Wind barrier 12 x 70 plywood 70 heavy insulation 145 studs 70 + 70 insulation Vapour retarder 120 CLT panel 15 fire-resistant plasterboard	412	$D'_{w'} = 48 - 55$	EI90 / 0.15
	External wall type 2 22 exterior cladding 27 x 97 LVL, c600 200 heavy insulation Vapour retarder 120 CLT panel 15 fire-resistant plasterboard	384	$D'_{w'} = 52$	EI90 / 0.15
	Internal partition wall type 1 15 fire-resistant plasterboard 80 CLT panel 45 - 70 insulation 20 cavity 45 - 70 insulation 80 CLT panel 15 fire-resistant plasterboard	300 - 350	≥ 52 (100 mm between CLT panels) or ≥ 48 (50 mm between CLT panels) ≥ 56 (170 mm between CLT panels) ≥ 58 (200 mm between CLT panels)	EI60 (fire on one side)
	Internal partition wall type 2 13 plasterboard 120 CLT panel 45 insulation 20 cavity 45 insulation 120 CLT panel 13 plasterboard	376	≥ 55 (100 mm between CLT panels) or ≥ 50 (50 mm between CLT panels) ≥ 60 (170 mm between CLT panels) ≥ 61 (200 mm between CLT panels)	EI60 (fire on one side)
	Internal partition wall type 3 2 x 15 fire-resistant plasterboard 70 CLT panel 170 loose fill insulation 70 CLT panel 2 x 15 fire-resistant plasterboard	370	$D'_{w'+C50-3150} \geq 60$	EI60 (fire on one side)

8.5 Points to bear in mind



Multi-storey building, Skellefteå, Sweden.

At an early stage, map out the conditions and discuss layout issues based on SS 25267 and SS 25268, and go through the acoustic wishes and requirements. Convert the wishes and requirements into a sound insulation class and clear design instructions. Rules of thumb for tall buildings include:

In the planning and design phase:

- Use the minimum requirements set out in Boverket's Building Regulations (BBR), sound insulation class C, but work towards sound insulation class B with an extra focus on low frequencies.
- Prioritise impact sound insulation.
- Minimise spans.
- Plan for a slightly thicker floor structure than is traditional.
- Load-bearing floor structures should have vibration damping in the sub ceiling or flooring.
- Design nodes regarding sound and document them clearly.
- Space for installations.
- Calculate and clearly document the placement and density of flanking transmission strips.
- Avoid placing vibrating equipment or heavy installations on light-weight floor structures. If possible, place these on an isolated plinth on the foundation slab.

In the construction phase:

- Inform workers and subcontractors about the importance of precise work in achieving good acoustic standards.
- Check that there are no "short-circuits" between load-bearing elements and vibration-damping elements.
- Conduct control measurements and visual inspections before encasing.
- Always check the floor structure and take sound measurements, in good time before completion.

CLT, heat and moisture

Building engineering physics is the science of heat, air, moisture and sound in buildings. Much of the science focuses on flows and how heat, air, sound and moisture spread and travel through building components and buildings. Using a CLT structural frame presents many benefits in terms of indoor climate and energy. With the right design and attention to the CLT frame's properties, the cost of installations can be kept lower than for many other construction systems. A good indoor climate has a major impact on the people who spend time in the building.

The Nordic climate generally requires a building to be heated to achieve a pleasant climate indoors. When heat is emitted by installations or devices and people, for example in offices, cooling may also be necessary at certain times. Cooling may also be needed in the summer, when the sun and high outdoor temperatures heat up the building. In a room enclosed by walls, a floor and a ceiling that have a high capacity to store heat, like those that use CLT, the temperature will be evened out over the course of the day. As the building component cools down, the air is warmed up and conversely as the building component absorbs heat, the air is cooled down. The condition for getting the benefit of this equilibrium effect and the energy savings it brings is that you must be happy for the indoor temperature to fluctuate by a few degrees up and down. If the temperature is strictly controlled, the heating will start as soon as the temperature falls just a little bit, and similarly the cooling will be triggered when the temperature rises, which leads to greater energy consumption.

9.1 CLT and thermal mass, moisture buffering

It is well known that log cabins with thick, solid wood walls have a pleasant indoor climate. Many measurements and computer simulations have been carried out to establish whether this translates to the indoor climate in buildings with a CLT frame or similar frame and what effect it has on energy efficiency. The results indicate that such buildings are pleasant to live in, while energy consumption for heating is low. It is possible to achieve a significant reduction in energy consumption for heating, compared with stud walls and light-weight floor structures.

The wood's low thermal conductivity also makes the surface of floors and walls pleasant to touch. Since there are few thermal bridges and the wooden surfaces do not feel cold, the indoor temperature can be lowered by up a couple of degrees while still retaining that pleasant feel. The room is also quicker to heat up after getting cool.

9.1 CLT and thermal mass, moisture buffering 157

9.2 CLT and moisture-related movement 160

9.3 CLT and thermal insulation 160

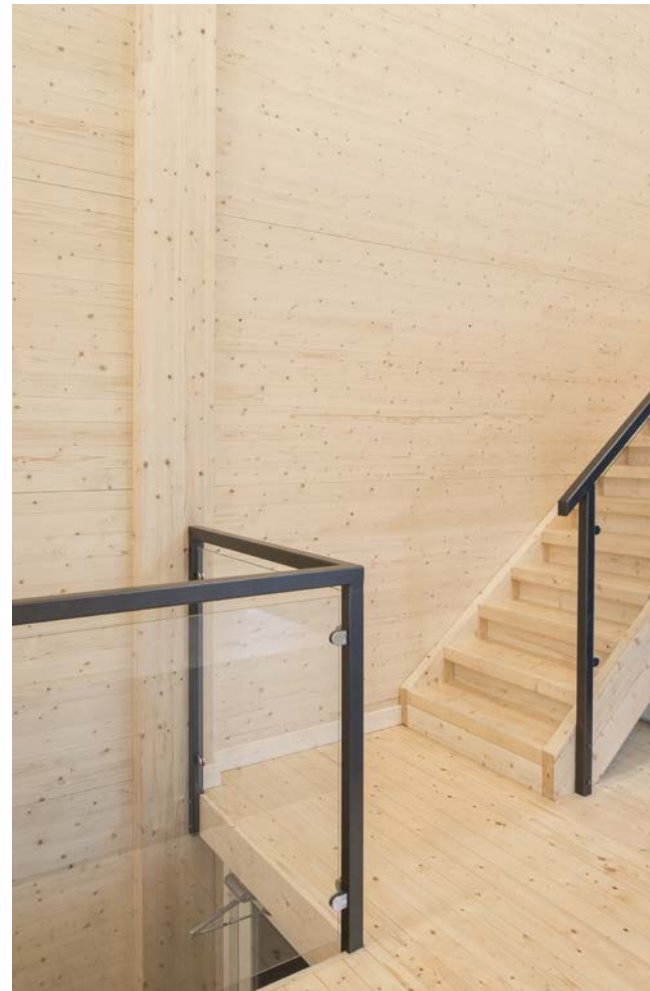

Office building, Ålta, Sweden.

Table 9.1 Material data for some common construction materials.

Material	Thermal conductivity (λ) (W/m °C)	Specific thermal diffusivity (a) (m ² /s)	Heat capacity (c) (J/kg °C)
CLT	0.13	$0.19 \cdot 10^{-6}$	1,600
Lightweight concrete	0.14	$0.28 \cdot 10^{-6}$	500
Mineral wool	0.04	$0.30 \cdot 10^{-6}$	120
Plasterboard	0.25	$0.31 \cdot 10^{-6}$	720
Brick	0.6	$0.44 \cdot 10^{-6}$	1,350
Concrete	1.7	$1.00 \cdot 10^{-6}$	1,000

Table 9.2 Periodic penetration depth for a temperature cycle of 24 hours for various materials.

Material	Periodic penetration depth (mm)
Wood	70
Plasterboard	90
Lightweight concrete	90
Brick	110
Concrete	140
Mineral wool	160
Stone (granite)	210

The thermal mass of building carcasses, i.e. their capacity to store heat, and the benefits of thermal mass are determined by several factors: material, construction method, airtightness, phase shift and so on. The optimum scenario is to store the quantity of heat that you would otherwise have lost in the exchange of air. High standards are also required from other parts of the building envelope. The envelope must be airtight and well insulated to prevent heat from disappearing through the wall. Installations such as ventilation and the regulation of radiators must also be adapted to make best use of the thermal mass.

A material’s capacity to store heat depends on its weight and its specific heat capacity, see table 9.1. In comparison to other materials, wood has a high thermal mass thanks to its high specific heat capacity, c , despite its low density. Specific heat capacity is defined as the amount of heat in Watts (W) or Joules (J) that is required to raise the temperature of one kilo of the material by one degree. Thermal conductivity, λ , is a material property that indicates how readily heat is transported within a material. This translates as the material’s thermal insulation capacity. Another measure that is of interest is thermal diffusivity, a , which indicates how quickly a temperature change spreads in the material.

When it comes to storing heat in sunlit interior walls, for example, penetration depth is also significant, since it expresses how much of the material is active during a set time. The periodic penetration depth for various materials is shown in table 9.2.

A further benefit that can be ascribed to mass timber outer walls, because of their high thermal capacity and low thermal conductivity, is phase shift, η , which occurs between the temperatures of the outside and inside of the wall. Phase shift describes the time within which the highest daytime temperature transfers from the outside to the inside through a building component, bringing the room’s indoor temperature in line with the outdoor temperature. In a mass timber wall, it takes a long time for the peak heat on the outside of the wall to reach inside, as long as 12 hours in fact. To ensure a large phase shift in the outer wall, the temperature conductivity, a , in units of (m kg °C)/J, needs to be low. This should not be confused with a in table 9.1. The temperature conductivity can be expressed using equation 9.1:

$$9.1 \quad a = \frac{t}{c}$$

where:

- t is the wall thickness in metres.
- c is the wall’s heat capacity in J/(kg °C).

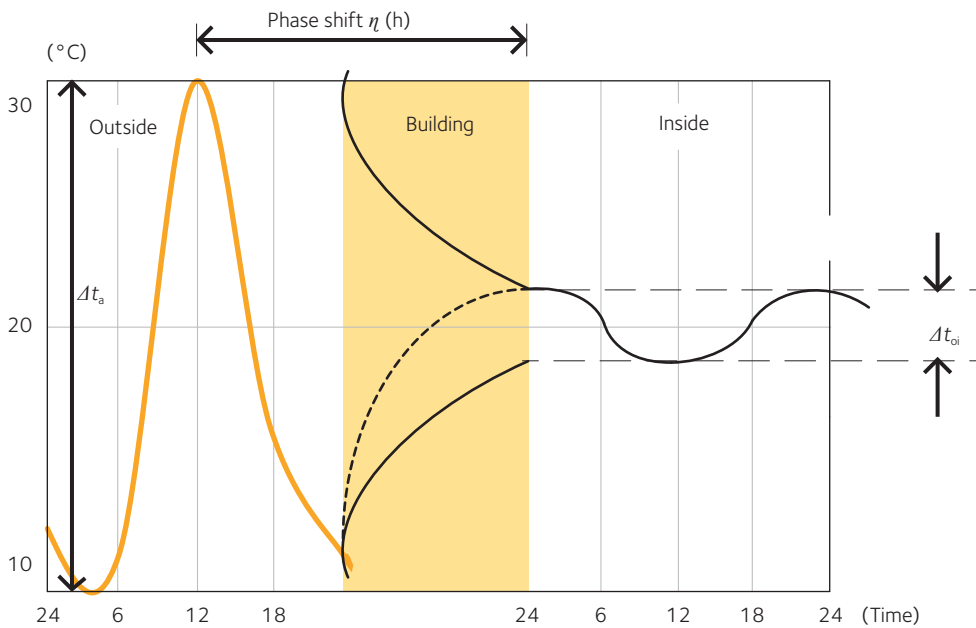

Figure 9.1 Graph of phase shift and amplitude change for a wall structure.
Source: *BSPhandbuch*.

To achieve the same phase shift in a stone wall, it would need to be around twice as thick as a mass timber wall.

When describing the temperature changes in an outer wall, it is interesting to look at the change in amplitude of the temperature in the wall and the phase shift. It is then possible to study the exterior wall's external surface temperature and the exterior wall's internal surface temperature. In principle, this can be described as in *figure 9.1*.

The amplitude attenuation θ can be calculated using *equation 9.2*:

$$\theta = \frac{\Delta t_a}{\Delta t_{oi}} \quad 9.2$$

where:

- Δt_a is the temperature amplitude outdoors in °C.
- Δt_{oi} is the temperature amplitude indoors in °C.
- η is the phase shift in hours.

The values that are often sought are an amplitude attenuation that is greater than 3.3 for external walls and greater than 5.0 for roofs. For example, $\theta = \Delta t_a / \Delta t_{oi} = 25 \text{ °C} / 5 \text{ °C} = 5$. At the same time, the phase shift should be greater than 10 hours to achieve a pleasant indoor climate.

It is possible to influence the phase shift and amplitude attenuation, depending on how the structure is constructed and what constituent materials are chosen, see *table 9.3*.

Table 9.3 Temperaturrens fasförskjutning beroende av väggens uppbyggnad.

Väggtyp (mm)	Thermal transmittance (U) (W/m ² °C)	Effective storage mass (m) (kg/m ²)	Phase shift (η) (h)	Amplitude attenuation (θ)
120 CLT	0.88	31	7.8	3.76
95 mineral wool 120 CLT	0.32	38	10.7	23.8
95 mineral wool 120 CLT 50 mineral wool 15 plasterboard	0.22	48	16.3	60.8



Pavilion with curved CLT, Austria.

Design against condensation

The task of the external walls is to maintain a temperature difference between the indoor air and the outdoor air. The building envelope is subject to major climate variations, which means that moisture conditions will vary, while the increasing thickness of insulation also carries a risk of condensation within the structures. Moisture calculation programs are available to help assess the risk of interior condensation. A structure can be considered to meet the requirements if condensation does not occur or if the condensed water can be led away over time. Alternatively, the amount of condensation may be so small compared with the material's capacity to store the condensed moisture until it can evaporate away that no damage can be expected to occur. A mass timber frame has the capacity to store moisture. The local moisture content in the wood material should, however, remain below 18 % to prevent rot and microbial growth.

To avoid diffusion through a wall or roof structure, some form of vapour barrier is commonly used. CLT panels with at least 5 layers and a thickness of more than 70 mm can in many cases function as a vapour retarder, removing the need for an extra layer to prevent diffusion through the structure. It does, however, require that the joints between floor structure and wall, or wall and wall, for example, can be designed in a way that achieves the requisite airtightness.

9.2 CLT and moisture-related movement

When the wood's moisture content changes, the wood's volume also changes. The wood either swells or shrinks. This dimensional change differs across the different directions in the wood. It is negligible with the grain, greatest in the tangential direction and somewhat less in the radial direction, *see table 9.4*.

Considering the wood's moisture-related movement, it is important for an encased component to have a moisture content that matches the environment in the finished building as closely as possible.

CLT panels have more or less the same moisture-related movement as plywood panels. Depending on how great a proportion of the fibres are oriented in each direction, the swelling or shrinkage in the CLT panel's plane will amount to around 0,016 – 0,023 % per percentage change in the moisture content, which is negligibly more than for wood parallel to the grain. *See also chapter 1.6.3, page 20.*

Table 9.4 Moisture-related dimensional changes in wood.

Material: Pine and spruce	Percentage dimensional change for a 1 % change in moisture content
Parallel with grain	0.01 – 0.02
In radial direction	0.19
In tangential direction	0.36
Average across the grain	0.24

9.3 CLT and thermal insulation

When CLT panels are used in an external wall, they are usually accompanied by insulation and a façade layer. The façade is there to achieve a stationary climate in other parts of the wall. Under stationary conditions, for example during the long winter periods, the heat flow through the wall is determined only by its thermal transmittance value, known as the U-value. The U-value is the inverse value of the total thermal resistance, R, in a building component. A CLT panel has an insulating effect and has few thermal bridges. CLT is usually placed against the warm side, with the flat surface providing a good substrate for supplementary layers of full-coverage insulation.

Wood has good thermal insulation properties, but additional insulation is required to meet modern standards for the building envelope. A CLT frame makes an excellent pairing with another form of wood-based insulation, since both materials have similar physical properties, but mineral wool insulation is the most common insulation material in Sweden. Ongoing research shows that mass timber frames can have a positive impact on a building's energy consumption.

The U-value or thermal transmittance coefficient states how much heat flows through 1 m² of wall for a temperature difference of 1 °C between the warm and the cold side.

The thermal conductivity of wood depends on the wood's density and moisture content. For dried pine and spruce with a moisture content of around 12 % the thermal conductivity, known as the lambda value, $\lambda = 0.10 - 0.12 \text{ W/m } ^\circ\text{C}$, which is about three times the value for traditional insulation. For practical purposes, the value used tends to be $\lambda = 0.13 - 0.14 \text{ W/m } ^\circ\text{C}$.

To determine a structure's insulating capacity, the following process can be used:

- a) **Determine the thermal conductivity, λ** , for all the constituent materials, *see table 9.5*. Other values can be sourced from product sheets, handbooks or standards
- b) **Determine the thermal resistance, R**, for air gaps and the surface resistance values, R_{si} and R_{se} . Standard SS-EN ISO 6946 differentiates between three different types of air gap, *see table 9.6*

Table 9.5 Thermal conductivity for various materials.

Material	Thermal conductivity, λ (W/m ² °C)
Insulation	0.040
Wood	0.14
Fibreboard	0.14
Plasterboard	0.25
Concrete	1.7

Table 9.6 Thermal resistance for different air gaps.

Air gap	Thermal resistance, R (m ² °C/W)
Unventilated air gaps	< 0.18
Poorly ventilated air gaps	< 0.15
Well ventilated air gaps	0

Table 9.7 Surface resistance for various building components.

Building component	Internal surface resistance, R_{si} (m ² °C/W)	External surface resistance, R_{se} (m ² °C/W)
Walls	0.13	0.04
Ceiling	0.10	0.04
Floor	0.17	0.04

Table 9.8 Examples of correction factors for external walls.

Building component	ΔU (W/m ² °C)
External wall with an insulating layer with studs	0.01
External wall with intersecting studs	0



Insulation of CLT wall.

c) **Determine correction factors, ΔU** , for fixings, gaps and crevices,

where:

ΔU_f is a correction factor for extra heat flow due to small fixings in the structure. This is usually negligible, particularly for wooden structures.

ΔU_g is a correction factor that takes account of normal errors when assembling the structure.

d) **Calculate the thermal transmittance coefficient** for whole structures.

If the structure only contains homogeneous layers, the thermal resistance of each layer is calculated and added together, after which the U-value can be calculated using equations 9.3 – 9.5:

$$9.3 \quad R = \frac{d}{\lambda} \quad [\text{m}^2 \text{ } ^\circ\text{C} / \text{W}]$$

$$9.4 \quad R_T = R_{si} + R_1 + R_2 + \dots + R_n + R_{se} \quad [\text{m}^2 \text{ } ^\circ\text{C} / \text{W}]$$

$$9.5 \quad U = \frac{1}{R_T} + \Delta U_g + \Delta U_f \quad [\text{W} / \text{m}^2 \text{ } ^\circ\text{C}]$$

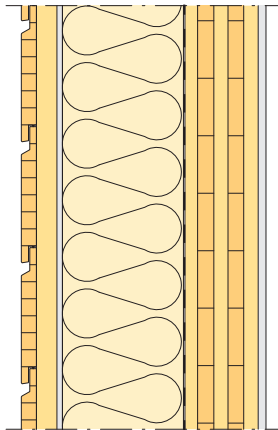

Figure 9.2 Cross-section external wall.

When calculating the U-value for a structure that contains non-homogeneous layers such as studs in an insulation layer, there are two ways to calculate the thermal transmittance coefficient according to SS-EN 6946, the U-value method and the λ -value method. The calculations give a lower and an upper value for the total thermal resistance, R . The thermal resistance used to produce the U-value is then the average value of the two thermal resistance figures obtained previously.

Weighting under the U-value method uses areas perpendicular to the heat flow, while under the λ -value method the weighting produces a new λ -value for each non-homogeneous layer.

Example:

A wall with the following composition: 13 mm plasterboard, 100 mm CLT panel, vapour retarder, 170 mm sheet insulation with 12 % studs, wind barrier, 34 mm air gap, horizontal glulam cladding, see figure 9.2.

Weighting under the U-value method uses areas perpendicular to the heat flow. In this case, we only have two areas in the non-homogeneous layer, wood and insulation.

$$A_1 = 0.12 \quad [\text{m}^2]$$

$$A_2 = 0.88 \quad [\text{m}^2]$$

Four U-values are calculated, and the process begins by totalling up the resistances for the two cases. The thermal resistance figures for the plasterboard and the CLT panel are always included, plus the two surface resistance figures, and they all add up to:

$$R = 0.052 + 0.769 + 0.130 + 0.040 = 0.991 \quad [\text{m}^2 \text{ } ^\circ\text{C} / \text{W}]$$

Case 1: Area A₁, timber studs

$$R_1 = 0.991 + \frac{0.170}{0.14} = 2.205 \quad [\text{m}^2 \text{ } ^\circ\text{C} / \text{W}]$$

$$U_1 = \frac{1}{2.205} = 0.454 \quad [\text{W} / \text{m}^2 \text{ } ^\circ\text{C}]$$

Case 2: Area A₂, sheet insulation:

$$R_2 = 0.991 + \frac{0.17}{0.037} = 5.586 \quad [\text{m}^2 \text{ } ^\circ\text{C} / \text{W}]$$

$$U_2 = \frac{1}{5.586} = 0.179 \quad [\text{W} / \text{m}^2 \text{ } ^\circ\text{C}]$$

The U-values are weighted together using the areas:

$$U_u = 0.12 \cdot 0.454 + 0.88 \cdot 0.179 = 0.212 \quad [\text{W} / \text{m}^2 \text{ } ^\circ\text{C}]$$

which gives:

$$R_u = \frac{1}{0.212} = 4.717 \quad [\text{m}^2 \text{ } ^\circ\text{C} / \text{W}]$$

Under the **λ -value method** a new weighted λ -value is created for each non-homogeneous layer. The proportion of wood in the non-homogeneous layer is 0.12:

$$\lambda = 0.12 \cdot 0.14 + 0.88 \cdot 0.037 = 0.0494 \quad [\text{W} / \text{m} \text{ } ^\circ\text{C}]$$

The R-value is thus:

$$R_\lambda = 0.901 + \frac{0.170}{0.0494} = 4.342 \quad [\text{m}^2 \text{ } ^\circ\text{C} / \text{W}]$$

The average value for the two methods gives:

$$R_T = \frac{(R_u + R_\lambda)}{2} = \frac{(4.608 + 4.342)}{2} = 4.475 \quad [\text{m}^2 \text{ } ^\circ\text{C} / \text{W}]$$

And then the U-value comes out as:

$$U = \frac{1}{R_T} = 0.223 \quad [\text{W} / \text{m}^2 \text{ } ^\circ\text{C}]$$



Multi-storey building, Finland.

Purchasing and assembly

10.1 Enquiry and purchasing 164

10.2 Handling CLT correctly 164

- 10.2.1 Delivery, acceptance and storage 165
- 10.2.2 General principles for lifting and handling CLT panels 169
- 10.2.3 Self-weight of components and dynamic effects 167
- 10.2.4 Example: Designing the fixing of anchor screws for lifting 169
- 10.2.5 Frame stabilisation during construction 169

10.3 Protecting the structure during construction 170

- 10.3.1 Weather protection during construction 170
- 10.3.2 Controls and monitoring 171

10.4 Points to bear in mind 174

10.1 Enquiry and purchasing

The enquiry should contain all the relevant information that the CLT manufacturer needs in order to provide a complete quotation. In addition to the price, questions about the material's strength class and appearance grade, dimensions and weight, delivery times and so on have to be answered. If you want the supplier to be involved in the design work, this should be made clear in the request for a quotation. In many cases, it can be beneficial to send plans and cross-sectional views to the suppliers, in order to receive suggestions about the division and optimisation of deliveries.

A well-built CLT structure depends on a correct and consistent description. To achieve an efficient and fault-free delivery, it is important to submit as detailed an enquiry as possible. Some of the elements that should be included in an enquiry are listed in *table 10.1*.

The CLT components are delivered with the specified dimensional accuracy. It is crucial to take this into account so that the components can be tied in with site-built structures. These should have the same tolerances as the CLT components and if this is not possible, the planning needs to take account of that fact. Suspended floor structures, the type that are hung between the walls, require considerable precision during the setting out. It has to be made crystal clear to the person responsible for the setting out work just what tolerances apply.

10.2 Handling CLT correctly

Like all construction products, CLT panels and components need to be stored and handled carefully, a factor that has a significant impact not only on the durability and design, but also on the project's finances and planning.

An important question on all building projects is how to handle the weather protection during construction, and how to avoid the risk of future damage caused by moisture. The question of how to protect the building work from the elements should be given high priority in the planning work. A major advantage of building in wood is the short construction time. To get maximum benefit from this, the wood should be protected from moisture, so that no drying is required on the construction site. The basic rule of thumb in this context is that structural elements that are sensitive to the weather, such as prefabricated structural components, should be encased for their protection as quickly as possible. If it is not possible to encase these elements immediately, they should be provided with temporary weather protection that is as effective as possible. When scheduling a project, there is some scope to steer the planning towards prioritising the quick encasement of moisture-sensitive structure elements.

Table 10.1 List of information that should be included in an enquiry for CLT.

Text
Component list and clear order of assembly for identification.
No. of units. For different units, specify no. of units and design.
Dimensions and tolerances should be clearly stated.
If exposed surfaces are required, state the appearance grade, <i>see example page 21</i> .
State whether a different wood is required. ¹⁾
Specific preferences concerning packaging, e.g. individual wrapping, loading order, edge protectors for craning, etc.

¹⁾ Availability should be checked before the enquiry is submitted.

The time of year and the local climate in the place where the construction project will take place also have an influence. Planning delivery and assembly in a way that ensures quick and efficient work is also crucial in minimising moisture problems.

10.2.1 Delivery, acceptance and storage

CLT components have relatively low self-weight and their compact form makes them easy to load, transport and unload efficiently. In Sweden, shipments can usually have the following overall dimensions without requiring special transport permits: 24 m long, 2.6 m wide and 4.5 m high. This means that there is usually no problem transporting CLT components in their full format. It is customary for the transport service to be bought from the manufacturer of the CLT panels or prefabricated CLT components. It is important that the components are loaded in the right order, so they can then be unloaded in the order that they will be assembled. Each component should be clearly labelled, so that it can be easily tracked on an assembly plan.

The CLT manufacturer should be given clear details about the order of assembly and should have access to the assembly plan in order to obtain an accurate overall picture of the assembly work.

The following should also be observed:

- Plan the assembly well ahead of unloading to avoid time-consuming rearranging.
- Check that the packaging is intact.
- Check that the number of components and the dimensions match the order and the delivery note.
- Check the delivery and note any visible damage.
- Conduct a random check of the moisture content in a number of places using an electrical resistance moisture meter with insulated hammer electrodes, to get an indication that the moisture content matches the order.
- Check that the CLT components are clear of soil and dirt.
- Avoid temporary storage and, if possible, assemble directly from the truck.
- Do not place CLT components where there is a risk of soiling and splashing from guttering or traffic, for example.
- Make sure the storage location is in the shade in spring, summer and autumn. Sunlight makes the surfaces of packaged CLT hotter than the ambient temperature, which can lead to splitting or condensation, which in turn increases the risk of microbial growth.
- Rest the components on clean supports, at least 300 mm off the ground or the floor, to provide good ventilation. Make sure you have enough supports to stop the CLT components bending.
- The substrate should be dry and level, so the CLT components are not subject to stresses that can cause lasting deformations.

A delivery of CLT normally has a moisture content of no more than 16 % on delivery from the CLT manufacturer. CLT panels or complete structural units are usually transported in protective wrap. If the packaging is fully sealed, the products can be stored outside under a tarpaulin for a short time. If the packaging is broken (even minor tears), it should be repaired or removed completely, and the CLT should continue to be stored in a dry and warm place if it will be used indoors. CLT that will be used in unheated buildings or in an outdoor climate, protected under a roof, can be stored in a cold area, well protected from rainfall. Read more in *section 10.3, page 171* and in *section 10.4, page 174*.



Wall units ready for delivery.



Packages of CLT.



Assembly of CLT floor.

10.2.2 General principles for lifting and handling CLT panels

There are also important health and safety issues to consider when assembling the components. It is, for example, vital that wall units are quickly anchored and braced. Other key issues are the risk of falling and slipping. It is often not practically possible to have safety railings in place during the actual assembly, which is a risk in itself. The alternative is to use safety lines.

A number of different methods are available for lifting and handling CLT panels. The system that should be used is usually up to the CLT manufacturer, but the building contractor should also be consulted. Various types of webbing slings, steel wire ropes and steel chains are commonly used, but the load-bearing capacity should always be checked beforehand.

Floor and wall units are usually lifted with the help of special eyes and lifting yokes. The lifting equipment must be designed so that all the loads are statically determinate. This is to ensure an even distribution of the load across all the lifting points.

Just as there are multiple manufacturers of CLT, there are a number of different suppliers of material for lifting and handling prefabricated components. The suppliers of the CLT components will usually have a standard method that they use, and that can determine the number of lifting points and so on.

Using bolts and load-distributing washers is seen as the safest way to make lifting points in a floor slab. Bolts do, however, must penetrate the surface, and if that surface is intended to be left exposed, the holes will need filling afterwards. The holes also need filling to ensure compliance with sound, waterproofing and fire safety requirements. Another common method is to use spherical head lifting anchors, which are fixed in place with wood screws.

With wall units, simple slings are usually threaded through holes made in the CLT panel. Once the unit is fixed in place, the sling can then easily be removed.

Wall units commonly come with two or four lifting points, depending on the weight and shape of the unit. Wall units with two lifting points should be lifted using a two-leg chain sling with safety hooks. Wall units with four points should be lifted with four safety hooks and wire ropes.

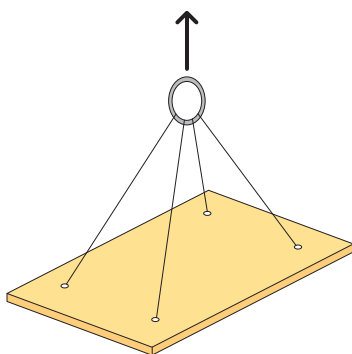

Figure 10.1 Example of a statically determinate system for handling floor and wall units.

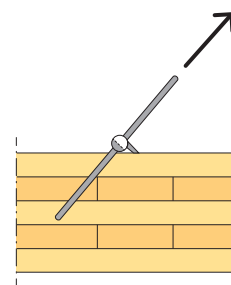
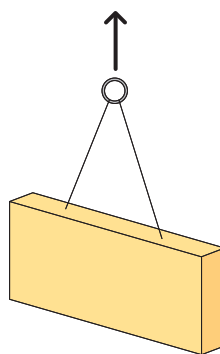

Figure 10.2 Diagram of a spherical head lifting anchor with an angled lifting screw.



Spherical head lifting anchors fixed with wood screws.



Lifting a prefabricated wall unit.

Lifting instructions for wall units

Before work on the wall units begins, the following equipment should be in place on the construction site:

- 4-leg chain sling, including hooks.
- Chain block hoists connected to a webbing strap for adjustment.
- Centre of gravity details from the CLT manufacturer.

Check chains, hooks and chain blocks on a daily basis. If possible, lift the units into place and assemble direct from the truck. Begin wall assembly by hanging two parts of the chain and shortening one part by around 1.5 m. Attach the chain block to this part. The walls are connected individually by chain to one lifting strap and the chain block's hook is connected to the other lifting strap. The wall is adjusted to bring it vertical, in order to distribute the weight and make assembly easier.

10.2.3 Self-weight of components and dynamic effects

The self-weight of floor and wall units depends on the degree of pre-fabrication, the constituent materials and the size. Self-weight is not usually a problem, since even pre-clad CLT panels are relatively light in relation to other similar products. When assembling large units, wind conditions should be taken into account, with wall panels usually considered to be thin and unstable if the lengths exceed 8 – 10 m.

The type and size of the crane depends on the design and weight of the CLT unit. Dynamic effects can occur when lifting such components. This can be accounted for by adding a supplement to the vertical self-weight.

The size of that supplement is determined in part by the crane type and lifting speed, and is set out in standards SS-EN 1990 and SS-EN 1991-3. For commonly occurring construction cranes, the supplement is around 10 – 20 %.

Table 10.2 Guide values for self-weight for certain wall units.

Type	Self-weight, average
CLT general	500 kg/m ³
CLT panel, 70 mm	35 kg/m ²
CLT panel, 180 mm	90 kg/m ²
CLT panel, complete external wall	110–150 kg/m ²



Installation of prefabricated box unit.

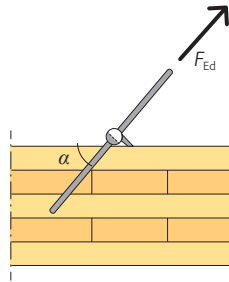

Figure 10.3 Principle for fixing a spherical head lifting anchor.

10.2.4 Example: Designing the fixing of anchor screws for lifting

Calculations are based on Eurocode 5. The ratio between load and load-bearing capacity must meet the requirement represented by equation 10.1:

$$10.1 \quad \frac{F_{Ed}}{F_{ax,Rd}} \leq 1$$

The characteristic withdrawal capacity of a wood screw skewed at an angle α is determined using equation 10.2 and equation 10.3:

$$10.2 \quad F_{ax,k,Rk} = \frac{n_{ef} \cdot f_{ax,k} \cdot d l_{ef} \cdot k_d}{1.2 \cos^2 \alpha + \sin^2 \alpha}$$

$$10.3 \quad f_{ax,k} = 0.52 d^{-0.5} l_{ef}^{-0.1} \rho_k^{0.8}$$

where:

- n_{ef} is the effective no. of wood screws.
- $f_{ax,k}$ is the characteristic withdrawal strength perpendicular to the grain, in N/mm².
- d is the outer thread diameter, in mm.
- l_{ef} is the depth of wood penetration for the threaded part, in mm.
- k_d is the minimum of $d / 8$ or 1.
- α is the angle between the wood screw's axis and the wood grain, with $\alpha \geq 30^\circ$.
- ρ_k is the characteristic density of the CLT, in kg/m³.

The design value for withdrawal capacity is determined using equation 10.4:

$$10.4 \quad F_{ax,Rd} = k_{mod} \frac{F_{ax,k,Rk}}{\gamma_M}$$

where:

- k_{mod} is a modification factor, here for load duration class short term (S).
- γ_M is the partial factor for the material, here 1.3.

Design load F_{Ed} is determined based on the unit's self-weight and any additional dynamic supplement. Design self-weight G_d can be expressed using equation 10.5:

$$10.5 \quad G_d = \gamma_{Sd} (\gamma_{G,j} \cdot G + \gamma_{Q,1} \cdot G \varphi_2)$$

where:

- γ_{Sd} is the partial factor for uncertainty in the calculation model.
- $\gamma_{G,j}$ is the partial factor for permanent action.
- $\gamma_{Q,1}$ is the partial factor for variable action.
- φ_2 is a dynamic factor.

$$10.6 \quad \varphi_2 = \varphi_{2,min} + \beta_2 v_h$$

where:

- $\varphi_{2,min}$ a factor determined by the crane type.
- β_2 is a factor determined by the crane type.
- v_h is the crane's lifting speed.

The vertical component at an incline of 45° is obtained as follows

$$F_{ax,Ed} = \frac{G_d}{n} \quad 10.7$$

where:

n is the no. of lifting points.

The force component in the lifting direction according to *equation 10.8* will thus be:

$$F_{Ed} = \frac{F_{ax,Ed} \sin 90^\circ}{\sin(90 - \beta)} \quad 10.8$$

The ultimate tensile strength of the wood screws should also be checked, for example using *equations 10.9 – 10.11*:

$$\frac{F_{Ed}}{F_{ax,Rd}} \leq 1 \quad 10.9$$

$$F_{ax,Rd} = k_{mod} \frac{F_{t,Rk}}{\gamma_M} \quad 10.10$$

$$F_{t,Rk} = n_{ef} \cdot f_{tens,k} \quad 10.11$$

where:

$f_{tens,k}$ is the characteristic strength of the wood screws under a tensile load, a figure provided by the screw manufacturer.

n_{ef} is the effective no. of wood screws n using $n_{ef} = n^{0.9}$.

10.2.5 Frame stabilisation during construction

If the frame components are lifted into the structure directly on delivery, then that completes the first step in the assembly. Since the assembly of CLT components is a new process for most building contractors, it can be good to have representatives of the CLT manufacturers on site when the assembly begins. This assistance will make the start of the assembly work as effective as possible, since the questions that arise early on can be resolved there and then, without unnecessary delays being caused.

A clear assembly plan should be drawn up in advance. It is common for such a plan to be put together via consultation between the project's structural engineer and the CLT manufacturer. The plan should list the assembly order and weight of the components. The numbering must be easy to compare with the labelling on the component. When assembling wall units, instructions for temporary bracing must be available.

Frame stabilisation is particularly important for buildings taller than two storeys. The walls and floor structures are normally used to stabilise the frame. These are connected together to form a stabilising system using various types of fixings and anchors. The connections have to not only hold the structural components in place but also transfer large horizontal and vertical loads. It is therefore important that the instructions in the construction documents are followed carefully when it comes to which fixings and anchors should be used and how these are used in assembly.



Stabilising using braces during construction.

The anchors should normally should be prestressed to a certain extent to compensate for the long-term deformations that occur over the course of construction. The anchors are usually fitted storey by storey as the structural frame is built up. As the building is raised up and more and more material is fixed in place, the anchors can lose their tension due to vertical shifting. Once all the storeys are in place, it is therefore essential to check that the anchors are under tension and not loose. If the anchors are loose, they must be tightened up.

Fire safety and sound issues create certain demands in the assembly phase, particularly in multi-storey buildings, which require high acoustic and fire safety standards. Once again, it is important that the construction documents are followed carefully.

10.3 Protecting the structure during construction

10.3.1 Weather protection during construction

The benefits of working under the cover of a full temporary shelter are clear, but some cases require such protection more than others, depending on the nature of the building and the construction method. Depending on the production method and degree of prefabrication, there are different ways to achieve a moisture-proof construction process that takes account of the quality requirements demanded by the client and the authorities in the most cost-effective way. If a building has a high degree of prefabrication and sensitive details, a full temporary shelter is the best alternative overall. On another project with a low degree of prefabrication, a simpler shelter or basic use of tarpaulins may be preferable for financial reasons.

Building without weather protection

If the CLT frame is erected without weather protection, the structure must be temporarily protected with tarpaulins or some other temporary rain cover. This method is best suited to CLT that is built without any form of cladding, as this allows any drying to occur. It also requires good planning concerning drainage, protection of end-grain wood, methods for drying out damp surfaces and follow-up in the form of inspection plans and other documentation.

If the building comprises both floor structures and load-bearing walls in CLT, the walls should be assembled as quickly as possible. This forms a volume that is easier to protect with a plastic or tarpaulin roof until the next floor structure is in place. The top edge of the CLT walls must be protected particularly carefully, since end-grain wood will otherwise be exposed to moisture. In some cases, the finished roof can be used to provide temporary shelter, lifting it off and on. This is mainly applicable if the building is not too large or tall. A construction crane will also usually have to be on site to make this a cost-effective method. The exception is a single-family house, where a hoist will usually suffice. Bear in mind that the roof must be temporarily anchored down to avoid the risk of it blowing off.



Prefabricated wall units being unwrapped for assembly.

Building with weather protection

There are various different systems for weather protection that covers the façade and roof, depending on the situation.

- **Weather protection on façade scaffolding**

Weather protection is achieved by attaching plastic sheeting to the outside of the scaffolding, which is anchored to the structural frame of the building. This solution is suitable for frames with a low degree of prefabrication and frames with more prefabrication, as the weather protection follows the building upwards and can be combined with a roof cover or just a simple temporary floor cover.

This falls outside the Swedish Work Environment Authority's definition of weather protection, but it is still widely used. The sheeting creates considerable windage and it is critical to fully check that the scaffolding is properly anchored in place. When designing fixing points, account must be taken of how the sheeting is attached to the scaffolding. A common method is to attach the sheeting using straps that are designed to give way under a certain load.

- **Fixed or wheeled temporary roofing**

Fixed temporary roofing usually comprises aluminium lattice beams stabilised with struts. The dimensions and load-bearing capacity are crucial in determining how the solution works under wind and snow loads. The frame is covered with PVC sheeting or alternatively with plastic or metal panels.

A wheeled temporary roof is similar to the fixed version, but can be moved on wheels that run on tracks or rails. The weather protection can be split up into sections that can be fully or partly wheeled along the same rails, or that sit on parallel rails, with the sections overlapping one another. The fact that the weather protection can be opened up makes this solution good for lifting in materials.

- **Climbing weather protection**

Climbing weather protection is based on mast structures that follow the building upwards, storey by storey. Climbing weather protection can include suspended working platforms, and also an internal overhead crane to transport materials from the gable ends, replacing the need for an external crane. This type of weather protection has been used on several wood construction projects in Sweden.

10.3.2 Controls and monitoring

Buildings must be designed so that moisture does not cause damage, odours or microbial growth that might affect health and hygiene. This is a responsibility that the developer and the property owner have towards those who use the building, under Boverket's Building Regulations (BBR). To meet this requirement, it is important to conduct regular moisture controls on delivered and assembled construction products. This is usually taken care of by the contractor in the form of on-site inspections.

The on-site inspections should be preceded by a moisture-proofing proposal that states what needs to be checked and what moisture levels may be considered acceptable. This proposal should then be submitted to the person responsible for the inspections, and to



Example with no weather protection, Moholt 5050, Trondheim, Norway.



Tent with crane.



Example of climbing weather protection for dry construction with a high degree of prefabrication.

10.3 Protecting the structure during construction



Elevator shaft of CLT.

the contractor, so that it can be used as the basis for their planning of on-site inspections. The proposal should set out control points for measuring moisture before encasing. Details that should be covered include:

- Which parts of the building should be checked.
- The values for
 - checked moisture levels used in the planning.
 - highest permitted moisture level.
 - critical moisture level.
- A visual inspection before encasing moisture-sensitive materials and products. The moisture levels should be checked by taking measurements and they should not exceed the highest permitted moisture levels. If continued drying is required, this needs to be possible after encasing.

The assessment can be made using the following criteria:

- If the checked moisture level is less than or equal to the highest permitted moisture level, the measurement results fulfil the requirement. A visual check should also be carried out before the control point is approved.
- If the control measurement shows that the highest permitted moisture level is exceeded, but not the critical moisture level, the element should be dried out and a new moisture check carried out before encasing.
- If the control measurement shows that the critical moisture levels are exceeded, a damage check should be carried out and any moisture damage rectified. A new moisture check should then be carried out before encasing.

Measuring moisture

Just like other materials, CLT needs to be stored and handled carefully, a factor that can have a significant impact not only on the design of the structure, but also on the project's finances and planning. CLT is usually wrapped up for delivery in order to protect it from rain, sun, dirt and ground-level moisture in transit, and during storage and assembly.

It is vital to check the moisture content of the material on delivery of the goods, and also over the course of construction if moisture has penetrated into the structure. There are various ways to measure moisture levels, depending on the needs and circumstances.

Table 10.3, page 173, sets out which methods are suitable in different situations. Each method has its pros and cons, but the most common method, and the one best suited to a construction site, is electrical resistance using an electrical resistance moisture meter with insulated hammer electrodes or an attached sensor.

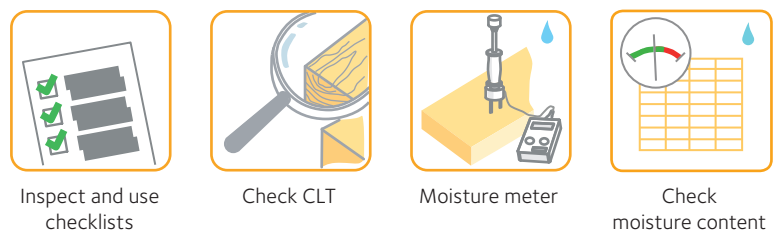

Figure 10.4 Key principles for protecting wood products.

Table 10.3 Different methods of measuring moisture content in CLT.

Measurement method	Value expressed as ¹⁾	Suitable for field measurements	Log	Measures at different depths	Measures moisture content above 25 %	Measures moisture below 5 %	Quick
Capacitance	% MC		x				x
Attached sensor	% MC	x	x	x			x
Electrical resistance	% MC	x	x	x			x
Dry weight method	% MC			x	x	x	
Relative humidity	% MC		x	x		x	

¹⁾ MC = moisture content
Source: Fukt i trä för byggindustrin.

A suggested procedure for measuring using an electrical resistance moisture meter with insulated hammer electrodes is as follows:

- Check that the meter is calibrated using a calibration block.
- Measure the temperature in the wood with the integral temperature sensor or estimate the temperature with a separate thermometer.
- The temperature settings on the meter can then be set to the temperature of the wood. If the instrument does not compensate for temperature, the measurement value must be adjusted afterwards.
- Select wood type.
- Check the moisture content by inserting the electrodes to the required measurement depth. Avoid measuring close to a layer of adhesive. It is recommended to measure around 20 mm up the wall unit, so as not to be measuring the end-grain wood. The extent of the measuring is set out in the planning documents and the results are logged in the inspection plan. If the moisture content is higher than the desired level, regular checks should be carried out during drying until the desired moisture content is achieved.
- When measuring bulky items, it can be difficult to insert long electrodes. It may therefore be necessary to pre-drill holes and then tap in the electrodes for the last centimetre.

Measuring average moisture content of CLT – resistance method.

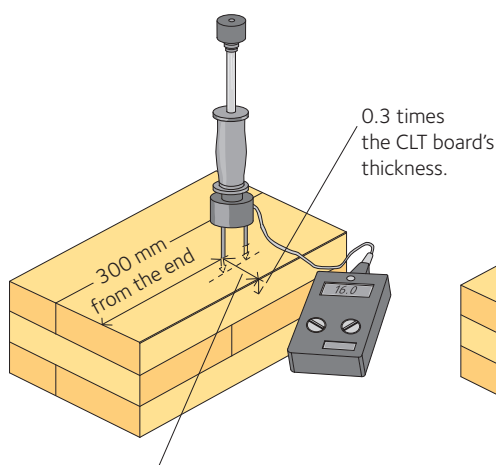

0.3 times the CLT's width from the edge.

Measuring surface moisture content of CLT – lay the electrodes against the surface, parallel with the end.

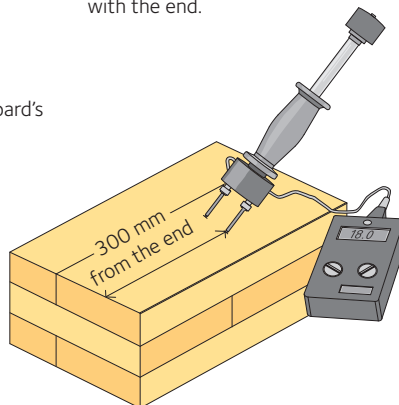

Press the tips of the electrodes down into the sapwood (lighter).

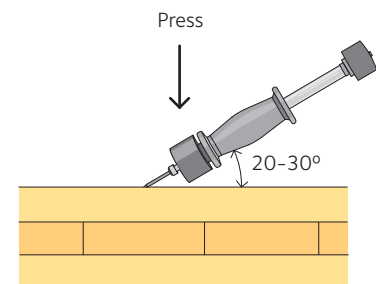

Longitudinal direction of surface board

The lower part of the electrode can be filed down to achieve the correct angle.

Figure 10.5 Measuring average moisture content and surface moisture content.



Assembly roof, Sundbyberg, Sweden.

10.4 Points to bear in mind

Like regular wood, CLT is an organic product that, used correctly, has good natural resistance while also being part of the natural ecocycle. The structure needs to be protected over the intended lifetime of the building, but it is also important that all the materials are protected during construction. To make the checks on the construction material easier, it can be a good idea to have lists of points to bear in mind. Below are some of the points that might apply for CLT.

General

- It is most practical to report moisture in wood as moisture content.
- Moisture absorption and drying via air humidity take around the same time.
- Absorption of free water is much faster than drying, which can only be achieved via air humidity.
- Absorption of free water via end-grain wood is many times faster than via other wood surfaces.
- Moisture-related movement can cause major quality problems. These issues can, however, also occur due to very dry environments.
- A good rule of thumb is that the width and thickness of a piece of timber shrinks or swells 0.25 % per percentage point of moisture content. A CLT member exhibits less moisture-related movement, see figure 1.7, page 20.
- The risk of mould growth can begin at around 75 % relative humidity (RH) if it is very warm. At low temperatures, the relative humidity can be much higher. Mould grows on the surface of wood and does not affect its strength.
- Soiled wood is more likely to see mould growth, since dirt often contains both spores and nutrients.
- The humidity level is not the only factor that affects mould growth. Nutrients in the surface, temperature, pH, UV light, time and the amount of spores also play a role.
- Mould growth can be a precursor to other, more serious attacks.
- Rot can begin to develop when the moisture content in the wood is higher than the fibre saturation point (30 %). The wood-decaying fungi break down the strength of the wood.
- Paint on the surface of wood extends the drying out process. If there are cracks in the paint layer, the wood will easily absorb water during rain, while the drying will take a very long time, leading to fungal growth.

Handling CLT

- When ordering CLT, always state your moisture content requirements.
- Do not use CLT if it has faults.
- Too high a moisture content in the CLT can cause microbial growth, plus checks and deformation can occur.
- CLT may take on moisture in transit and storage, as well as on the construction site. It is therefore important to always carry out an acceptance check.



Protect from precipitation



Use supports and make sure the ground is drained

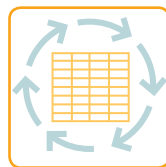

Keep CLT for outdoor use ventilated and protected



Protect from dirt

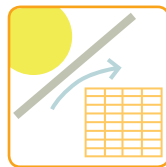

Protect from sun



Check that the packaging is intact

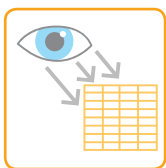

Check the quality



Ventilation under tarpaulin



Stack CLT on stickers if it gets damp



Stack CLT on stickers if it gets damp

Figure 10.6 A few key principles for protecting CLT products.

- Always have an electrical resistance moisture meter with insulated hammer electrodes on site, and carry out acceptance checks and ongoing checks during the construction process.
- CLT that is delivered with a moisture content that is lower than the outdoor climate's equilibrium moisture content should be fully wrapped, or stored in a special area that can retain the low moisture content of the wood – for example a heated storage area or a space with a dehumidifier.
- If a surface is going to be left exposed on completion, it should be handled with care. Avoid walking on the surface, and use clean gloves and lifting slings.

Measuring moisture

- The dry weight method is the reference method for measuring the moisture content.
- Use an electrical resistance moisture meter with insulated hammer electrodes to check the moisture content on the construction site.
- No electrical resistance moisture meter with insulated hammer electrodes can measure moisture contents higher than the fibre saturation point (30 %).
- Low moisture content, such as 6 – 8 %, can be difficult to measure.
- The measurement error in the field, when using an electrical resistance moisture meter with insulated hammer electrodes, is around ± 2.6 % over the whole moisture content span.
- The function of an electrical resistance moisture meter with insulated hammer electrodes should be checked using a calibration block.
- It is recommended that acceptance checks are carried out in two stages:
 - 1) first a simple one, and if this measurement suggests that the moisture content might be off;
 - 2) conduct a more exhaustive measurement.
- The measurement depth varies and generally measurements are taken at several depths in one measuring point. It is not possible to check by touch whether wood is dry. The surface of damp wood can still feel dry to the touch.

Drawing up an inspection plan and choosing measurement points

- Always draw up an inspection plan.
- Work through the questions why, what and how.
- Always make a preliminary assessment of the structure before measuring.
- Tailor the report to the person who will be reading it.
- Ultimately, the choice of measuring points is always determined by conditions on site.
- Always look for the weakest points. Every structure has its own weaknesses, which may not appear in other similar structures.
- Look for the greatest risk of moisture absorption and the poorest drying conditions.
- Measuring moisture in the CLT is just one part of an inspection programme.



Assembly of summer house, Skellefteå, Sweden.

Symbols

Symbol	Explanation
Latin upper case letters	
A	Cross-sectional area
A_{ef}	Effective area of contact surface between a nail plate and the underlying wood; effective contact area with force perpendicular to the grain
A_f	Cross-sectional area of a flange
$A_{net,t}$	Net cross-sectional area perpendicular to the grain
$A_{net,v}$	Net shear area parallel with the grain
C	Spring constant
$E_{0,05}$	Modulus of elasticity, 5 percent fractile
E_d	Modulus of elasticity, design value
E_{mean}	Modulus of elasticity, mean value
$E_{mean,fn}$	Modulus of elasticity, final mean value
F	Force
$F_{A,Ed}$	Design force on a nail plate acting in the centre of gravity of the effective area
$F_{A,min,d}$	Minimum design force on a nail plate acting in the centre of gravity of the effective area
$F_{ax,Ed}$	Design axial force on a fastener
$F_{ax,Rd}$	Design value of the axial withdrawal capacity of the fastener
$F_{ax,Rk}$	Characteristic axial withdrawal capacity of the fastener
F_c	Compressive action or force
F_d	Design value of a force
$F_{d,ser}$	Design force at the serviceability limit state
$F_{f,Rd}$	Design load capacity per fastener in a wall unit
$F_{i,c,Ed}$	Design compressive reaction force at the end of a wall panel
$F_{i,t,Ed}$	Design tensile reaction force at the end of a wall panel
$F_{i,vert,Ed}$	Vertical load on a wall
$F_{i,v,Rd}$	Design resistance under diaphragm action for constituent component i or wall i
F_{la}	Transverse load
$F_{M,Ed}$	Design force from a design moment
F_t	Tensile force
$F_{t,Rk}$	Characteristic value for tensile load capacity of a connection
$F_{v,0,Rk}$	Characteristic load capacity of a screw with washer along the grain
$F_{v,Ed}$	Design shear force per shear plane of fastener; horizontal design effect on a wall panel
$F_{v,Rd}$	Design shear load capacity per shear plane for a fastener; design shear load capacity
$F_{v,Rk}$	Characteristic shear load capacity per shear plane for a fastener

$F_{v,w,Ed}$	Design shear force on web
$F_{x,Ed}$	Design value of a force in the x-direction
$F_{y,Ed}$	Design value of a force in the y-direction
$F_{x,Rd}$	Design value of a plate's load capacity in the x-direction
$F_{y,Rd}$	Design value of a plate's load capacity in the y-direction
$F_{x,Rk}$	The plate's characteristic load capacity in the x-direction
$F_{y,Rk}$	The plate's characteristic load capacity in the y-direction
$G_{0,05}$	Shear modulus, 5 percent fractile
G_d	Shear modulus, design value
G_{mean}	Shear modulus, mean value
H	Total height of a roof truss
I_f	Moment of inertia of a flange
I_{tor}	Torsional moment of inertia
I_z	Torsional moment of inertia about the weaker axis
K_{ser}	Slip modulus
$K_{ser,fn}$	Slip modulus at the final condition
K_u	Slip modulus for the ultimate limit state at the instantaneous condition
$L_{net,t}$	Net width of cross-sectional area perpendicular to the grain
$L_{net,v}$	Net length of failure area under shear stress
$M_{A,Ed}$	Design moment
$M_{ap,d}$	Design moment in the apex zone
M_d	Design moment
$M_{y,Rk}$	Characteristic yield moment of fastener
N	Axial force
$R_{90,d}$	Design splitting capacity
$R_{90,k}$	Characteristic splitting capacity
$R_{ax,d}$	Design load capacity of an axially loaded connection
$R_{ax,k}$	Characteristic load capacity of an axially loaded connection
$R_{ax,\alpha,k}$	Characteristic load capacity at an angle α to the grain
R_d	Design value of load capacity
$R_{ef,k}$	Effective characteristic load capacity of a connection
$R_{iv,d}$	Design shear load capacity of a wall
R_k	Characteristic load capacity
$R_{sp,k}$	Characteristic splitting capacity
$R_{to,k}$	Characteristic load capacity of a serrated washer
$R_{v,d}$	Design shear load capacity of a wall
V	Shear force; volume

V_u, V_l	Shear forces in the upper and lower part of a beam with a hole
W_y	Moment of resistance about the y-axis
X_d	Design value of a material strength property
X_k	Characteristic value of a material strength property
Latin lower case letters	
a	Distance
a_1	Spacing, parallel to the grain, of fasteners within one row
$a_{1,CG}$	Minimum end distance to centre of gravity for wood screws in each section of timber
a_2	Spacing, perpendicular to the grain, between rows of fasteners
$a_{2,CG}$	Minimum edge distance to centre of gravity for wood screws in each section of timber
$a_{3,c}$	Distance between fasteners and an unloaded end
$a_{3,t}$	Distance between fasteners and a loaded end
$a_{4,c}$	Distance between fasteners and an unloaded edge
$a_{4,t}$	Distance between fasteners and a loaded edge
a_{bow}	Maximum initial bow imperfection in a section of timber in a truss
$a_{bow,perm}$	Maximum permitted bow imperfection in a section of timber in a truss
a_{dev}	Maximum positional deviation for a truss
$a_{dev,perm}$	Maximum permitted positional deviation for a truss
b	Width
b_i	Width of panel i or wall i
b_{net}	Clear distance between studs
b_w	Web width
d	Diameter; outer diameter of thread
d_1	Diameter of centre hole of a washer; inner diameter of thread
d_c	Washer diameter
d_{ef}	Effective diameter
d_h	Connector's head diameter
$f_{h,i,k}$	Characteristic embedment strength of timber member i
$f_{a,0,0}$	Characteristic anchorage strength per surface unit for $\alpha = 0^\circ$ and $\beta = 0^\circ$
$f_{a,90,90}$	Characteristic anchorage strength per surface unit for $\alpha = 90^\circ$ and $\beta = 90^\circ$
$f_{a,\alpha,\beta,k}$	Characteristic anchorage strength
$f_{ax,k}$	Characteristic withdrawal strength for the point of a nail; characteristic withdrawal strength
$f_{c,0,d}$	Design compressive strength along the grain
$f_{c,w,d}$	Design compressive strength of a web
$f_{f,c,d}$	Design compressive strength of a flange
$f_{c,90,k}$	Characteristic compressive strength perpendicular to the grain
$f_{f,t,d}$	Design tensile strength of a flange

$f_{h,k}$	Characteristic embedment strength
$f_{head,k}$	Characteristic pull-through strength of fastener
f_1	Fundamental frequency
$f_{m,k}$	Characteristic bending strength
$f_{m,y,d}$	Design bending strength about the principal y-axis
$f_{m,z,d}$	Design bending strength about the principal z-axis
$f_{m,\alpha,d}$	Design bending strength at an angle α to the grain
$f_{t,0,d}$	Design tensile strength along the grain
$f_{t,0,k}$	Characteristic tensile strength along the grain
$f_{t,90,d}$	Design tensile strength perpendicular to the grain
$f_{t,w,d}$	Design tensile strength of the web
$f_{u,k}$	Characteristic tensile strength of screw
$f_{v,0,d}$	Design panel shear strength
$f_{v,\alpha,\alpha,k}$	Characteristic withdrawal strength at an angle α to the grain
$f_{v,\alpha,90,k}$	Characteristic withdrawal strength perpendicular to the grain
$f_{v,d}$	Design shear strength
h	Height; wall height
h_{ap}	Height of the apex zone
h_d	Hole depth
h_e	Embedment depth; distance to loaded edge
h_{ef}	Effective height
$h_{f,c}$	Height of compression flange
$h_{f,t}$	Height of tension flange
$h_{f,l}$	Distance from lower edge of hole to lower edge of component
$h_{f,u}$	Distance from upper edge of hole to upper edge of component
h_w	Web height
i	Notch inclination
$k_{c,y}, k_{c,z}$	Instability factor
k_{cr}	Cracking factor for shear load capacity
k_{crit}	Factor used for lateral buckling
k_d	Dimension factor for a panel
k_{def}	Deformation factor
k_{dis}	Factor for taking account of the stress distribution in an apex zone
$k_{f,1}, k_{f,2}, k_{f,3}$	Correction factors for bracing resistance
k_h	Height factor
$k_{i,q}$	Uniformly distributed load factor
k_m	Factor for the redistribution of bending stresses in a cross-section
k_{mod}	Factor for duration of load and moisture content
k_n	Factor for wall cladding
k_r	Reduction factor

$k_{R,red}$	Reduction factor for load capacity
k_s	Fastener spacing factor; correction factor for spring constant
$k_{s,red}$	Reduction factor for mutual spacing
k_{shape}	Factor depending on the shape of the cross-section
k_{sys}	System strength factor
k_v	Reduction factor for notched beams
k_{vol}	Volume factor
k_y eller k_z	Instability factor
$l_{a,min}$	Minimum anchor length for a glued-in rod
l, L	Span; contact length
l_A	Distance from a hole to the centre line of the component support
l_{ef}	Effective length; effective distribution length
l_V	Distance from a hole to the end of the component
l_z	Centre spacing between holes
m	Mass per unit area
n_{40}	Number of frequencies below 40 Hz
n_{ef}	Effective number of fasteners
p_d	Distributed load
q_i	Equivalent uniformly distributed load
r	Radius of curvature
s	Spacing
s_0	Basic fastener spacing
r_{in}	Inner radius of a curve
t	Thickness
t_{pen}	Penetration depth
u_{creep}	Creep deformation
u_{fin}	Final deformation
$u_{fin,G}$	Final deformation for a permanent action G
$u_{fin,Q,1}$	Final deformation for a leading variable action Q_1
$u_{fin,Q,i}$	Final deformation for accompanying variable actions Q_i
u_{inst}	Instantaneous deformation
$u_{inst,G}$	Instantaneous deformation for a permanent action G
$u_{inst,Q,1}$	Instantaneous deformation for a leading variable action Q_1
$u_{inst,Q,i}$	Instantaneous deformation for accompanying variable actions Q_i
w_c	Pre-camber
w_{creep}	Creep deflection
w_{fin}	Final deflection
w_{inst}	Instantaneous deflection
$w_{net,fin}$	Net final deflection
v	Unit impulse velocity response

Greek lower case letters	
α	Angle between x-direction and force in a nail plate; angle between force and grain; angle between load and edge (or ends) subject to load
β	Angle between grain and force for a nail plate
β_c	Straightness factor
γ	Angle between the x-direction for a nail plate and the main direction of the wooden
γ_M	Partial factor for material properties also accounting for model uncertainties and dimensional variations
λ_y	Slenderness ratio for bending about the y-axis
λ_z	Slenderness ratio for bending about the z-axis
$\lambda_{rel,y}$	Relative slenderness ratio for bending about the y-axis
$\lambda_{rel,z}$	Relative slenderness ratio for bending about the z-axis
ρ_k	Characteristic density
ρ_m	Mean density
$\sigma_{c,0,d}$	Design compressive stress along the grain
$\sigma_{c,\alpha,d}$	Design compressive stress at an angle α to the grain
$\sigma_{f,c,d}$	Mean design compressive stress in a flange
$\sigma_{f,c,max,d}$	Design compressive stress of the extreme fibres in a flange
$\sigma_{f,t,d}$	Mean design tensile stress in a flange
$\sigma_{f,t,max,d}$	Design tensile strength of the extreme fibres in a flange
$\sigma_{m,crit}$	Critical bending stress
$\sigma_{m,y,d}$	Design bending stress about the principal y-axis
$\sigma_{m,z,d}$	Design bending stress about the principal z-axis
$\sigma_{m,\alpha,d}$	Design bending stress at an angle α to the grain
σ_N	Normal stress
$\sigma_{t,0,d}$	Design tensile stress along the grain
$\sigma_{t,90,d}$	Design tensile stress perpendicular to the grain
$\sigma_{w,c,d}$	Design compressive stress in a web
$\sigma_{w,t,d}$	Design tensile stress in a web
τ_d	Design shear stress
$\tau_{F,d}$	Design anchor stress, axial force
$\tau_{M,d}$	Design anchor stress, moment
$\tau_{tor,d}$	Design torsional shear stress
ψ_0	Factor for the combination value of variable actions
ψ_1	Factor for the frequent value of a variable action
ψ_2	Factor for the quasi-permanent value of a variable action
ζ	Relative damping

CLT-specific	
$A_{x,net}$	Net cross-sectional area normal, x-axis
$A_{y,net}$	Net cross-sectional area normal, y-axis
$f_{c,0,x,k}$	Characteristic compressive strength of panel along x-axis.
$f_{c,0,y,k}$	Characteristic compressive strength of panel along y-axis.
$f_{c,90,xy,k}$	Characteristic compressive strength perpendicular to the plane of the panel
$G_{R,mean}$	Rolling shear modulus, mean value
$f_{m,x,k}$	Characteristic bending strength of CLT panel in global x-direction.
$f_{m,y,k}$	Characteristic bending strength of CLT panel in global y-direction.
$f_{t,0,x,k}$	Characteristic tensile strength of panel in global x-direction.
$f_{t,0,y,k}$	Characteristic tensile strength of panel in global y-direction.
$f_{t,90,x,k}$ $f_{t,90,y,k}$	Characteristic tensile strength perpendicular to the plane of the panel
$f_{c,0,xlay,k}$	Characteristic compressive strength along the grain for boards in the global x-direction.
$f_{c,0,ylay,k}$	Characteristic compressive strength along the grain for boards in the global y-direction.
$f_{c,90,xlay,k}$	Characteristic compressive strength perpendicular to the grain for boards in the global x-direction.
$f_{c,90,ylay,k}$	Characteristic compressive strength perpendicular to the grain for boards in the global y-direction.
$f_{m,xlay,k}$	Characteristic bending strength for boards in the global x-direction.
$f_{m,ylay,k}$	Characteristic bending strength for boards in the global y-direction.
$f_{t,0,xlay,k}$	Characteristic tensile strength for boards in the global x-direction.
$f_{t,0,ylay,k}$	Characteristic tensile strength for boards in the global y-direction.
$f_{v,090,xlay,k}$	Characteristic shear strength for longitudinal boards in the x-direction
$f_{v,090,ylay,k}$	Characteristic shear strength for longitudinal boards in the y-direction
$f_{v,9090,xlay,k}$	Characteristic shear strength for transverse boards in the x-direction
$f_{v,9090,ylay,k}$	Characteristic shear strength for transverse boards in the y-direction
$E_{0,x,mean}$	Mean modulus of elasticity for a panel in the global x-direction

$E_{90,x,mean}$	Mean modulus of elasticity for a panel perpendicular to the global x-direction
$E_{0,y,mean}$	Mean modulus of elasticity for a panel in the global y-direction
$E_{90,y,mean}$	Mean modulus of elasticity for a panel perpendicular to the global y-direction
$E_{0,x,0,05}$	Modulus of elasticity's 5 percent fractile for a panel in the global x-direction
$E_{0,y,0,05}$	Modulus of elasticity's 5 percent fractile for a panel in the global y-direction
$G_{090,xlay,mean}$	Mean shear modulus along boards in the global x-direction
$G_{090,ylay,mean}$	Mean shear modulus along boards in the global y-direction
$G_{9090,xlay,mean}$	Mean shear modulus along boards in the global x-direction (rolling shear modulus)
$G_{9090,ylay,mean}$	Mean shear modulus along boards in the global y-direction (rolling shear modulus)
$I_{t,0,CLT}$	Torsional moment of inertia about the x-axis
$I_{t,90,CLT}$	Torsional moment of inertia about the y-axis
$I_{x,net}$	Net moment of inertia for deflection about the y-axis
$I_{y,net}$	Net moment of inertia for deflection about the x-axis
$I_{x,ef}$	Effective moment of inertia for deflection about the y-axis
$I_{y,ef}$	Effective moment of inertia for deflection about the x-axis
$i_{x,ef}$	Effective radius of gyration for deflection about the y-axis
$i_{y,ef}$	Effective radius of gyration for deflection about the x-axis
κ_x	Shear correction factor equating to deflection about the y-axis
κ_y	Shear correction factor equating to deflection about the x-axis
$S_{x,net}$	Net static moment or net shear resistance
$S_{y,net}$	Net static moment or net shear resistance



Ceiling of CLT on load-bearing glulam.

Bibliography

General

- Boverkets byggregler, BFS 2011:6 med ändringar t.o.m. BFS 2015:3. Boverkets författningssamling, BFS 2015:6 EKS 10.
- BSP handbuch, Holz-Massivbauweise in Brettsperrholz, 2010. CLT handbook, FP Innovation, Canada, 2011.
- Focus Solid Timber Solutions – European Conference on Cross Laminated Timber, Graz, 2013.
- Handbok – Bygge med Massivtreelement, Norsk Treteknisk Institutt, 2007.
- Massivträ. Handboken, Industrikonsortiet Massivträ, 2002.
- Wallner-Novak M., Koppelhuber J., Pock K.: Cross-Laminated Timber Structural Design, Basic design and engineering principles according to Eurocode, pro:Holz, 2014.

Chapter 1 – CLT as a construction material

- Eriksson P.: Comparative LCAs for wood and other construction methods, Proceedings of the 8th WCTE, Lahti, Finland, 2004.
- Gustafsson A., Eriksson P-E., Engström S., Wik T., Serrano E.: Handbok för beställare och projektörer av flervånings bostadshus i trä. SP report 2012:70, 2013.
- Peñaloza D., Norén J., Eriksson P.: Life Cycle Assessment of Different Building Systems: The Wälluden Case Study, SP Report 2013:07, 2013.

Chapter 2 – Construction systems for CLT

- Betjka I., Lam F.: Cross laminated timber as innovative building material. Proceedings of the CSCE Annual Conference in Quebec, Canadian Society for Civil Engineering, 2008.
- Schickhofer G.: Cross Laminated Timber (CLT) in Europe – from Conception to Implementation, presentation, University of British Columbia, Department of Wood, Science, Vancouver, Canada 2010.

Chapter 3 – Designing structures in CLT

- Fellmoser P., Blass H.J.: Influence of rolling shear modulus on strength and stiffness of structural bonded timber elements. In Proceeding of CIB-W18 Meeting, Edinburgh, 2004.
- Schickhofer G., Bogensperger T., Moosbrugger T.: BSPhandbuch – Holz-Massivbauweise in Brettsperrholz, Nachweise auf Basis des neuen europäischen Normenkonzepts, 2. Auflage, Graz: Verlag der Technischen Universität Graz, 2010.

Chapter 4 – Joints and connections

- Uibel T., Blass H.J.: Load carrying capacity of joints with dowel type fasteners in solid wood panels, Paper presented at the 40th meeting of the Working Commission W18-Timber Structures, International Council for Research and Innovation in Building and Construction, Bled, Slovenia, 2007.
- Uibel T., Blass H.J.: Edge joints with dowel type fasteners in solid wood panels, Paper presented at the 40th meeting of the Working Commission W18-Timber Structures, International Council for Research and Innovation in Building and Construction, Bled, Slovenia, 2007.
- Wallner-Novak M., Koppelhuber J., Pock K.: Cross-Laminated Timber Structural Design, Basic design and engineering principles according to Eurocode, pro:Holz, 2014.

Chapter 5 – Floor structures

Blass H.J., Ehlebeck J., Kreuzinger H., Steck, G.: Erläuterungen zu DIN 1052:2004-08; Entwurf, Berechnung und Bemessung von Holzbauwerken, 1. Auflage, Hrsg.: DGfH Innovations- und Service GmbH, München, 2004.

Östman et al: Brandsäkra trähus – Nordisk-baltisk kunskapsöversikt och vägledning, version 3

Hamm P., Richter A.: Personeninduzierte Schwingungen bei Holzdecken – Neue Erkenntnisse führen zu neuen Bemessungsregeln, Ingenieurholzbau – Karlsruher Tage: Forschung für die Praxis, Universität Karlsruhe, 2009.

Ohlsson S.: Serviceability criteria – especially floor vibrations criteria. 1991 International timber engineering conference. TRADA vol.1 58–65, 1991.

Ohlsson S.: Svikt, svängningar och styvhet hos bjälklag – dimensioneringsmetoder, 1994.

Chapter 6 – Walls

Associerede Ingeniører ApS: Massivtræ i byggeriet, Træbranchens Oplysningsråd, 2001.

Bergdahl U., Ottosson E., Stigson Malmberg B.: Plattgrundläggning, SGI, Svensk Byggtjänst, 1993.

Olsson C., Holm G.: Pålgrundläggning, SIG, Svensk Byggtjänst, 1993.

Chapter 7 – CLT and fire safety

Boverkets allmänna råd om brandbelastning, BFS 2013:11 – BBRBE 1.

BrandEx Brandtätningar AB, Brandtätningar, <http://www.brandex.se/brandtatningar.asp> [14.02.2013], 2013.

Brandskydd, Passivt brandskydd ofta beroende av rätt byggmaterial, <http://brandskydd.tv/2012/08/10/passivt-brandskydd-ofta-beroende-av-ratt-byggmaterial>, [08.05.2013], 2012.

Eriksson P-E, Nord T och Östman, B: Kartläggning av brandincidenter i flervåningshus med trästomme – Erfarenheter från 20 års brukande, SP Report 2016:12, 2016.

Klippel M., Schmid J., Frangi A.: Fire Design of CLT, pp 101–122 in Proceedings of the Joint Conference of COST Actions FP1402 & 1404. Cross Laminated Timber – A competitive wood product for visionary and fire safe buildings. KTH Building Materials, Stockholm 10 March 2016.

Schaffer E.L.: Charring rate of selected woods – transverse to grain. US Department of Agriculture, Forest Service, Forest Products Laboratory, Research paper FPL 69, Madison, USA, 1967.

Stein R., Werther N., Winter S.: Konstruktionskatalog für Gebäude in Holzbauweise unter Berücksichtigung bauordnungsrechtlicher und versicherungstechnischer Aspekte. Technische Universität München, 2013.

Teibinger M., Matzinger I.: Fire-resistant sealing in timber construction. Planning brochure. Issue 38 of the HFA Schriftreihe, Holzforschung Austria, 2012.

Östman, Mikkola, Stein, Frangi, König, Dhima, Hakkarainen, Bregulla: Fire safety in timber buildings. Technical guideline for Europe. SP Report 2010:19, Stockholm, 2010.

Östman et al: Brandsäkra trähus – Nordisk-baltisk kunskapsöversikt och vägledning, version 3, SP Report 2012:18, Stockholm, 2012.

Chapter 8 – CLT and acoustic

Bostäder och nya ljudkrav, Boverkets Byggekostnadsforum, 2007.

Hagberg K.: Tre exempel på akustiklösningar i träbyggande. En skrift för små och medelstora byggföretag som vill bygga med lätta stomsystem, SBUF, 2013.

Larsson K., Simmons C.: Vägledning för mätning av ljudnivå i rum med stöd av SS_EN ISO 10052/16032, SP report 2015:2, 2015.

Ljunggren F.: Arbetsrapport Nr 20, Ljud- och vibrationsmätningar i testhus, Luleå University of Technology, 2016.

Ljunggren S.: Ljudisolering i trähus – en handbok för konstruktörer. SP Report 2011:10, 2011

Chapter 9 – CLT, heat and moisture

Construction with Cross-Laminated Timber in Multi-Storey Buildings, Guidelines, Holz Forschung Austria, 2013.

Hagentoft C-E.: Introduction to Building Physics, 2001.

Holzbausysteme, Arbeitsgemeinschaft Holz e.V. Duesseldorf, 2000.

Ståhl F.: Thermal properties of building materials and their influence on the energy efficiency, 2009.

Werner: Brettstapelbauweise. Arbeitsgemeinschaft Holz e.V. Duesseldorf.

Chapter 10 – Purchasing and assembly

Esping B., Salin J-G., Brander P.: Fukt i trä för byggindustrin, Fuktegenskaper, krav, hantering och mätning, SP Träteknik, 2005.

Van Riemsdijk J.: Lyftredskap för KL-trä, hantering av horisontella och vertikala element i massivträ, 2014.

Degree project Chalmers University of Technology, 2014:23

References for standards

SS 25267:2015 Acoustics – Sound classification of spaces in buildings – Dwellings, SIS Förlag AB ,2015.

SS 25268 Acoustics – Sound classification of spaces in buildings – Institutional premises, rooms for education, preschools and leisure-time centres, rooms for office work and hotels, SISA Förlag AB, 2007

SS-EN 338:2016 Structural timber – Strength classes, SIS Förlag AB, 2016

SS-EN 1990/A1:2005/AC:2010 Eurocode – Basis of structural design, SIS Förlag AB, 2010

SS-EN 1991-1-1/AC:2009, Eurocode 1: Actions on structures- Part 1-1: General actions – Densities, self-weight, imposed loads for buildings, SIS Förlag AB, 2009.

SS-EN 1992-1-1:2005/A1:2014, Eurocode 2: Design of concrete structures- Part 1-1: General rules and rules for buildings, SIS Förlag AB, 2014.

SS-EN 1993-1-1:2005/AC:2009, Eurocode 3: Design of steel structures- Part 1-1: General rules and rules for buildings, SIS Förlag AB, 2009.

SS-EN 1994-1-2:2005, Eurocode 4: Design of composite steel and concrete structures – Part 1-2: General rules – Structural fire design, SIS Förlag AB, 2008.

SS-EN 1995-1-1:2004/A2:2014: Design of timber structures – Part 1-1: General – Common rules and rules for buildings, SIS Förlag AB, 2014.

SS-EN 1995-1-2:2004/AC:2010: Design of timber structures – Part 1-2: General – Structural fire design, SIS Förlag AB, 2010.

SS-EN 13017-1:2001 Solid wood panels. Classification by surface appearance. Solid wood panels – Part 1: Softwood, SIS Förlag AB, 2001.

SS-EN 13501-1:2007+A1:2009 Fire classification of construction products and building elements – Part 2: Classification using test data from reaction to fire tests. SIS Förlag AB, 2009.

SS-EN 13501-2: 2007+A1:2009 Fire classification of construction products and building elements – Part 2: Classification using data from fire resistance tests, excluding ventilation services. SIS Förlag AB, 2009.

SS-EN 14080:2013 Timber structures. Glued laminated timber and glued solid timber. Requirements, SIS Förlag AB, 2013.

SS-EN 14081-1:2016 Timber structures. Strength graded structural timber with rectangular cross section – Part 1: General requirements, SIS Förlag AB, 2016.

SS-EN 15804:2012 Sustainability of construction works. Environmental product declarations. Core rules for the product category of construction products, SIS Förlag AB, 2013.

SS-EN 15978:2011 Sustainability of construction works. Assessment of environmental performance of buildings – Calculation method, SIS Förlag AB, 2016.

SS-EN 16351:2015 Timber structures. Cross laminated timber. Requirements, SIS Förlag AB 2015.

- SS-EN ISO 717-1:2013. Acoustics – Rating of sound insulation in buildings and of building elements – Part 1: Airborne sound insulation, SIS Förlag AB, 2013.
- SS-EN ISO 717-2:2013. Acoustics – Rating of sound insulation in buildings and of building elements – Part 2: Impact sound insulation, SIS Förlag AB, 2013.
- SS-EN ISO 3382-2:2008/AC:2009. Acoustics – Measurement of room acoustic parameters – Part 2: Reverberation time in ordinary rooms, SIS Förlag AB, 2009.
- SS-EN ISO 6946:2007. Building components and building elements – Thermal resistance and thermal transmittance – Calculation method, SIS Förlag AB 2007.
- SS-EN ISO 9001:2008/AC:2009. Quality management systems – Requirements, SIS Förlag AB, 2009.
- SS-EN ISO 14001:2015. Environmental management systems – Requirements with guidance for use, SIS Förlag AB, 2015.
- SS-EN ISO 14040:2006. Environmental management – Life cycle assessment – Principles and framework, SIS Förlag AB, 2006.
- SS-EN ISO 14044:2006. Environmental management – Life cycle assessment – Requirements and guidelines, SIS Förlag AB, 2006.
- SS-EN ISO 14025:2010. Environmental labels and declarations – Type III environmental declarations – Principals and procedures, SIS Förlag AB, 2010.
- SS-EN ISO 16032:2004. Acoustics – Measurement of sound pressure level from service equipment in buildings – Engineering method, 2004.
- SS-EN ISO 16283:2014 Acoustics – Field measurement of sound insulation in buildings and of building elements – Part 1: Airborne sound insulation (ISO 16283-1:2014), 2014.
- SS-EN ISO 16283-2:2015. Acoustics – Field measurement of sound insulation in buildings and of building elements – Part 2: Impact sound insulation, 2015.

Non-liability

By using the content of *The CLT Handbook*, you agree to the terms of use below. All information in *The CLT Handbook* is provided for information purposes only and should not be seen as entering into an advisory or professional relationship with the reader.

All information is provided in its present state and without any form of guarantee, to the extent permitted by prevailing legislation. Although the publisher has taken all reasonable steps to try and provide reliable information in *The CLT Handbook*, the publisher does not guarantee that the content is free from errors, mistakes and/or omissions, or that the content is up to date and relevant to the user's needs.

The publisher, Föreningen Sveriges Skogsindustrier, also provides no guarantees for any outcomes arising from use of the information contained in *The CLT Handbook*. All use of information in *The CLT Handbook* is the user's own responsibility and is done at the user's risk.

Föreningen Sveriges Skogsindustrier owns the rights to the content of *The CLT Handbook*. The content is protected under copyright law. Misuse will be subject to a penalty. Copying of the content is prohibited.

Föreningen Sveriges Skogsindustrier accepts no liability for any damage or injury that may arise due to the content of *The CLT Handbook*.



Interior with CLT and glulam.

The CLT Handbook

© Föreningen Sveriges Skogsindustrier,
2019 First edition

Publisher

Skogsindustrierna
Svenskt Trä
Box 55525
102 04 STOCKHOLM
Tel: 08-762 72 60
Fax: 08-762 79 90
E-post: info@svenskttra.se
www.svenskttra.se

Project managers

Johan Fröbel – Swedish Wood
Anders Gustafsson – RISE Research Institutes of Sweden

Editors

Eric Borgström – Swedish Wood
Johan Fröbel – Swedish Wood

Lead author

Anders Gustafsson – RISE Research Institutes of Sweden

Co-authors

Roberto Crocetti – Faculty of Engineering, Lund University
Alar Just – RISE Research Institutes of Sweden
Pierre Landel – RISE Research Institutes of Sweden
Jörgen Olsson – RISE Research Institutes of Sweden
Anna Pousette – RISE Research Institutes of Sweden
Magnus Silfverhielm – AIX Arkitekter
Birgit Östman – Linnaeus University

Reference group and fact checkers

Eric Borgström – Swedish Wood
Henrik Danielsson – Limträteknik i Falun AB/ Faculty of Engineering, Lund University
Mattias Brännström – Renewinn AB
Mats Ekevad – Luleå University of Technology
Johan Fröbel – Swedish Wood
Melker Johansson – Tyréns AB
Thomas Johansson – Moelven Töreboda AB
Rune Karlsson – Rune Karlsson Byggprojektering i Hedemora
Greger Lindgren – Martinsons Group AB
Daniel Wilded – Martinsons Group AB

Contributors

Bengt Friberg – ProService Kommunikation AB
Lotta Olsson – ProService Kommunikation AB
Marie Åsell – Swedish Wood

Illustrations

Vendela Martinac – Thelander Arkitektur & Design AB
Cornelia Thelander – Thelander Arkitektur & Design AB

Foto

Photos
Johan Ardefors, page 42
baraBild, page 61, 95, 140, 157
Per Bergqvist, page 32, 35, 106, 120, 129, 144, 156, 174
Eric Bogström, page 19, 31
Mattias Brännström, page 41, 62, 80 lower, 87
Patrik Degerman, page 7, 15, 21 table, 71, 96, 100, 114, 172
Tommy Durath, page 66
Åke E.son Lindman, page 9, 34, 45, 51 lower, 86, 90, 108, 109, 112, 142
Mats Ekevad, page 23 lower right, 25 lower
Andreas Falk, page 24
Johan Fröbel, page 165 lower
Anders Gustafsson, page 16, 17, 22 upper, 25 upper, 37, 85, 93, 111, 141, 143, 146, 170, 171 middle
Kennet Gustafsson, page 165 upper
Tomas Gustafsson, page 161, 167 right
Thomas Harrysson, page 23 lower left, 67
Svanthe Harström, page 11 Bertil Hertzberg, page 21 upper
Holzbau Unterrainer, page 160
Sören Håkanlind, page 60
Peter Jacobsson, page 152
Joakim Kröger, page 23 upper
Per Kårehed, page 135
Pierre Landel, page 21 lower, 26 upper
LEVA Husfabrik, page 22 lower left
Bengt Lind, page 8
Peter Lindbom, page 39, 180
Jonas Lundqvist, page 83, 175
Martinson, page 4, 63, 166, 167 left
Murman Architects, page 48
Per Myrehed, page 22 lower right
Hideyuki Nasu, page 171 lower
Rasmus Norlander, page 1
Jimmy Ruljeff, page 150
Dagfinn Sagen, page 171 upper
Magnus Silfverhielm, page 10
Skanska, page 169
Swedish Wood, page 13, 14
Stora Enso, page 18, 27, 51 upper, 65, 74, 80 upper, 82, 97, 113, 132, 136, 163, 168, 185
Synlig.no, page 134
David Valldeby, page 98
Birgit Östman, page 26 upper

Graphic design and production

ProService Kommunikation AB

ISBN 978-91-983214-4-3

Publications and websites from Swedish Wood

Publications

Order via www.swedishwood.com/publications.

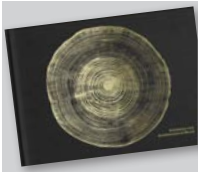

Architecture in wood
Presentation of the shortlisted entries from the 2016 Timber Prize.
In English/Swedish.
168 pages. Format A4.

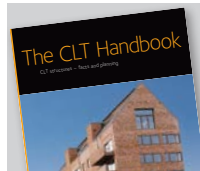

The CLT Handbook
CLT structures – facts and planning.
In English/Swedish.
188 pages. Format A4.

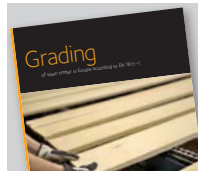

Grading
A guide about sawn timber in Europe according to EN 1611-1.
Also in Swedish.
84 pages. Format A5.

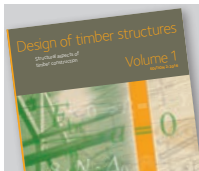

Design of timber structures Volume 1
Structural aspects of timber construction.
Also in Swedish.
316 pages. Format A4.

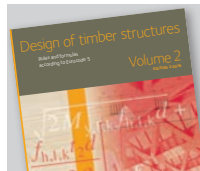

Design of timber structures Volume 2
Rules and formulas according to Euro-code 5. Also in Swedish.
64 pages. Format A4.

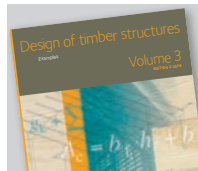

Design of timber structures Volume 3
Examples.
Also in Swedish.
64 pages. Format A4.

Websites



www.swedishwood.com



www.woodcampus.co.uk



Swedish Wood works to promote knowledge, inspiration and development in the field of wood, wood products and wood construction. The aim is to increase the use of wood in Sweden and in selected markets abroad through information and inspiration. Swedish Wood also focuses on raising the profile of wood as a competitive, ecofriendly and sustainable material.

Swedish Wood operates under the auspices of **The Swedish Forest Industries Federation**. Swedish Wood is supported by the Swedish sawmill and glulam industry.

© Föreningen Sveriges Skogsindustrier, 2019.

Box 55525
102 04 Stockholm
Tel: 08-762 72 60
Fax: 08-762 79 90
info@svenskttra.se
svenskttra.se



ISBN 978-91-983214-4-3